



Safety Equipment

Catalogue valid as of January 1, 2019



Brings the invisible to light
 Wireless inspection camera for systems up to 123 kV

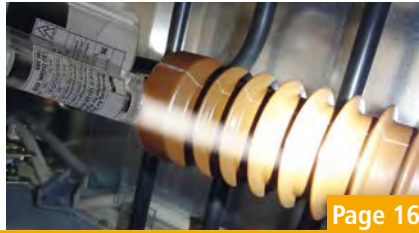

Page 16

New Products



Now I am safe!
 It reliably protects me up to 1,000 bar

Now with branding service:

Individualise your PPE (from 10 items off) with company logo and name of the wearer.



Page 141



An adapter makes it easy
 Quick installation of the animal guard on overhead lines

Page 177

General Terms And Conditions

Our General Terms and Conditions in the current version (under www.dehn-international.com) apply for deliveries and services.

Foreword

New products	Cover
DEHN protects.®	3
DEHN – International	4
DEHN – Information	5

**Working According to The Five Safety Rules 8**

1. Disconnect completely – Operating sticks, wireless inspection camera	9
2. Secure against re-connection – Lock-out systems	21
3. Verify that the installation is dead – DEHNcheck voltage detectors	23
3. Verify that the installation is dead – DEHNcheck phase comparators	45
3. Verify that the installation is dead – DEHNcap voltage detecting system	47
4. Carry out earthing and short-circuiting – EaS devices	53
5. Provide protection against adjacent live parts – Insulating protective shutters	111

**Live Working 115**

Cleaning equipment	116
Protective and auxiliary equipment	123

Arc Fault Protection 127

Passive arc fault protection	128
Active arc fault protection	135

Products for Protection Against High-Pressure Water Jets 139**Service and Safety 145****Further Equipment 147**

Measuring device	148
VLD voltage limiting devices	149
Barrier	151
Discharge devices and equipotential bonding devices	153
Storage bags and transport cases	158
Accessories	163
Spare parts	168
Kit parts	169

Index 179

Part no. index	179
Variant no. index	186
Type index	187
Notes	191
Key words	192

Safety Equipment Main Catalogue valid as of January 1, 2019

This catalogue replaces the Main Catalogue Safety Equipment 2017.

We reserve the right to introduce changes in configuration and technology, dimensions, weights and materials within the scope of technical progress. Illustrations are not binding. We accept no liability for misprints, modifications and errors. Any reproduction of this catalogue, as a whole or in parts, is only allowed upon approval of DEHN.



Our promise



"We are a reliable partner for our customers and employees."

Dr Philipp Dehn
Managing Partner / CEO

DEHN protects.®

Dear business associates,

Our family-run business stands for safety and pioneering spirit in all matters of lightning and surge protection and safety equipment. Increasingly complex technical innovations and networks require enhanced protection.

We offer you the added value of readily available protective components, equipment, solutions and services of consistently high quality. You can rely on us, your worldwide partner for lightning and surge protection and safety equipment, to provide the best possible service.

We think ahead and ensure that the solutions we find with you today are also fit to meet the requirements of tomorrow. We invest in the future to give you a real competitive edge, e.g. our high-voltage-resistant insulated down conductor, the HVI® Conductor which is tailored to your applications, our ACI (Advanced Circuit Interruption), an innovative surge protection technology, or our sophisticated safety equipment. We are currently active in the field of occupational safety with high-pressure water jets and have already designed a completely new protective overall.

With heart and mind, passion and pioneering spirit, we drive forward developments in surge and lightning protection and safety equipment.

Digital transformation touches all aspects of our lives. We want to be your partner when it comes to protecting trend-setting smart energy and data solutions because all intelligent components have one thing in common: the sensitive "smart" electronics need protecting against the effects of lightning and surges. This applies to all electrically conductive systems, i.e. both power technology and information and communications technology. Let us combine our products, services and expertise with your protection requirements to create a tangible benefit for you and for us. We want to create a safer environment for you with new protection solutions to fit the continuously developing technology.

Take advantage of what we have on offer in terms of lightning and surge protection and safety equipment and help us to make the world just that little bit safer. I look forward to your interest and the chance to work with you!

Your
Dr Philipp Dehn



"Our customers are the focal point of our activities."

Helmut Pusch
Managing Director / CSO

Shared success

Our goal is to combine our products, solutions and expertise in such a way that the benefits are tangible, both for you and us. DEHN provides intelligent and sustainable protective solutions to meet your current and future requirements. We are your fair and reliable global partner. On- and offline we help you by providing information and comprehensive support. Strong sales teams, a network of 20 foreign subsidiaries and representative offices, and more than 70 sales partners worldwide are at your side for the purpose. We are particularly committed to imparting knowledge. We pass on our practical expertise on products and solutions through the hundreds of seminars, workshops, training sessions and conferences held annually and, not least, through our book the 'Lightning Protection Guide'. You, the customer, profit from our solutions and keep your finger on the pulse of time in terms of future protection solutions and requirements. Let us work together to make the increasingly complex and digital world just that little bit safer.

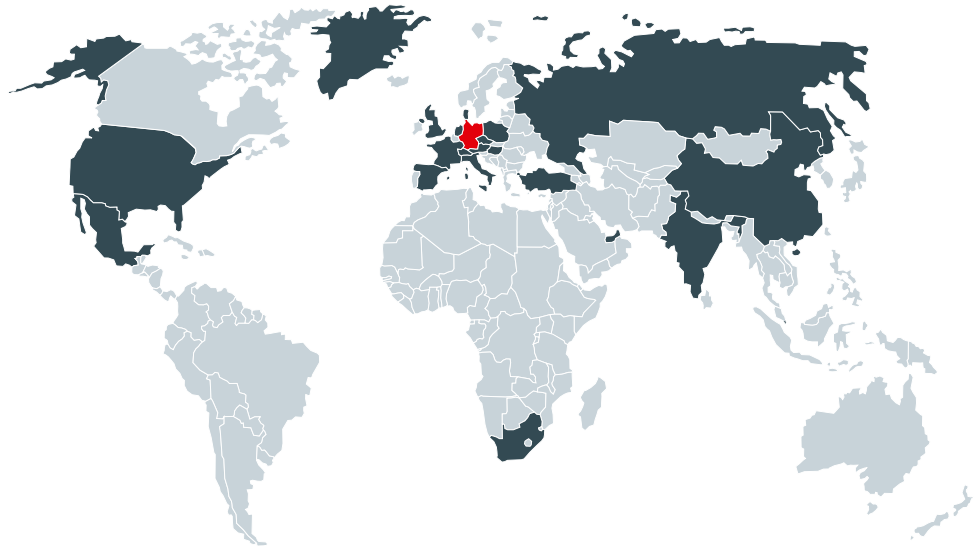

DEHN + SÖHNE GmbH + Co.KG.

Customer Service Center

Commercial customer service
sales@dehn.de
Tel. +49 9181 906 1547
Fax +49 9181 906 1444

Technical Support
itss@dehn.de
Tel. +49 9181 906 1510
Fax +49 9181 906 1444

Subsidiaries and representative offices

Austria:	DEHN AUSTRIA GmbH	www.dehn.at
China:	DEHN Surge Protection (Shanghai) Co. Ltd.	www.dehn.cn
Czech Republic:	DEHN s.r.o.	www.dehn.cz
Denmark:	DESITEK A/S	www.desitek.dk
France:	DEHN FRANCE S.à.r.l.	www.dehn.fr
Great Britain:	DEHN (U.K.) LTD.	www.dehn.co.uk
Hungary:	DEHN office Budapest	www.dehn.hu
India:	DEHN INDIA Pvt. Ltd.	www.dehn.in
Italy:	DEHN ITALIA S.p.A.	www.dehn.it
Mexico:	DEHN PROTECTION MÉXICO, S.A. de C.V.	www.dehn.mx
Netherlands:	DEHN NEDERLAND B.V.	www.dehn.nl
Poland:	DEHN POLSKA Sp. z o.o.	www.dehn.pl
Russia:	OOO DEHN RUS	www.dehn-ru.com
Singapore:	DEHN (SEA) PTE. LTD.	www.dehn.sg
South Africa:	DEHN AFRICA (Pty) Ltd.	www.dehn-africa.com
Spain:	DEHN IBÉRICA Protecciones Eléctrica, S.A. Unipersonal	www.dehn.es
Switzerland:	ELVATEC AG	www.elvatec.ch
Turkey:	DEHN office Istanbul	www.dehn.com.tr
United Arab Emirates:	DEHN MIDDLE EAST FZE	www.dehn.ae
USA:	DEHN Inc.	www.dehn-usa.com

Sales activities in more than 70 countries worldwide

You can find your current local contact person on the Internet at:
www.dehn-international.com/en/contact

1. VDE standards for safety equipment and devices

DIN VDE 0680

"Personal protective equipment, protective devices and apparatus for work on electrically energized systems up to 1000 V".

- Part 1 "Protective insulating devices"
- Part 3 "Operating rods and current collecting devices"
- Part 4 "Fuse handles for low-tension HRC-fuses"
- Part 6 "Single-pole voltage tester up to 250 V a.c."
- Part 7 "Socket spanner"

DIN VDE V 0681

"Live working – Devices for operating and testing with nominal voltages exceeding 1 kV".

- Part 1 "General requirements" for DIN VDE V 0681 Part 2 to Part 3
- Part 2 "Specifications for switching sticks"
- Part 3 "Specifications for fuse tongs"

"Operating and testing devices for work and safe guarding on electrical systems with rated voltages exceeding 1 kV, voltage detectors to be used for overhead contact systems 15 kV, 16 ²/₃ Hz."

- Part 6 "Voltage detectors for overhead contact systems of electric railways"
(DIN VDE 0681-6)

DIN VDE 0682

"Live working"

- Part 201 "Hand tools for use up to 1000 V a.c. and 1500 V d.c."
(IEC/EN 60900)
- Part 211 "Insulating sticks and attachable devices –
Part 1: Insulating sticks"
(IEC 60832-1:2010)
- Part 212 "Insulating sticks and attachable devices –
Part 2: Attachable devices"
(IEC 60832-2:2010)
- Part 213 "Multi-purpose insulating sticks for electrical operations on
high voltage installations"
(EN 50508)
- Part 311 "Gloves of insulating material"
(IEC/EN 60903)
- Part 312 "Sleeves of insulating material for live working"
(IEC/EN 60984)
- Part 321 "Electrically insulating helmets for use on low voltage
installations"
(EN 50365)
- Part 401 "Two-pole low voltage type"
(IEC/EN 61243-3)

- Part 411 "Capacitive type to be used for voltages exceeding 1 kV a.c."
(IEC/EN 61243-1)
- Part 412 "Resistive type to be used for voltages of 1 kV to 36 kV"
(IEC/EN 61243-2)
- Part 415 "Voltage detecting systems"
(IEC/EN 61243-5)
- Part 417 "Voltage detectors – Distance voltage detectors"
(preliminary standard DIN VDE V 0682-417/10.2013)
- Part 421 "Voltage detectors – Capacitive type to be used for a.c.
systems of 15 kV and 110 kV with a frequency of 16.7 Hz"
(VDE V 0682-421)
- Part 431 Part 1: Live working – Phase comparators – Capacitive type to
be used for voltages exceeding 1 kV a.c.
(IEC/EN 61481-1)
- Part 431 Part 2: Live working – Phase comparators – Resistive type to
be used for voltages from 1 kV to 36 kV a.c.
(IEC/EN 61481-2)
- Part 511 "Electrical insulating blankets"
(IEC/EN 61112)
- Part 512 "Electrical insulating matting"
(IEC/EN 61111)
- Part 513 "Flexible conductor covers (line hoses) of insulating material"
(IEC/EN 61479)
- Part 551 "Rigid protective covers for live working on a.c. installations"
(IEC/EN 61229)
- Part 552 "Insulating protective barriers above 1 kV"
- Part 603 "Telescopic sticks and telescopic measuring sticks"
(IEC/EN 62193)
- Part 621 "Suction device for the cleaning of live parts with rated
voltages above 1 kV up to 36 kV"
- Part 651 "Saddles, stick clamps and their accessories"
(IEC/EN 61236)
- Part 741 "Insulating aerial devices for mounting on a chassis"
(IEC/EN 61057)

DIN VDE 0683

"Live working"

- Part 100 "Portable equipment for earthing or earthing and
short-circuiting"
(IEC/EN 61230)
- Part 200 "Earthing or earthing and short-circuiting equipment using
lances as a short-circuiting device – Lance earthing"
(IEC/EN 61219)

2. Abbreviations

2.1 Materials

Abbreviation	Material
Al	Aluminium
AlMgSi	Aluminium alloy
Cu	Electric copper, copper
Ms	Brass
StSt	Stainless steel
St	Steel
MCI	Malleable cast iron
ZDC	Zinc die casting
GRP	Glass-fibre reinforced plastic
PP	Polypropylene

3. Minimum lengths of insulating elements for

- 1) Operating sticks acc. to DIN VDE 0681
- 2) Voltage detectors acc. to IEC/EN 61243-1 (DIN VDE 0682-411)
- 3) Phase comparators acc. to IEC/EN 61481 (DIN VDE 0682-431)

Nominal voltage	Rated voltage	Minimum length of the insulating element $L_{I \min}$		
		1)	2)	3)
U_N *)	U_r			
up to 10 kV	12 kV	500 mm	520 mm	525 mm
20 kV	24 kV	500 mm	520 mm	525 mm
30 kV	36 kV	525 mm	520 mm	525 mm
45 kV	52 kV	720 mm	830 mm	—
60 kV	72.5 kV	900 mm	830 mm	—
110 kV	123 kV	1300 mm	1300 mm	—
150 kV	170 kV	1750 mm	1700 mm	—
220 kV	245 kV	2400 mm	2300 mm	—
380 kV	420 kV	3200 mm	3600 mm	—

*) For nominal voltages higher or lower than the nominal voltage indicated in the table above, a rated voltage closest to the required nominal voltage must be selected. In extreme cases, the nominal voltage is equal to the rated voltage.











2.2 Coating materials

Abbreviation	Coating material
gal Sn	Tin-plated
gal Zn	Galvanised
tZn	Hot-dip galvanised
Bronze gal Sn	Bronze, tin-plated

2.3 Types of conductors

Abbreviation	Type of conductor
Fl	Flat conductor
Rd	Round conductor

4. Explanation of symbols

Symbol	Application
	Installation instructions, see www.dehn-international.com
	Not for use in wet weather conditions For indoor and outdoor installations For use in indoor and outdoor installations, but not in wet weather conditions.
	For use in wet weather conditions For indoor and outdoor installations For use in indoor and outdoor installations, in all weather conditions (even if the operating stick gets wet).
	For indoor installations only!
	Switchgear installations
	Overhead lines
	Components for railway applications
	New products
	Discontinued products
	see www.dehn-international.com Products / Selection guides and configurators / EaS configurator

5. Maintenance tests



Maintenance test criteria for protective and auxiliary equipment			
	DGUV regulation 3 (former BGV A3)	VDE 0105-100	Equipment standard
Earthing and short-circuiting devices	§ 5 (1) [... It shall be checked whether equipment is in good order and condition...] (2) [... at certain intervals. The intervals must be chosen so that the defects to be expected are detected in due time.]	5.3.101 [Periodic inspections, general information.]	IEC/EN 61230, Annex C (informative), C 3.2.2 [It is recommended to perform a cut test and visual inspection at least every five years in case of outdoor use and every ten years in case of indoor use.]
Voltage detectors, phase comparators and voltage detecting systems	§ 5: according to table 1C [Tests for compliance with the limit values specified in the electrotechnical rules must be carried out at least every six years.]	6.2.4 [Inspection at least before and, if possible, after each use], 5.3.101 [Periodic inspections, general information.]	IEC/EN 61243-1, Annex G (informative): Tests for capacitive voltage detectors > 1 kV [Voltage detectors that have not been subjected to a maintenance test within six years should not be used.] IEC/EN 61243-5: Tests for voltage detecting systems (VDS) IEC/EN 61481, Annex G (informative): Tests for phase comparators between 1 and 36 kV a.c. [The maximum interval between maintenance tests is six years.]
Operating and earthing sticks	§ 5: according to table 1C [A visual inspection for signs of damage and defects must be carried out prior to each use.]	5.3.101 [Periodic inspections, general information.]	VDE 0681-1 to 3: Tests for operating sticks Note: Operating sticks also have to be subjected to electrotechnical tests. DEHN recommends to use the test intervals of voltage detectors. E DIN VDE V 0681-1 to 3 Annex B (informative) [Maximum interval between maintenance tests for operating sticks is six years.]

6. Additional product information

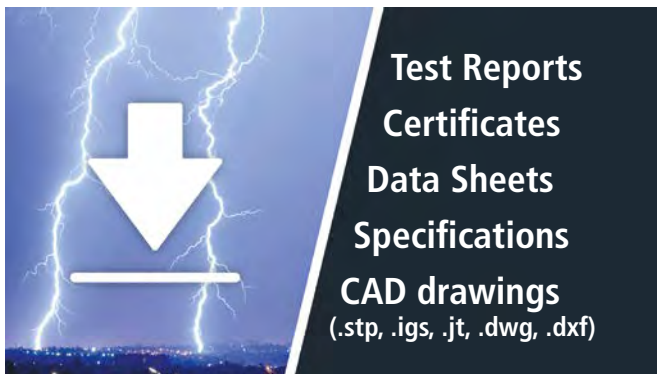
**Product documentation / construction and CAD drawings**

Planning, design and implementation drawings of lightning and surge protection systems require a detailed product documentation. Computer Aided Engineering (CAE) is based on construction and CAD drawings.

DEHN provides you with the following documents and drawings for collective download:

- Installation instructions / instructions for use
- Test reports
- Certificates
- Data sheets
- Specifications
- CAD drawings (file formats: .stp, .igs, .jt, .dwg, .dxf)

Supported product ranges:

- **Surge Protection Red/Line and Yellow/Line** (complete)
- **Lightning Protection / Earthing** (partly; other in preparation)
- **Safety Equipment** (partly; other in preparation)

Proceed as follows:

1. Registration under <https://www.dehn-international.com/user/register> or
2. Login under <https://www.dehn-international.com/user>
3. Selected products into the shopping cart
4. Collective download of all components in the shopping cart

Collective download of certificates and test reports

Collective download of certificates and test reports from the notepad of our website is immediately possible. Procedure is the same as with the collective downloads of data sheets etc.

Please note:

A certificate and/or test report is not available for all products.

Data sheets, test reports, 3D data and more also on the internet:
<http://de.hn/depd>

When working in and on electrical installations, the following five safety rules must be observed to prevent electrical accidents:



Five safety rules:

1. Disconnect completely

The electrical installation must be disconnected from live parts on all poles.

2. Secure against re-connection

Re-connection must be reliably prevented to ensure that an installation where work is in progress is not accidentally re-connected. This is achieved, for example, by replacing the unscrewed fuses in low-voltage installations by lockable lock-out devices.

3. Verify that the installation is dead

Suitable measuring / test equipment such as voltage detectors must be used to verify on all poles that the installation is dead.

4. Carry out earthing and short-circuiting



After verifying that the installation is dead, the cables and the earthing system are connected to short-circuit-proof earthing and short-circuiting devices. It must be observed that the relevant parts must be earthed before they are short-circuited.

5. Provide protection against adjacent live parts

According to the five safety rules, adjacent parts are parts located in the vicinity zone. If parts of an electrical installation in the vicinity of the work location cannot be disconnected, additional precautions must be taken before work starts as is the case with work in the vicinity of live parts.

Work according to the Five Safety Rules

1. Disconnect completely – Operating Sticks, Inspection Camera

Product	Type	Nominal voltage U_N / Frequency f_N	Application	Page
IS Insulating Sticks				
	IS Insulating Sticks	up to 123 kV / 50 Hz	For use in indoor and outdoor installations Screw-on switching stick head allows for use as switching stick Supporting head for hexagon shaft or T pin shaft For use as earthing stick For use as operating stick for insulating protective shutters	10
SCS Switching Sticks				
	SCS Switching Sticks	up to 123 kV / 50 Hz	For indoor and outdoor installations Fully insulated, massive switching stick head Allows a deep and safe reach into the installation For use as operating stick for insulating protective shutters	13
RST Rescue Rods				
	RST Rescue Rods	up to 36 kV / 50 Hz	For use in indoor and outdoor installations Fully insulated and fixed rescue hook For rescuing persons from the live working zone in the event of an electrical accident	14
SZ Fuse Tongs				
	SZ Fuse Tongs	up to 36 kV / 50 Hz	Operating head with two adjustable jaws Straight or 20° angled operating head Secure clamping Wide clamping range from Ø30 to 90 mm	14
Wireless Inspection Camera				
	Wireless Inspection Camera	up to 123 kV / 15 ... 60 Hz	Periodic visual inspection and documentation of electrical installations and equipment (also without special training) Wireless WiFi camera operation via smartphone/tablet No downtimes due to disconnection of the installation	16
Ice Removal Rod				
	Ice Removal Rod	up to 15 kV / 16.5 Hz and 25 kV / 50 Hz	For removing icicles in the vicinity of live parts Massive icicle removal hammer With telescopic handle	18
Insulating Stick with Crank Handle				
	Insulating Stick	up to 36 kV	For emergency operating of engine drives For indoor and outdoor installations	19
Insulating Stick Kit for Cleaning the Windscreens of E-Locomotives				
	Insulating Stick Kit	up to 7.5 kV / d.c. and 25 kV / a.c.	Insulating stick kit for cleaning the windscreens of electric locomotives	20
Storage Bags and Transport Cases				
		Cases: Sheet steel or plastic Bags: Artificial leather or canvas		158
Maintenance Tests according to German regulations DGUV Vorschrift 3 (former BGV A3)				
		According to German regulations DGUV Vorschrift 3 (former BGV A3), operating sticks have to be tested for compliance with the prescribed limits as stated in the Electrical Safety Rules. This test is performed in the high-voltage test laboratory of DEHN and includes – measurement of the leakage current, – test for protection against bridging, – visual inspection, manual tests and measurements. This maintenance test is documented in a test report and on the device. Prior to each use, operating sticks must be visually inspected for signs of damage or any other defect.		145

1. Disconnect completely – Operating Sticks, Inspection Camera

IS Insulating Sticks



Switching a disconnector by means of an IS SK insulating stick fitted with switching stick head.

Nominal voltages up to 123 kV / 50 Hz

Easy and safe working

- Cost-effective since the application of different supporting heads allows universal use
- Easy handling

General Information:	
Standard (switching stick head)	DIN VDE V 0681-2
Standard (insulating stick)	DIN VDE V 0681-1
Standard (operating stick)	DIN VDE 0682-552
Not for use in wet weather conditions	☀
For use in wet weather conditions	☁
For	Indoor and outdoor installations
Material	Glass-fibre reinforced polyester tube



IS SK insulating stick fitted with SSK M12 switching stick head.



IS SQ insulating stick fitted with SSK SQ switching stick head. Black knurled nut for additional locking on the insulating stick.

Insulating Stick, Hexagon Shaft

Operating head with spring locking mechanism and M12 threaded bushing

- Can be used as switching and operating stick by attaching a SSK M12 switching stick head
- Can be used as earthing stick
- Handle closed with end cap

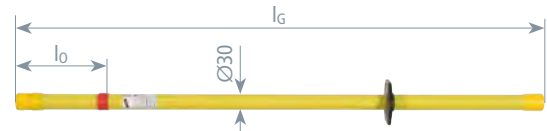

Type	IS 36 SK 1000	IS 36 SK 1500
Part No.	766 001	766 002
Nominal voltage (UN)	1 ... 36 kV	1 ... 36 kV
Total length (lG)	1000 mm	1500 mm
Insertion depth (l0)	175 mm	475 mm
For use at	☀	☀



Insulating Stick, T Pin Shaft

Operating head with spring-loaded bayonet coupling

- Can be used as switching and operating stick by attaching a SSK SQ switching stick head
- Can be used as operating stick for inserting insulating protective shutters
- Can be used as earthing stick
- Handle closed with end cap

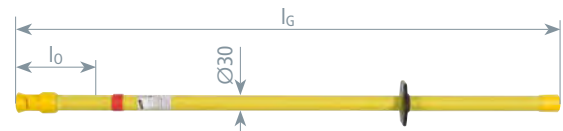

Type	IS 36 SQ 1000	IS 36 SQ 1500	IS 72.5 SQ SN7743
Part No.	766 311	766 315	766 312
Nominal voltage (UN)	1 ... 36 kV	1 ... 36 kV	1 ... 72.5 kV
Max. load on the operating head *)	17 kg	17 kg	—
Total length (lG)	1025 mm	1525 mm	1300 mm
Insertion depth (l0)	150 mm	500 mm	90 mm
For use at	☀	☀	☀



*) Max. shutter weight when inserting insulating protective shutters

1. Disconnect completely – Operating Sticks, Inspection Camera

Insulating Stick, Hexagon Shaft, Plug-in Coupling

Operating head with spring locking mechanism and M12 threaded bushing

- Can be used as switching and operating stick by attaching a SSK M12 switching stick head
- Can be used as earthing stick
- Handle closed with plastic plug-in coupling for extending the handle



Type	IS 36 SK STK 1000	IS 123 SK STK 2000	ISN 36 SK STK 1000
Part No.	766 100	766 122	766 111
Nominal voltage (U _N)	1 ... 36 kV	1 ... 123 kV	1 ... 36 kV
Total length (l _G)	1000 mm	2000 mm	1000 mm
Insertion depth (l _o)	175 mm	200 mm	175 mm
For use at			

Insulating Stick, T Pin Shaft, Plug-in Coupling

Operating head with spring-loaded bayonet coupling

- Can be used as switching and operating stick by attaching a SSK SQ switching stick head
- Can be used as operating stick for inserting insulating protective shutters
- Can be used as earthing stick
- Handle closed with plastic plug-in coupling for extending the handle

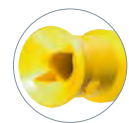
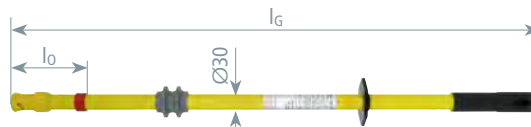

Type	IS 36 SQ STK 1000	IS 123 SQ STK 2000	ISN 36 SQ STK 1000
Part No.	766 301	766 322	766 310
Nominal voltage (U _N)	1 ... 36 kV	1 ... 123 kV	1 ... 36 kV
Max. load on the operating head *)	17 kg	8 kg	17 kg
Total length (l _G)	1025 mm	2000 mm	1025 mm
Insertion depth (l _o)	150 mm	200 mm	150 mm
For use at			

*) Max. shutter weight when inserting insulating protective shutters

Insulating Stick, detachable, T Pin Shaft, Plug-in Coupling

Operating head with bayonet coupling with spring locking mechanism

- Can be used as switching stick and operating stick by attaching the switching stick head SSK SQ
- Can be used as operating stick for inserting insulating protective shutters
- Can be used as earthing stick
- Can be used as handle termination with end cap

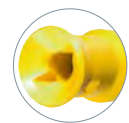
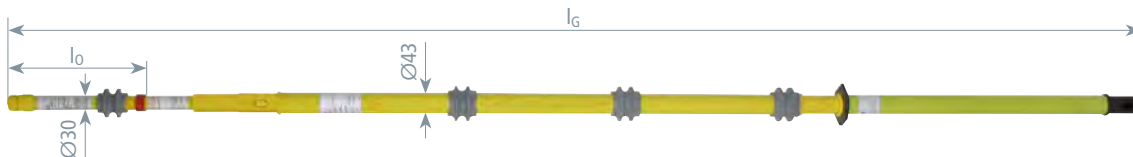

Type	ISN 123 SQ STK 2500
Part No.	766 332
Nominal voltage (U _N)	110 ... 123 kV
Max. load on the operating head *)	15 kg
Total length (l _G)	2495 mm
Insertion depth (l _o)	290 mm
For use at	

*) Max. weight of insulating shutters, for example.

Accessories for IS Insulating Sticks

Screw-on switching stick head for IS SK insulating sticks

With M12 thread.

In accordance with DIN VDE V 0681-2.

Type	SSK M12
Part No.	765 005
Material	Steel, plastic-sheathed



Switching stick head for IS SQ insulating sticks

With T pin shaft (bayonet locking mechanism).

In accordance with DIN VDE V 0681-2.

T pin shaft in accordance with DIN 48087.

Switching stick head is fixed on the insulating stick via the knurled nut.

Type	SSK SQ
Part No.	765 009
Material	Polyamide



1. Disconnect completely – Operating Sticks, Inspection Camera

Insulating Stick, Plug-in Coupling at both ends

Plug-in coupling at both ends for attaching extension elements, operating heads or adapters.

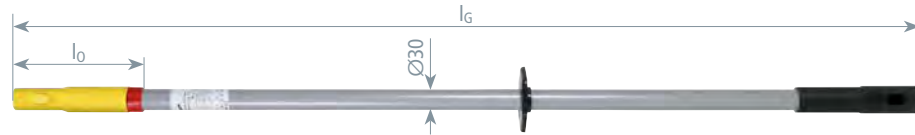

Type	IS 36 STK 30 1280	ISN 36 STK 30 1280	ISN 36 STK 930SN7688
Part No.	766 363	766 367	766 362
Nominal voltage (U _N)	1 ... 36 kV	1 ... 36 kV	1 ... 36 kV
Total length (l _G)	1280 mm	1280 mm	930 mm
For use at			

Accessories for IS Insulating Sticks

STK Switching stick head



Type	SSK 36 STK 560
Part No.	766 164
Total length (l _G)	560 mm

STK Operating head / hexagon shaft

Operating head with tension spring locking and M12 threaded bushing for indoor use.

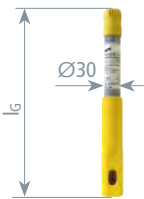

Type	AK 36 SK STK 330
Part No.	766 364
Total length (l _G)	330 mm

STK Operating head / T pin shaft

Operating head with spring-loaded bayonet coupling for indoor use.

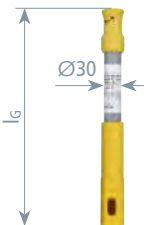

Type	AK 36 SQ STK 360
Part No.	766 365
Total length (l _G)	360 mm

1. Disconnect completely – Operating Sticks, Inspection Camera

SCS Switching Sticks

Nominal voltages up to 72.5 kV / 50 Hz

Easy and safe working

- Cost-effective
- User-friendly



Switching a disconnector by means of an SCS switching stick

General Information:	
Standard (switching stick head)	DIN VDE V 0681-2
Standard (switching stick)	DIN VDE V 0681-1 and -2
Standard (insulating stick)	DIN VDE V 0681-1
Standard (operating stick)	DIN VDE 0682-552
Not for use in wet weather conditions	☀
For use in wet weather conditions	☔
For	For indoor and outdoor installations
Design	Fully insulated, massive switching stick head
Material (insulating tube)	Glass-fibre reinforced polyester tube
Material (switching pin)	Steel, plastic-sheathed

Nominal Voltages up to 72.5 kV

With end cap.

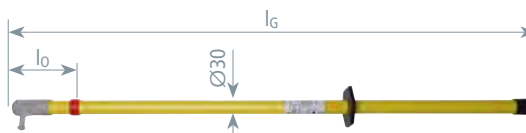

General Information:	
For use at	☀

Type	SCS 36 1000	SCS 36 1500	SCS 36 2000
Part No.	763 610	763 611	763 612
Nominal voltage (UN)	1 ... 36 kV	1 ... 36 kV	1 ... 36 kV
Max. load on the operating head	6 kg	7.5 kg	7.5 kg
Total length (lG)	1030 mm	1500 mm	2000 mm
Insertion depth (l0)	135 mm	415 mm	765 mm

Type	SCS 72 1500	SCS 72 2000
Part No.	763 615	763 620
Nominal voltage (UN)	1 ... 72.5 kV	1 ... 72.5 kV
Max. load on the operating head	—	—
Total length (lG)	1500 mm	2000 mm
Insertion depth (l0)	290 mm	690 mm

Nominal Voltages up to 36 kV

Handle sealed with plastic plug-in coupling for extending the handle.

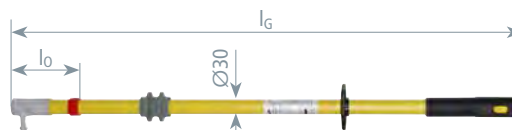

Type	SCS 36 STK 1000	SCSN 36 STK 1000
Part No.	763 100	763 111
Nominal voltage (UN)	1 ... 36 kV	1 ... 36 kV
Max. load on the operating head	6 kg	6 kg
Total length (lG)	1000 mm	1000 mm
Insertion depth (l0)	135 mm	135 mm
For use at	☀	☔

1. Disconnect completely – Operating Sticks, Inspection Camera

RST Rescue Rods

Operating Sticks,
1. Inspection Camera



Insulated RST rescue rod used to rescue a victim of electrical shock from the live working zone

Nominal voltages up to 36 kV / 50 Hz

- For use in indoor and outdoor installations
- Fixed rescue hook (protected against bridging)
- For rescuing persons weighing up to approximately 100 kg from the live working zone in the event of an electrical accident



General Information:

Standard	based on DIN VDE V 0681-1
Not for use in wet weather conditions	
Material (hook)	PVC-HI solid rod
Material (insulating tube)	Glass-fibre reinforced polyester tube
End fitting	Non-slip plastic cap

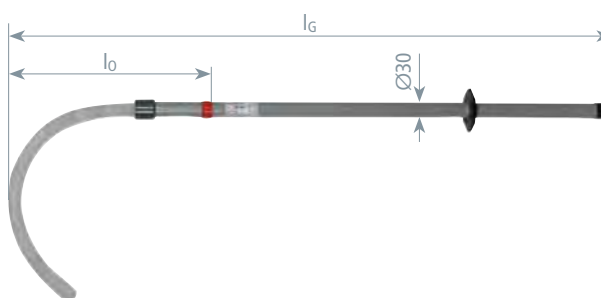

Rescue Rod up to 36 kV

Type RST 36 ...	1000	1500	2000
Part No.	766 040	766 041	766 042
Nominal voltage (UN)	1 ... 36 kV	1 ... 36 kV	1 ... 36 kV
Total length (lG)	1235 mm	1695 mm	2195 mm
Insertion depth (l0)	410 mm	620 mm	970 mm

SZ Fuse Tongs

Nominal voltages up to 36 kV / 50 Hz

Easy and safe working

- User-friendly



General Information:

Standard	DIN VDE V 0681-3
Not for use in wet weather conditions	
Design	Straight and 20° angled clamp body
Clamping range	Wide clamping range from Ø30 to 90 mm
Material (insulating stick)	Glass-fibre reinforced polyester tube
Material (operating head)	Glass-fibre reinforced polyamide
Material (adjustable handle)	Polyamide
Material (reducing insert)	Polyamide
Colour	Grey ●



SZ fuse tongs for inserting and removing HH fuses



The reducing insert delivered with the SZ fuse tong allows low clamping ranges from Ø30 to 50 mm. Without reducing insert, HV HBC fuses from Ø50 to 90 mm can be actuated.



In practice, the 20° angled operating head allows safe and easy actuation of HH fuses that are not easily accessible.

1. Disconnect completely – Operating Sticks, Inspection Camera

Straight version

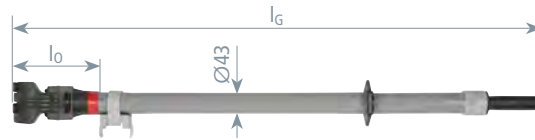

Type SZ HH ...	1060	1250	1500
Part No.	765 040	765 041	765 042
Nominal voltage (U _N)	1 ... 36 kV	1 ... 36 kV	1 ... 36 kV
Clamping range	30 ... 50 ^{*)} / 50 ... 90 mm	30 ... 50 ^{*)} / 50 ... 90 mm	30 ... 50 ^{*)} / 50 ... 90 mm
Total length (l _G)	1060 mm	1250 mm	1500 mm
Insertion depth (l _o)	185 mm	185 mm	185 mm

^{*)} Only if used with reducing insert

20° angled version

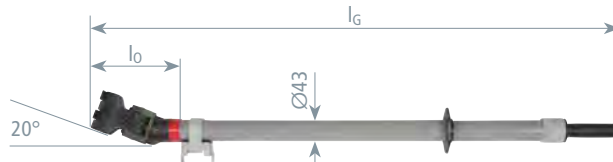

Type SZ HH ...	W20 1070	W20 1250	W20 1500
Part No.	765 050	765 051	765 052
Nominal voltage (U _N)	1 ... 36 kV	1 ... 36 kV	1 ... 36 kV
Clamping range	30 ... 50 ^{*)} / 50 ... 90 mm	30 ... 50 ^{*)} / 50 ... 90 mm	30 ... 50 ^{*)} / 50 ... 90 mm
Total length (l _G)	1070 mm	1250 mm	1500 mm
Insertion depth (l _o)	195 mm	195 mm	195 mm

^{*)} Only if used with reducing insert

Accessories for SZ Fuse Tong

Storage device for HH fuses

Wall-mounted.

Type	HV 3HH ET
Part No.	700 005
For	HH fuses

Note: Two storage devices are required!



Storage device for HH fuses and fuse tong

Wall-mounted.

Type	HV 3HH SZ ET
Part No.	700 004
For	HH fuses and fuse tong

Note: Two storage devices are required!



Storage device kit for HH fuses or HH fuses and fuse tong

Wall-mounted.

Type	HV 3HH	HV 3HH SZ
Part No.	700 015	700 014
Consisting of	2x HV 3HH ET	1x HV 3HH ET and 1x HV 3HH ZS ET



1. Disconnect completely – Operating Sticks, Inspection Camera

Wireless Inspection Camera



Live inspection of an insulator on its rear side.

Nominal voltages up to 123 kV / 15 ... 60 Hz

- Wireless inspection camera for periodic visual inspection and for documenting the state of electrical installations and equipment (also without special training)
- Brings the invisible to light
- Facilitates work
- Increases safety
- Saves time

General Information:	
Standard	based on EN 50508 (DIN VDE 0682-213)
Temperature range (TU)	0 °C ... +40 °C
Not for use in wet weather conditions	☀
Material (enclosure)	PUR
Material (camera)	Plastic



Digital Camera Kit



Kit includes:		
Item	Description	Type
1	Plastic case	KKL DIGIK
2	Digital camera enclosure	G DIGIK L
3	Gear coupling adapter	AD M6 ZK 185
4	Digital camera	DIGIK QX10

Type	SET DIGIK
Part No.	766 390
Nominal voltage (U _N)	up to 123 kV
Frequency	15-60 Hz
Resolution	18.2 megapixel
Objective	wide-angle lens (10x optical zoom)
Image stabiliser	optical image stabiliser
Focus	autofocus
Equipment	PlayMemories Mobile App, Wi-Fi integrated
Interfaces	micro-USB (USB 2.0) port
Dimensions (case)	395 x 290 x 105 mm

*) Handle and insulating rod are not included.

LED Lighting

LED lighting to be attached to the D DIGIK L enclosure of the digital camera for visual inspection and documenting the state electrical installations up to 123 kV, also in case of poor lighting conditions.

NEW

Type	LED DIGIK ISO
Part No.	766 395 ^{NEW}
Nominal voltage (U _N)	up to 123 kV
Lamp	mini LED torch
Luminous flux	37 lumen

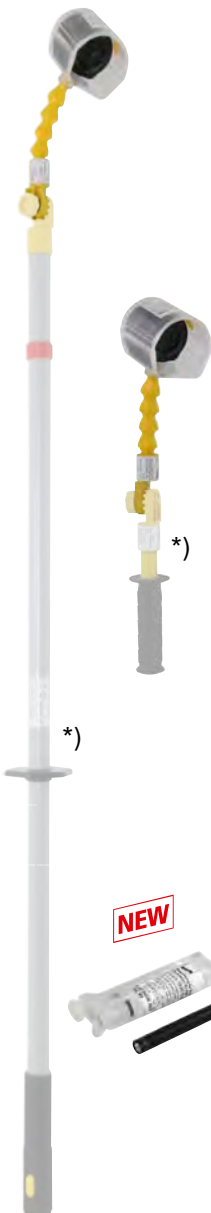











1. Disconnect completely – **Operating Sticks, Inspection Camera**

Recommended Accessories for Wireless Inspection Camera





Nominal voltages up to 1000 V / 15 ... 60 Hz and 1500 V / DC

Device	Description	Type	Part No.
	Handle with Gear Coupling	HG ZK 230	766 393

Nominal voltages up to 36 kV / 15 ... 60 Hz

Device	Description	Type	Part No.
	Insulating stick with handle and plug-in coupling, 1300 mm	IS 36 ZK STK 1300	785 325
	Insulating stick, detachable, with handle and plug-in coupling, 1300 mm	IS T 36 ZK STK 1300	785 315
	Insulating stick IS STK, plug-in coupling at both ends, 30 mm, 1280 mm	IS 36 STK 30 1280	766 363
	Adapter with gear coupling, 360 mm	AD ZK STK 30 360	766 359
	Insulating stick (T pin shaft), 1025 mm	IS 36 SQ 1000	766 311
	Insulating stick (T pin shaft), 1525 mm	IS 36 SQ 1500	766 315
	Insulating stick (T pin shaft) and plug-in coupling, 1025 mm	IS 36 SQ STK 1000	766 301
	Adapter (T pin shaft) / gear coupling, 182 mm	AD SQ ZK 165	766 396
	Extension with gear coupling, 220 mm	ISV 220 ZK MS	785 316
	Extension with gear coupling, 320 mm	ISV 320 ZK MS	785 317
	Extension with gear coupling, 420 mm	ISV 420 ZK MS	785 318
	Extension with gear coupling, 820 mm	ISV 820 ZK MS	785 319
	Insulating stick extension ISV 36 STK, plug-in coupling at both ends, 30 mm, 910 mm	ISV 36 STK 30 910	766 356
	Insulating stick extension ISV 36 STK, plug-in coupling at both ends, 30 mm, 1280 mm	ISV 36 STK 30 1280	766 366
	Handle extension HV STK, plug-in coupling at both ends, 30 mm, 710 mm	HV STK 30 710	766 335
	Handle extension HV STK, plug-in coupling at both ends, 43 mm, 910 mm	HV STK 43 910	766 456
	Handle extension HV STK, plug-in coupling at both ends, 43 mm, 1280 mm	HV STK 43 1280	766 466

Nominal voltages up to 123 kV / 15 ... 60 Hz

Device	Description	Type	Part No.
	Insulating stick (T pin shaft), plug-in coupling, 30 mm, 2000 mm	IS 123 SQ STK 2000	766 322
	Adapter (T pin shaft) / gear coupling, 182 mm	AD SQ ZK 165	766 396
	Extension with gear coupling, 220 mm	ISV 220 ZK 123 SN7739	785 311
	Extension with gear coupling, 320 mm	ISV 320 ZK 123 SN7740	785 312
	Extension with gear coupling, 420 mm	ISV 420 ZK 123 SN7741	785 313
	Extension with gear coupling, 820 mm	ISV 820 ZK 123 SN7742	785 314
	Handle extension HV STK, plug-in coupling at both ends, 30 mm, 710 mm	HV STK 30 710	766 335
	Handle extension HV STK, plug-in coupling at both ends, 43 mm, 910 mm	HV STK 43 910	766 456
	Handle extension HV STK, plug-in coupling at both ends, 43 mm, 1280 mm	HV STK 43 1280	766 466

1. Disconnect completely – Operating Sticks, Inspection Camera

Ice Removal Rod

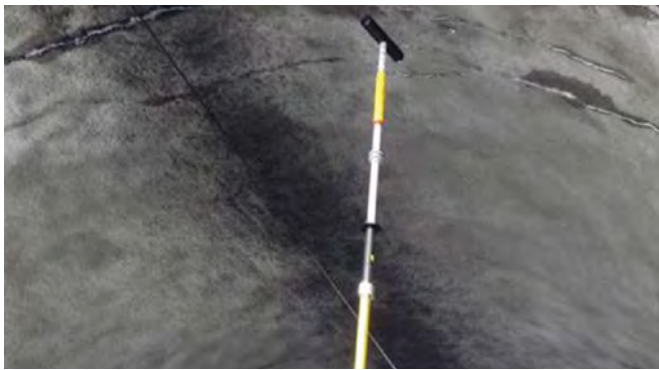

Removing icicles on a tunnel entrance.



Nominal voltages up to 25 kV

- For removing icicles in the vicinity of live parts e.g. outdoor overhead contact lines or tunnel systems
- Massive icicle removal hammer made of insulating material
- Insulating stick for 15 kV / 16.7 Hz and 25 kV / 50 Hz systems
- With telescopic handle up to a total length of 3420 mm to 5270 mm

General Information:	
Standard (operating head)	Based on DIN VDE 0682-411 and DIN VDE V 0681-1
Standard (insulating stick)	Based on DIN VDE 0682-411 and DIN VDE V 0681-1
For use in wet weather conditions	
Material (insulating stick)	Glass-fibre reinforced polyester tube
Material (handle)	Glass-fibre reinforced polyester tube

Operating Head (Hammer)

With plug-in coupling.

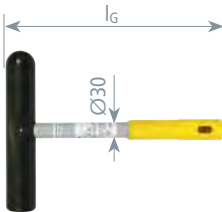

Type	AK 25 ESH STK SN7361
Part No.	766 372
Nominal voltage (U _N)	1 ... 25 kV
Total length (l _G)	400 mm
Dimensions (operating head)	300 x 56 mm
For use at	

Insulating Stick

With plug-in coupling for operating head (hammer).

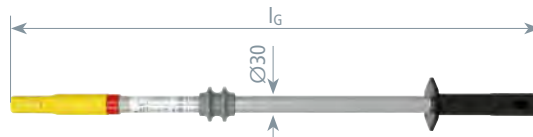

Type	ISN 25 STK 900SN7360
Part No.	766 371
Nominal voltage (U _N)	1 ... 25 kV
Total length (l _G)	920 mm
For use at	

Telescopic Extension Handle

With plug-in coupling for the insulating stick and end fitting with eye.

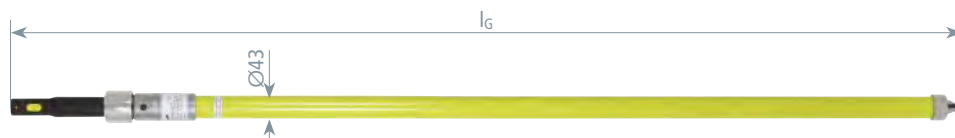

Type	HVTC STK 4100 SN7359
Part No.	766 469
Total length (l _{G max} / l _{G min})	4120 / 2290 mm
For use at	

1. Disconnect completely – Operating Sticks, Inspection Camera

Insulating Stick with Crank Handle

Nominal voltages up to 36 kV / 15 ... 60 Hz

- For emergency operating of engine drives
- For indoor and outdoor installations



General Information:	
Standard	DIN VDE V 0681-1
Not for use in wet weather conditions	☀
Material (operating head)	Plastic
Material (extension)	Glass-fibre reinforced polyester tube
Material (test unit)	Glass-fibre reinforced polyester tube



Operating Head

With hexagon shaft 24 mm and hexagon coupling 12 mm.

Type	AK SK24 SK12
Part No.	763 712
Total length (l _G)	120 mm
Diameter	30 mm
For use at	☀

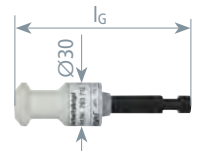

Insulating Stick with Crank Handle

With hexagon coupling 12 mm and button.

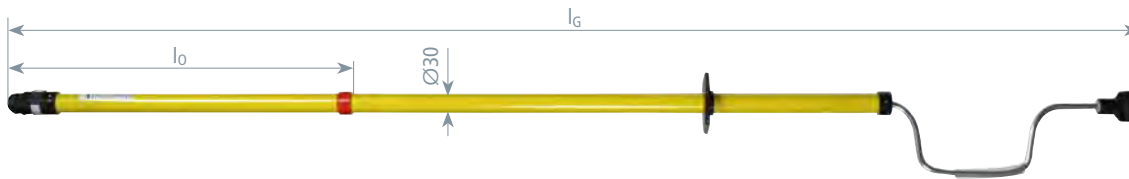

Type	IS SK12 HK 1720
Part No.	763 710
Nominal voltage (U _N)	1 ... 36 kV
Total length (l _G)	1720 mm
Insertion depth (l _o)	540 mm
Diameter	30 mm
For use at	☀

Insulating Stick Extension

With hexagon coupling 12 mm and button.



Type	ISV SK12 1060
Part No.	763 711
Nominal voltage (U _N)	1 ... 36 kV
Total length (l _G)	1060 mm
Diameter	30 mm
For use at	☀

1. Disconnect completely – Operating Sticks, Inspection Camera

Insulating Stick Kit for Cleaning the Windscreens of Electric Locomotives



Insulating stick kit used for cleaning the windscreen of an electric locomotive

- Nominal voltages up to 7.5 kV / d.c. and 25 kV / a.c.
- For cleaning the windscreens of electric locomotives
 - Protection against accidental contact with live parts (e.g. overhead contact lines)
 - Adjustable inclination angle of the operating head

General Information:	
Standard	Wet test in accordance with EN/IEC 61243-1 (DIN VDE 0682-411)
For use in wet weather conditions	
Material (insulating tube)	Glass-fibre reinforced polyester tube
End fitting	Non-slip plastic cap



Adapter with gear coupling for attaching the cleaning head.



The hook-and-loop fastener allows fast replacement of the cleaning pad.



The universal gear coupling can be adjusted from 0° to 90° in 30° increments.

Note:
In accordance with EN/IEC 61243-1 (DIN VDE 0682-411), IS 25 ZK 2885 insulating sticks and AD ZK 25 200 adapters can also be used in wet weather conditions for nominal voltages up to 7.5 kV d.c. and 25 kV a.c. The cleaning agent must not exceed the maximum conductivity of 1000 µS / cm. Due to the risk of bridging, water and cleaning agents must not be used to clean live parts of installations.

Insulating Stick Kit for Cleaning Windscreens

Parts list:			
Pos.	Part No.	Pos.	Part No.
1	766 048	3	766 056
2	766 055	4	766 057

For more detailed information on these products, see Accessories chapter

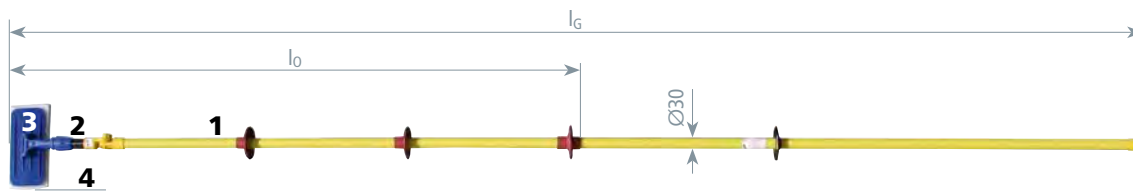

Type	IS 25 ZK RK 3160
Part No.	766 340
Nominal voltage U_N a.c.	Up to 25 kV
Nominal voltage U_N d.c.	Up to 7.5 kV
Total length (l_G)	3160 mm
Insertion depth (l_0)	1630 mm

Lock-out Systems

Nominal voltages up to 1000 V

- Protection against re-connection
- Symbol "No switch"
[Do not close the circuit] acc. to German regulations (VGB 125)



General Information:

Only for indoor installations



For

Indoor installations



Lock-out system for three modular widths.

Insulating Plug

For screw inserts.

Type SE ...	E14	E18	E27 E33
Part No.	785 639	785 650	785 640
Size	E14	E18	E27 and E33
Diameter	20 mm	25 mm	45 mm
Dimensions	Ø20 x 40 mm	Ø25 x 40 mm	Ø45 x 55 mm
PU	10 pc(s)	10 pc(s)	10 pc(s)



Insulating Blade

For NH fuse holders and distribution blocks.

Type SE ...	NH00	NH0	NH1	NH2 3
Part No.	785 641	785 642	785 643	785 644
Size	00	0	1	2 and 3
Blade	13 x 5 mm	38 x 5 mm	38 x 5 mm	38 x 5 mm
Dimensions	80 mm	125 mm	135 mm	150 mm
PU	10 pc(s)	10 pc(s)	10 pc(s)	10 pc(s)



Lock-out System

For single-pole and multipole circuit breakers with a clamping range of 45 mm.

Type SE ...	REG 1TE	REG 2TE	REG 3TE
Part No.	785 638	785 652	785 637
Size	1 modular width	2 modular widths	3 modular widths
Dimensions	52 x 17 mm	52 x 34 mm	52 x 51 mm
PU	10 pc(s)	10 pc(s)	10 pc(s)





DEHN protects.®



3. Verify that the Installation is dead – DEHNcheck Voltage Detectors

Product	Type	Nominal voltage U_N / Frequency f_N	Application, Indication	Page
PHE4 Voltage Detector				
	PHE4	up to 30 kV / 50 or 60 Hz up to 30 ... 420 kV / 50 Hz up to 33 kV / 50 Hz (British Influenced Voltage Level)	For use in wet weather conditions For indoor and outdoor installations Visual and acoustic indicator Self-test of all live parts (up to 36 kV) Wide nominal voltage range	25
PHE III Voltage Detector				
	PHE III	up to 30 kV / 50 Hz	For use in wet weather conditions For indoor and outdoor installations	29
	PHE III ZK Indicator with test prod	up to 30 kV / 50 Hz (with self-testing element)	With self-testing element Visual and acoustic indicator	31
	PHE III Kit	20 and 60 ... 110 kV / 50 Hz	Fast battery replacement without additional tools	32
PHE Voltage Detector				
	PHE	up to 20 kV / 50 Hz or 16.7 Hz up to 20 kV / 16.7 Hz	For use in wet weather conditions For indoor and outdoor installations	34
	PHE Kit	15 kV / 16.7 Hz	With self-testing element Visual indicator	36
PHG II Voltage Detector				
	PHG II	6 / 10 / 20 kV / 50 Hz	For indoor installations only LEDs staggered at 120° allow for better visibility of the indication Passive voltage detector without batteries	37
Non-Contact Voltage Detector				
	ASP	110 ... 420 kV / 50 Hz or 16.7 Hz	For use in wet weather conditions Non-contact voltage detector	38
	HSA	1 ... 420 kV / 50 Hz, 60 Hz or 16.7 Hz	For overhead lines and outdoor switching stations With self-testing element Visual and acoustic indicator	40
PHE/G d.c. Voltage Detector				
	PHE/G	up to 24 kV / d.c. voltage	For use in wet weather conditions For indoor and outdoor installations With self-testing element Visual indicator Two-pole unit (one stick / two sticks)	42
SPN Voltage Detector				
	SPN	50 ... 500 V 50 ... 1000 V	For use in wet weather conditions No batteries required Can also be used in overhead line networks by attaching extension prods	44
Storage Bags and Transport Cases				
	Cases: Sheet steel or plastic Bags: Artificial leather or canvas			158
Maintenance Tests according to German regulations DGUV Vorschrift 3 (former BGV A3)				
	<p>According to German regulations DGUV Vorschrift 3 (former BGV A3), voltage detectors have to be tested for compliance with the prescribed limits as stated in the Electrical Safety Rules. This test is performed in the high-voltage test laboratory of DEHN and includes</p> <ul style="list-style-type: none"> – measurement of the leakage current, – test for clear indication, – test for protection against bridging, – visual inspection, manual tests and measurements. <p>This maintenance test is documented in a test report and on the device. The test intervals depend on the operating conditions of the voltage detector, e.g. frequency of use, environmental conditions and transport. According to German regulations, however, it is advisable to carry out a maintenance test at least every 6 years.</p>			145

3. Verify that the Installation is dead – DEHNcheck Voltage Detectors

Design of Voltage Detectors

Voltage detectors according to IEC/EN 61243-1 (DIN VDE 0682-411) are designed to verify on all poles at the work location that the installation is dead according to EN 50110-1 (DIN VDE 0105-100).

Only electrotechnically skilled or instructed persons are allowed to verify on all poles at the work location or as close as possible to the work location that the installation is dead.

Voltage detectors must be tested for correct operation immediately before and after use. Correct operation of voltage detectors without self-testing element must be verified by contacting a part of the installation connected to operating voltage.

Verifying that the installation is dead using a voltage detector is considered live working.

Voltage detectors may only be used for the nominal voltages / nominal voltage ranges as indicated on the rating plate. The user may be at risk if the voltage detector is used for voltages other than indicated on the rating plate (incorrect indication, electric shock, arcing).

Voltage detectors labelled with "For indoor use only" may only be used in indoor installations.

Voltage detectors labelled with "For use in wet weather conditions" may be used in all weather conditions (rain, snow, fog and dew).

Voltage detectors according to IEC/EN 61243-1 (DIN VDE 0682-411) are only suitable to a limited extent for use in **factory assembled (type-tested) installations**. If space in installations is confined, flashover may occur when inserting the test prod into the installation. The user of the voltage detector or the operator of the switchgear installation must contact the manufacturer of the type-tested installation to find out whether the voltage detector may be used in the installation (please refer to the table on the next page: Application of voltage detectors in type-tested, factory assembled switchgear installations).

Design of voltage detectors

Voltage detectors according to IEC/EN 61243-1 (DIN VDE 0682-411) are **single-pole** devices designed to make contact with the part of the installation to be tested.

There are **two mechanically different designs** of voltage detectors: Complete and separate voltage detectors.

Complete voltage detectors (PHE4, PHE III, PHE and PHG II) consist of an insulating stick, indicator and test prod and are tested as a complete unit. **Separate** voltage detectors (PHE III indicator with test prod) must be attached to a suitably rated insulating stick.

Single-pole **voltage detectors** typically consist of a **handle, insulating element, indicator** and **test prod with contact electrode**.

The **insulating element** is the section of a voltage detector between the hand guard and the red ring. It ensures that the user maintains an adequate safety distance for safe operation.

The **test prod** (contact electrode extension) with a contact electrode **above the red ring** allows to reach remote parts of the installation and to **eliminate** the influence of **interference fields**.

Voltage detectors are classified into two categories based on their behaviour in case of interference fields or their field of application. Voltage detectors of **category "L"** (line) with a short test prod (without contact electrode extension) are designed for use on overhead lines.

Voltage detector of **category "S"** (switchgear) with a long test prod (with contact electrode extension) are resistant to interference fields and are therefore used in switchgear installations. They are also suitable for overhead lines.

The **hand guard** provides a visible barrier between the handle and the insulating element and prevents the user from making contact with the insulating element.

The **red ring** indicates the end of the insulating element in the direction of the test electrode. This provides the user with a visible limit for contact with live parts in the installation. The **insulating element** between the red ring and the hand guard must not contact live parts, however, it may contact earthed parts.

The **test electrode** is the part of the voltage detector that is used to make contact with the part of the installation to be tested.

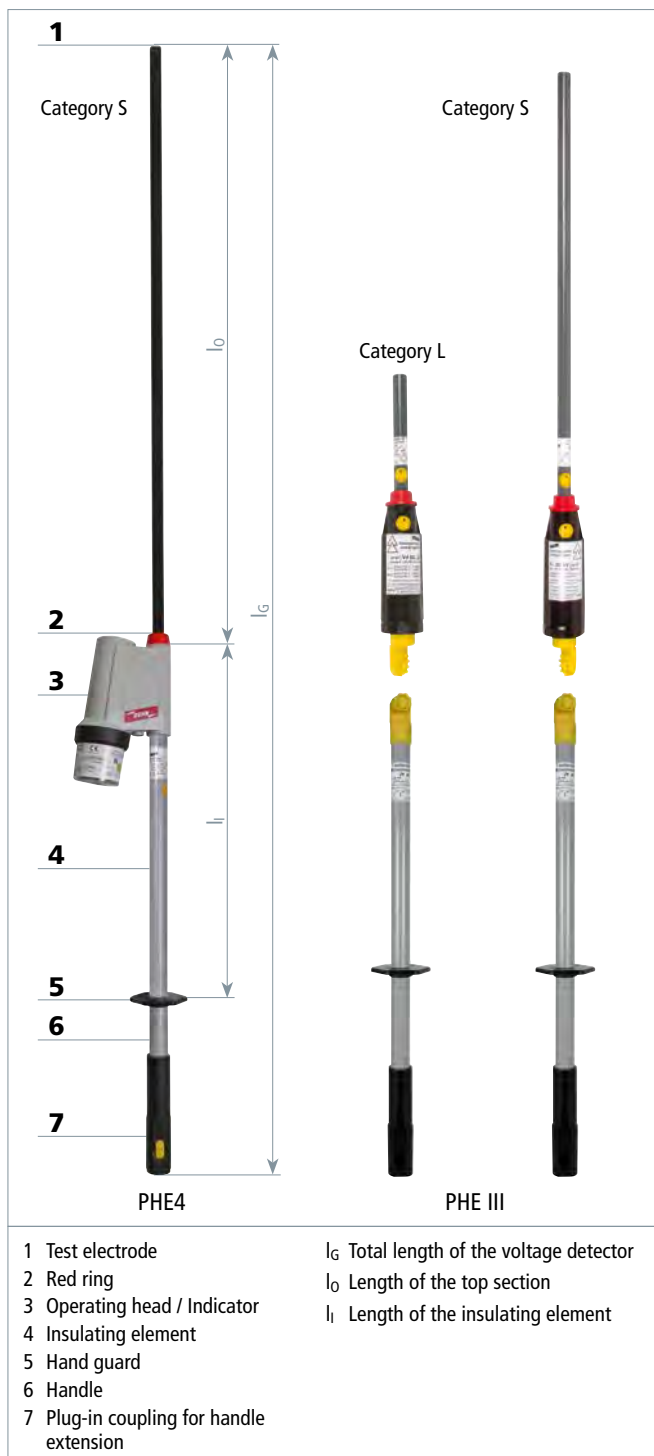

3. Verify that the Installation is dead – DEHNcheck Voltage Detectors

PHE4 Voltage Detector Nominal Voltage 1 ... 36 kV

- Self-test of all live parts including test prod
- Unique plug-in coupling system
- Integrated visual and acoustic indication
- Also for use in wet weather conditions

General Information:	
Standard	EN/IEC 61243-1 (DIN VDE 0682-411)
Temperature range	-25 °C ... +70 °C, climatic category N and W
Design	Complete
For use in wet weather conditions	
For	Indoor and outdoor installations
Indication	Acoustic and visual
Self-testing element	Yes
Material (test electrode)	Cu alloy/gal Sn
Material (test prod)	Glass-fibre reinforced epoxy resin tube
Material (indicator)	Plastic, fully insulated
Material (insulating stick)	Glass-fibre reinforced polyester tube



PHE4 voltage detector with visual and acoustic indication.

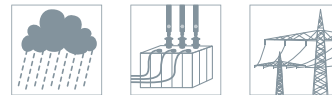

Nominal Voltages up to 30 kV / 50 Hz, M12 Thread

Category "S" for switchgear installations and overhead lines.



Type PHE4 ...	3 S	6 S	10 S
Part. No.	783 003	783 006	783 010
Nominal voltage (U _N)	3 kV	6 kV	10 kV
Total length (l _G)	1030 mm	1030 mm	1030 mm
Insertion depth (l _o)	230 mm	230 mm	230 mm

Type PHE4 ...	20 S	30 S
Part. No.	783 020	783 030
Nominal voltage (U _N)	20 kV	30 kV
Total length (l _G)	1200 mm	1720 mm
Insertion depth (l _o)	400 mm	920 mm

Nominal Voltages up to 36 kV / 50 Hz, M12 Thread

Category "S" for switchgear installations and overhead lines.

Type PHE4 ...	1 3 S	3 10 S	6 20 S
Part. No.	783 013	783 231	783 235
Nominal voltage (U _N)	1 ... 3 kV	3 ... 10 kV	6 ... 20 kV
Total length (l _G)	1410 mm	1410 mm	1600 mm
Insertion depth (l _o)	610 mm	610 mm	800 mm

Type PHE4 ...	10 20 S	10 30 S	20 36 S
Part. No.	783 240	783 250	783 245
Nominal voltage (U _N)	10 ... 20 kV	10 ... 30 kV	20 ... 36 kV
Total length (l _G)	1410 mm	1720 mm	1720 mm
Insertion depth (l _o)	610 mm	920 mm	920 mm

Nominal Voltages up to 36 kV / 50 Hz, switchable, M12 Thread

Category "S" for switchgear installations and overhead lines.

Type PHE4 ...	U 2 20 S	U 3 30 S	U 6 36 S
Part. No.	783 520	783 530	783 536
Nominal voltage (U _N)	2 ... 6 / 6 ... 20 kV	3 ... 10 / 10 ... 30 kV	6 ... 15 / 15 ... 36 kV
Total length (l _G)	1600 mm	1720 mm	1720 mm
Insertion depth (l _o)	800 mm	920 mm	920 mm

3. Verify that the Installation is dead – DEHNcheck Voltage Detectors



Nominal Voltages up to 30 kV / 50 Hz, Gear Coupling

Category "S" for switchgear installations and overhead lines.



Type PHE4 ...	3 S ZK	6 S ZK	10 S ZK	20 S ZK	30 S ZK
Part. No.	783 103	783 106	783 110	783 120	783 130
Nominal voltage (U _N)	3 kV	6 kV	10 kV	20 kV	30 kV
Total length (l _G)	1070 mm	1070 mm	1070 mm	1240 mm	1760 mm
Insertion depth (l _o)	230 mm	230 mm	230 mm	400 mm	920 mm

Nominal Voltages up to bis 30 kV / 50 Hz, Gear Coupling

Category "S" for switchgear installations and overhead lines.

Type PHE4 ...	3 10 S ZK	6 20 S ZK	10 30 S ZK
Part. No.	783 141	783 151	783 161
Nominal voltage (U _N)	3 ... 10 kV	6 ... 20 kV	10 ... 30 kV
Total length (l _G)	1450 mm	1640 mm	1760 mm
Insertion depth (l _o)	610 mm	800 mm	920 mm

Nominal Voltages up to 36 kV / 60 Hz, M12 Thread

Category "S" for switchgear installations and overhead lines.



General Information:					
Frequency		60 Hz			
Type PHE4 ...	3 10 S 60	6 20 S 60	10 30 S 60	20 36 S 60	U 3 36 S 60
Part. No.	783 332	783 335	783 345	783 342	783 395
Nominal voltage (U _N)	3 ... 10 kV	6 ... 20 kV	10 ... 30 kV	20 ... 36 kV	3 ... 10 / 12 ... 36 kV
Total length (l _G)	1410 mm	1600 mm	1720 mm	1720 mm	1720 mm
Insertion depth (l _o)	610 mm	800 mm	920 mm	920 mm	920 mm

Nominal Voltage up to 20 kV / 50 Hz or 16.7 Hz, switchable

Category "S" for switchgear installations and overhead lines.

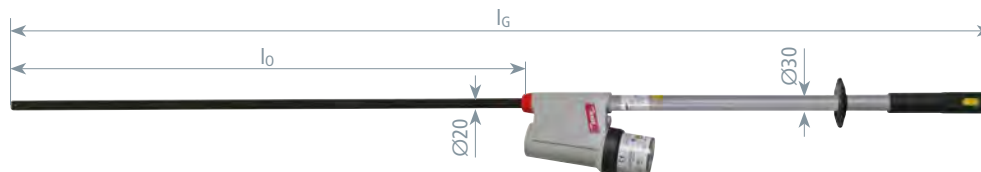

Type PHE4 ...	U 6 20 S 16.7 50
Part. No.	783 430
Nominal voltage (U _N)	6 ... 20 kV
Frequency	50 / 16.7 Hz
Total length (l _G)	1600 mm
Insertion depth (l _o)	800 mm

Nominal Voltage up to 20 kV / 16.7 Hz, M12 Thread

Category "S" for switchgear installations and overhead lines.



Type PHE4 ...	6 20 S 16.7
Part. No.	783 420
Nominal voltage (U _N)	6 ... 20 kV
Frequency	16.7 Hz
Total length (l _G)	1600 mm
Insertion depth (l _o)	800 mm

3. Verify that the Installation is dead – DEHNcheck Voltage Detectors

PHE4 Voltage Detector Nominal Voltage 30 ... 420 kV

- High nominal voltage range
- Unique plug-in coupling system
- Integrated visual and acoustic indication
- Also for use in wet weather conditions



PHE4 voltage detector applied in a 110 kV outdoor switching station.

General Information:	
Standard	EN/IEC 61243-1 (DIN VDE 0682-411)
Temperature range	-25 °C ... +70 °C, climatic category N and W
Design	Complete
For use in wet weather conditions	
For	Indoor and outdoor installations
Indication	Acoustic and visual
Self-testing element	Yes
Material (test electrode)	Cu-alloy/gal Sn
Material (test prod)	PP
Material (indicator)	Plastic, fully insulated
Material (insulating stick)	Glass-fibre reinforced polyester tube

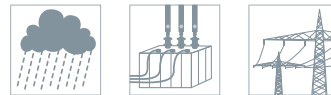

Nominal Voltage Range 30 ... 132 kV / 50 Hz, M12 Thread

Category "S" for switchgear installations and overhead lines.

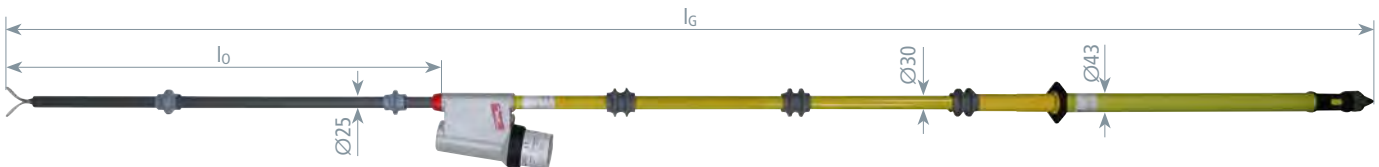

Type PHE4 ...	30 60 S	60 110 S	60 132 S
Part. No.	783 270	783 275	783 280
Nominal voltage (UN)	30 ... 60 kV	60 ... 110 kV	60 ... 132 kV
Total length (lG)	2560 mm	3010 mm	3420 mm
Insertion depth (l0)	910 mm	910 mm	910 mm

Nominal Voltage Range 110 ... 132 kV / 50 & 16.7 Hz, M12 Thread

Category "S" for switchgear installations and overhead lines.

Type PHE4 ...	110 132 S 16.7 50
Part. No.	783 460
Nominal voltage (UN)	110 ... 132 kV
Frequency	50 & 16.7 Hz
Total length (lG)	3420 mm
Insertion depth (l0)	910 mm

Nominal Voltage Ranges 110 ... 420 kV / 50 Hz, M12 Thread

Category "S" for switchgear installations and overhead lines.

Type PHE4 ...	110 220 S	220 420 S
Part. No.	783 285	783 290
Nominal voltage (UN)	110 ... 220 kV	220 ... 420 kV
Total length (lG)	4420 mm	5750 mm
Insertion depth (l0)	910 mm	910 mm

3. Verify that the Installation is dead – DEHNcheck Voltage Detectors

PHE4 Voltage Detector (British Influenced Voltage Level)



PHE4 voltage detector with visual and acoustic indication.

- Self-test of all live parts (including test prod category "S")
- Unique plug-in coupling system
- Integrated visual and acoustic indication
- Also for use in wet weather conditions

General Information:	
Standard	EN/IEC 61243-1 (DIN VDE 0682-411)
Temperature range	-25 °C ... +70 °C, climatic category N and W
Design	Complete
For use in wet weather conditions	
For	Indoor and outdoor installations
Indication	Acoustic and visual
Self-testing element	Yes
Material (test electrode)	Copper alloy/gal Sn
Material (test prod)	Glass-fibre reinforced epoxy resin tube
Material (indicator)	Plastic, fully insulated
Material (insulating stick)	Glass-fibre reinforced polyester tube

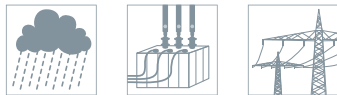

Nominal Voltages up to 33 kV / 50 Hz, M12 Thread

Category "S" for switchgear installations and overhead lines.



Type PHE4 ...	3.3 S	6.6 S	11 S	22 S	33 S
Part. No.	783 033	783 066	783 011	783 022	783 045
Nominal voltage (UN)	3.3 kV	6.6 kV	11 kV	22 kV	33 kV
Total length (lG)	1030 mm	1030 mm	1030 mm	1200 mm	1720 mm
Insertion depth (l0)	230 mm	230 mm	230 mm	400 mm	920 mm

Nominal Voltage Ranges up to 33 kV / 50 Hz, M12 Thread

Category "S" for switchgear installations and overhead lines.

Type PHE4 ...	3.3 11 S	6.6 22 S	11 33 S
Part. No.	783 233	783 243	783 255
Nominal voltage (UN)	3.3 ... 11 kV	6.6 ... 22 kV	11 ... 33 kV
Total length (lG)	1410 mm	1600 mm	1720 mm
Insertion depth (l0)	610 mm	800 mm	920 mm

Nominal Voltage Ranges up to 33 kV / 50 Hz, switchable, M12 Thread

Category "S" for switchgear installations and overhead lines.

Type PHE4 ...	U 6.6 11 S	U 3.3 33 S
Part. No.	783 511	783 533
Nominal voltage (UN)	6.6 / 11 kV	3.3 ... 11 / 11 ... 33 kV
Total length (lG)	1030 mm	1720 mm
Insertion depth (l0)	230 mm	920 mm

3. Verify that the Installation is dead – DEHNcheck Voltage Detectors

PHE III Voltage Detector

Nominal voltages up to 30 kV / 50 Hz
Safe verification of isolation from supply voltage

- Reliable indication
- Easy to use
- Cost-effective / space-saving transport

General Information:	
Standard	EN/IEC 61243-1 (DIN VDE 0682-411)
Temperature range	-25 °C ... +55 °C, climatic category N
Design	Complete
For use in wet weather conditions	
For	Indoor and outdoor installations
Indication	Acoustic and visual
Self-testing element	Yes
Material (test electrode)	Copper alloy/gal Sn
Material (test prod)	Glass-fibre reinforced epoxy resin tube
Material (indicator)	Plastic, fully insulated
Material (insulating stick)	Glass-fibre reinforced polyester tube



PHE III voltage detector with visual and acoustic indicator used for an indoor switchgear installation

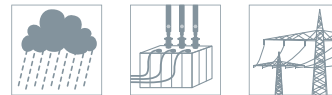

Nominal Voltages up to 30 kV / 50 Hz, M12 Thread

Category "S" for switchgear installations and overhead lines.

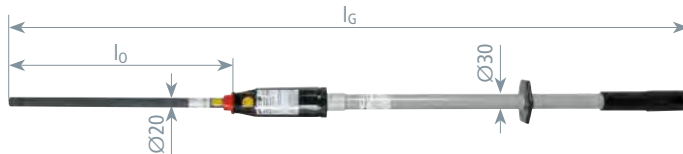

Type PHE3 ...	3 S	6 S	10 S	20 S	30 S
Part. No.	767 703	767 706	767 710	767 720	767 730
Nominal voltage (U _N)	3 kV	6 kV	10 kV	20 kV	30 kV
Total length (l _G)	1080 mm	1080 mm	1080 mm	1230 mm	1415 mm
Insertion depth (l ₀)	285 mm	285 mm	285 mm	435 mm	620 mm

Type PHE3 ...	3.3 S SN7130	6.6 S SN7101	11 S SN7116	22 S SN7128	33 S SN7129
Part. No.	767 798	767 707	767 719	767 756	767 757
Nominal voltage (U _N)	3.3 kV	6.6 kV	11 kV	22 kV	33 kV
Total length (l _G)	1080 mm	1080 mm	1080 mm	1230 mm	1415 mm
Insertion depth (l ₀)	285 mm	285 mm	285 mm	435 mm	620 mm

Nominal Voltage Ranges up to 30 kV / 50 Hz, M12 Thread

Category "S" for switchgear installations and overhead lines

Type PHE3 ...	3 10 S	3.3 11 S SN7127	6 20 S	6.6 22 SN7197	10 30 S	11 33 S SN7264
Part. No.	767 711	767 758	767 721	767 769	767 731	767 773
Nominal voltage (U _N)	3 ... 10 kV	3.3 ... 11 kV	6 ... 20 kV	6.6 ... 22 kV	10 ... 30 kV	11 ... 33 kV
Total length (l _G)	1415 mm	1415 mm	1575 mm	1575 mm	1675 mm	1675 mm
Insertion depth (l ₀)	620 mm	620 mm	780 mm	780 mm	880 mm	880 mm

Nominal Voltage Ranges up to 30 kV / 50 Hz, M12 Thread, switchable

The nominal voltage selector switch allows to switch between two nominal voltage ranges. For safety reasons, the voltage detector can only be switched on if the selector switch is switched to the most sensitive range of 3 kV to 10 kV. The switch snaps into the relevant position, thus providing protection against inadvertent switching. A magnetically operated, wear-resistant reed switch changes the switching position. Category "S" for switchgear installations and overhead lines.

Type PHE3 ...	U 3 30 S	U 3.3 33 SN7108
Part. No.	767 733	767 774
Nominal voltage (U _N)	3 ... 10 / 10 ... 30 kV	3.3 ... 11 / 11 ... 33 kV
Total length (l _G)	1675 mm	1675 mm
Insertion depth (l ₀)	880 mm	880 mm

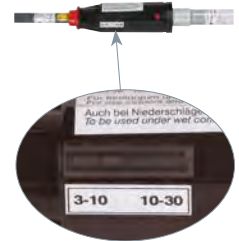

Nominal Voltages up to 25 kV / 50 Hz

For the overhead contact lines of electric railways.
Category "S" for single-ended monophasic systems.

Type PHE3 ...	25 S 50 1P
Part. No.	767 125
Nominal voltage (U _N)	25 kV
Total length (l _G)	1680 mm
Insertion depth (l ₀)	880 mm



3. Verify that the Installation is dead – DEHNcheck Voltage Detectors

Nominal Voltages up to 30 kV / 50 kV, Gear Coupling

Category "S" for switchgear installations and overhead lines.

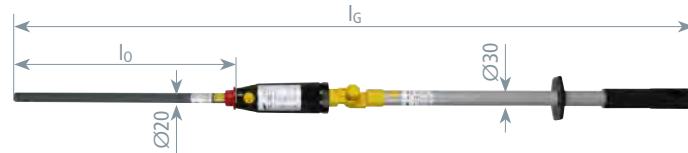

Type PHE3 ...	3 S ZK	6 S ZK	10 S ZK	20 S ZK	30 S ZK
Part. No.	767 903	767 906	767 910	767 920	767 930
Nominal voltage (UN)	3 kV	6 kV	10 kV	20 kV	30 kV
Total length (lG)	1150 mm	1150 mm	1150 mm	1300 mm	1485 mm
Insertion depth (l0)	285 mm	285 mm	285 mm	435 mm	620 mm

Nominal Voltage Ranges up to 30 kV / 50 Hz, Gear Coupling

Category "S"

Type PHE3 ...	3 10 S ZK	6 20 S ZK	10 30 S ZK
Part. No.	767 941	767 951	767 961
Nominal voltage (UN)	3 ... 10 kV	6 ... 20 kV	10 ... 30 kV
Total length (lG)	1485 mm	1645 mm	1745 mm
Insertion depth (l0)	620 mm	780 mm	880 mm

Nominal Voltage Ranges up to 36 kV / 50 Hz, Gear Coupling, switchable

The nominal voltage selector switch allows to switch between two nominal voltage ranges. For safety reasons, the voltage detector can only be switched on if the selector switch is switched to the most sensitive range of (3 kV to 10 kV or 6 kV to 20 kV). The switch snaps into the relevant position, thus providing protection against inadvertent switching. A magnetically operated, wear-resistant reed switch changes the switching position.

Category "S" for switchgear installations and overhead lines.

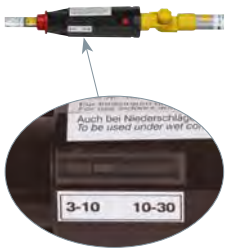

Type PHE3 ...	U 3 30 S ZK	U 6 36 S SN7728
Part. No.	767 960	767 944
Nominal voltage (UN)	3 ... 10 / 10 ... 30 kV	6 ... 20 / 20 ... 36 kV
Total length (lG)	1745 mm	1745 mm
Insertion depth (l0)	880 mm	880 mm

Nominal Voltage Ranges up to 30 kV / 50 Hz, Test Kit, Thread M12

With two test prods of Category "S" for switchgear installations and overhead lines and of Category "L" for overhead lines.

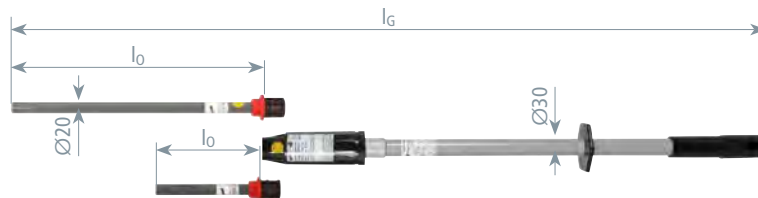

Type PHE3 ...	6 20 SL	10 30 SL
Part. No.	767 740	767 750
Nominal voltage (UN)	6 ... 20 kV	10 ... 30 kV
Total length (lG)	1575 / 980 mm	1675 / 980 mm
Insertion depth (l0)	780 / 185 mm	880 / 185 mm

Nominal Voltage Ranges up to 30 kV / 50 Hz, Test Kit, Gear Coupling

With two test prods of Category "S" for switchgear installations and overhead lines and of Category "L" for overhead lines.

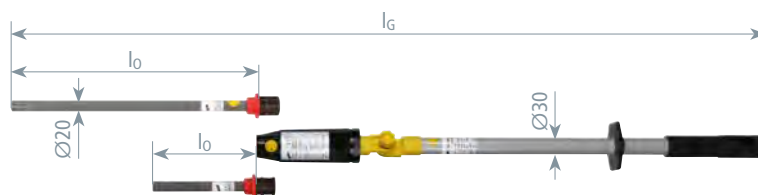

Type PHE3 ...	6 20 SL ZK	10 30 SL ZK
Part. No.	767 940	767 950
Nominal voltage (UN)	6 ... 20 kV	10 ... 30 kV
Total length (lG)	1650 / 1050 mm	1750 / 1050 mm
Insertion depth (l0)	780 / 185 mm	880 / 185 mm

3. Verify that the Installation is dead – DEHNcheck Voltage Detectors

PHE III ZK Indicator with Test Prod

- Nominal voltages up to 30 kV / 50 Hz
 Safe verification of isolation from supply voltage
- Reliable indication with standby function
 - Easy to use
 - Cost-effective / space-saving transport

General Information:	
Standard (indicator with test prod)	EN/IEC 61243-1 (DIN VDE 0682-411)
Standard (universal gear coupling)	EN/IEC 60832 (DIN VDE 0682-211)
Temperature range	-25 °C ... +55 °C, climatic category N
Design	Separate
For use in wet weather conditions	
For	Indoor and outdoor installations
Indication	Acoustic and visual
Self-testing element	Yes
Material (test electrode)	Copper alloy/gal Sn
Material (test prod)	Glass-fibre reinforced epoxy resin tube
Material (indicator)	Plastic, fully insulated



PHE III indicator with test prod, universal gear coupling and insulating stick

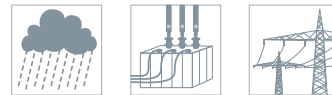

Standby function

The PHE III indicator with test prod has a standby function meaning that the device is automatically activated as soon as contact with energised equipment is made (without previous self-test) and visually and acoustically indicates "voltage present". When making contact with de-energised equipment, the indicator is not activated.

Attention

The PHE III indicator with test prod may only be used in combination with a suitably rated insulating stick.

Nominal Voltage Ranges up to 30 kV / 50 Hz, Category "S"

Category "S" for switchgear installations and overhead lines.

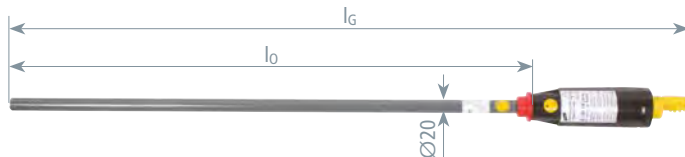

Type PHE3 ...	PK6 20 S SB ZK	PK10 30 S SB ZK
Part. No.	767 921	767 931
Nominal voltage (U _N)	6 ... 20 kV	10 ... 30 kV
Total length (l _G)	1010 mm	1110 mm
Insertion depth (l _o)	780 mm	880 mm

Nominal Voltage Ranges up to 30 kV / 50 Hz, Category "L"

Category "L" for overhead lines.

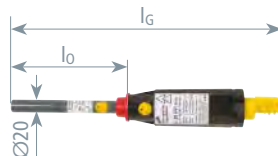

Type PHE3 ...	PK6 20 L SB ZK	PK10 30 L SB ZK
Part. No.	767 922	767 932
Nominal voltage (U _N)	6 ... 20 kV	10 ... 30 kV
Total length (l _G)	415 mm	415 mm
Insertion depth (l _o)	185 mm	185 mm

3. Verify that the Installation is dead – DEHNcheck Voltage Detectors

Accessories for PHE III ZK Indicator with Test Prod

Telescopic Insulating Stick, with universal Gear Coupling

With scale for measuring the ground clearance, mounted support included.

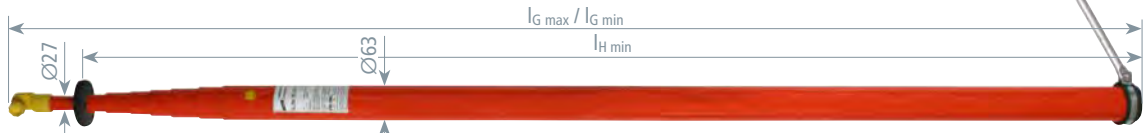

Type	ISMTC N 36 ZK 10600
Part. No.	766 037
Nominal voltage (UN)	Up to 36 kV
Total length (lG max / lG min)	10,600 / 1750 mm
Length (handle) (lH)	1680 mm
Material	Glass-fibre reinforced epoxy resin tube

For PHE4 and PHE III, with universal Gear Coupling

Handle end fitting with plastic plug-in coupling as extension handle.

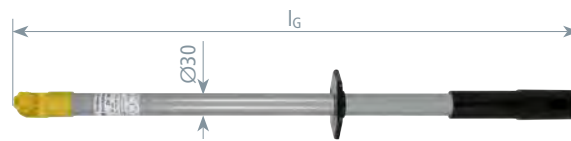

Type	IS ZK STK 670
Part. No.	766 368
Total length (lG)	670 mm
Length (handle) (lH)	265 mm
Diameter	30 mm
Material	Glass-fibre reinforced polyester tube

3. DEHNcheck Voltage Detectors

PHE III Voltage Detector Kit



PHE III voltage detector used on a 110 kV outdoor station

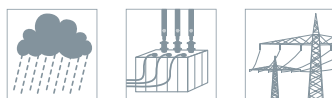

Nominal voltage 20 and 60 ... 110 kV / 50 Hz
Safe verification of isolation from supply voltage

- Reliable indication
- Easy to use
- Multi-purpose kit
- Cost-effective / space-saving transport

General Information:	
Standard	EN/IEC 61243-1 (DIN VDE 0682-411)
Temperature range	-25 °C ... +55 °C, climatic category N
Design	Complete
For use in wet weather conditions	
For	Indoor and outdoor installations
Indication	Acoustic and visual
Self-testing element	Yes
Material (test electrode)	Copper alloy/gal Sn
Material (test prod)	Glass-fibre reinforced epoxy resin tube
Material (indicator)	Plastic, fully insulated
Material (insulating stick)	Glass-fibre reinforced polyester tube

3. Verify that the Installation is dead – DEHNcheck Voltage Detectors

Nominal Voltage 20 kV / 50 Hz

Category "S" for switchgear installations and overhead lines.

Parts list:			
Pos.	Part No.	Pos.	Part No.
1	766 927	11	766 335
2	766 924	12	766 115
3	766 960	13	766 116
4	767 763	14	766 117
5	767 771	15	766 120
6	769 701	16	766 077
7	767 722*	17	766 889
8	767 734*	18	767 996
9	769 713	19	766 998
10	766 368		

For more detailed information on these products, see Accessories chapter or www.dehn-international.com.

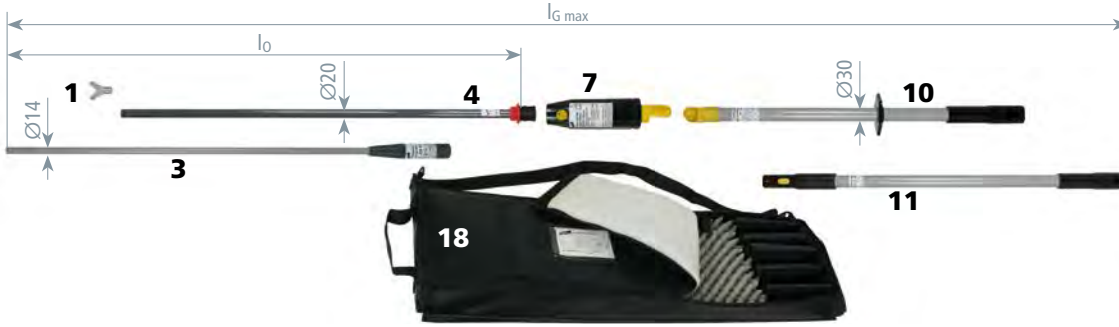

Type	PHE3S 20 S ZK
Part. No.	767 724
Nominal voltage (UN)	20 kV
Total length (lG max)	3080 mm
Insertion depth (l0 max)	1580 mm

Possible lengths:		
Length lG	Insertion depth l0	Pos. Nr.
3080 mm	1580 mm	3+4+7+10+11
2290 mm	800 mm	1+4+7+10+11
1660 mm	800 mm	1+4+7+10

Nominal Voltage Range 60 ... 110 kV / 50 Hz

Category "S" for switchgear installations and overhead lines.

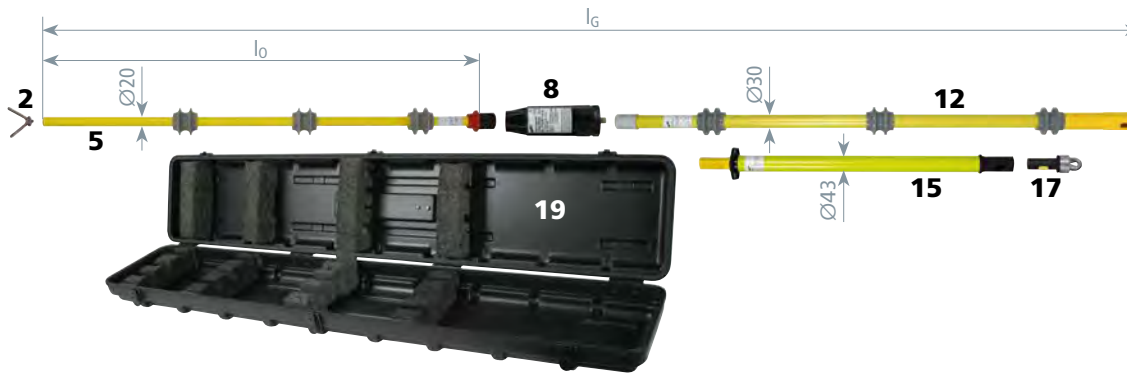

Type	PHE3S2 60 110 S
Part. No.	767 980
Nominal voltage (UN)	60 ... 110 kV
Total length (lG)	2980 mm
Insertion depth (l0)	880 mm

Kit includes:		
Type	Part No.	Pos. Nr.
PHE3 60 110 S	767 990	2+5+8+12+15+17
KKL PHE3 60 110	766 998	19

Nominal Voltage Range 60 ... 110 kV / 50 Hz CODED

Special test prod and indicator are mutually coded, i.e. no other test prod fits mechanically for the used indicator. Thus confusion of test prods is avoided.

Category "S" for switchgear installations and overhead lines as coded type.

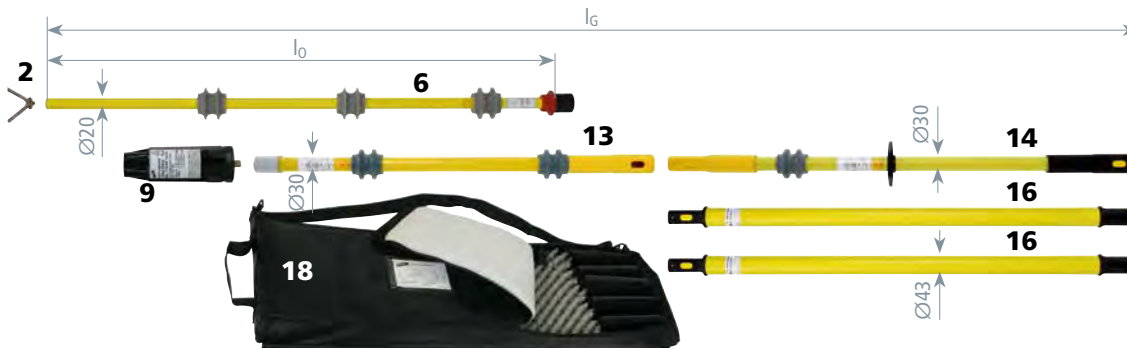

Type	PHE3S60 110S CSN7774
Part. No.	769 712
Nominal voltage (UN)	60 ... 110 kV
Total length (lG max / lG min)	4470 / 2840 mm
Insertion depth (l0)	880 mm

Kit includes:		
Type	Part No.	Pos. Nr.
PHE360 110SITCSN7773	769 710	2+6+9+13+14
HV STK 43 975	766 077	(2x) 16
KKL PHE3 60 110	767 996	18

3. Verify that the Installation is dead – DEHNcheck Voltage Detectors

PHE Voltage Detector



PHE voltage detector with visual indication



Nominal voltages up to 20 kV / 50 Hz or 16.7 Hz

Easy and safe testing

- Reliable indication
- Easy to use

General Information:

Standard	EN/IEC 61243-1 (DIN VDE 0682-411) and E DIN VDE 0682-421
Temperature range	-25 °C ... +55 °C, climatic category N
Design	Complete
For use in wet weather conditions	
For	Indoor and outdoor installations
Indication	Visual
Self-testing element	Yes
Material (test electrode)	Copper alloy/gal Sn
Material (test prod)	Glass-fibre reinforced epoxy resin tube
Material (indicator)	Plastic, fully insulated
Material (insulating stick)	Glass-fibre reinforced polyester tube

Nominal Voltage Ranges 20 kV / 50 Hz or 16.7 Hz, switchable

For three-phase systems and single-ended monophas switchgear installations.

Special features of the switchable voltage detector:

The selector switch can be moved into three positions for the relevant voltage and frequency ranges:

3 ... 10 kV / 50 Hz – three-phase systems

6 ... 20 kV / 50 Hz – three-phase systems

6 ... 20 kV / 16.7 Hz – single-ended monophas systems

For safety reasons, the detector can only be switched on if the selector switch is switched to the most sensitive range of 3 kV to 10 kV / 50 Hz. The switch snaps into the relevant position and provides protection against accidental switching. A magnetically operated, wear-resistant reed switch changes the switching position.

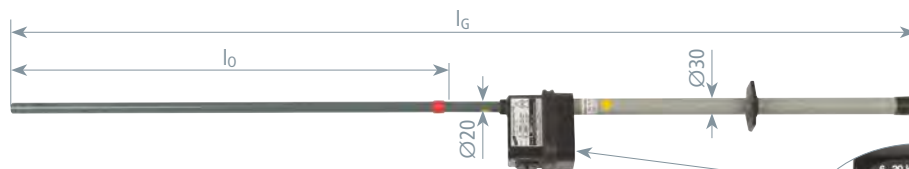

Type PHE ...	3 20 S FU 1P
Part. No.	767 416
Nominal voltage (U _N)	3 ... 20 kV
Frequency	16.7 and 50 Hz
Total length (l _G)	1560 mm
Insertion depth (l ₀)	770 mm
DB drawing No.	3 Ebgw 02.54
DB material No.	743 361



3. Verify that the Installation is dead – DEHNcheck Voltage Detectors

Nominal Voltage Ranges up to 20 kV / 16.7 Hz

For single-ended monophase switchgear installations and point heating systems.

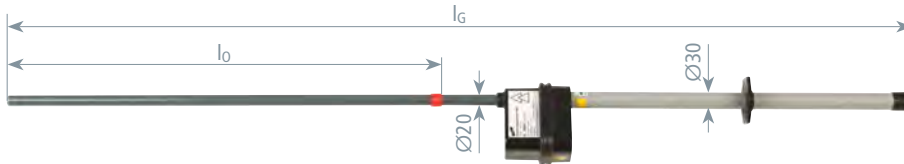

Type PHE ...	6 20 S 16.7 1P
Part. No.	767 415
Nominal voltage (U _N)	6 ... 20 kV
Frequency	16.7 Hz
Total length (l _G)	1560 mm
Insertion depth (l _o)	770 mm
DB drawing No.	3 Ebgw 02.52
DB material No.	738 302



Nominal Voltage 15 kV / 16.7 Hz

For traction power lines.

Hook-shaped electrode and end fitting with plug-in coupling and non-slip eye included.

Use for traction power lines

Voltage detectors for traction power lines have a shorter extension than voltage detectors for overhead contact lines. To ensure reliable indication, the PHE 15 16.7 BEL STK voltage detector may only be used for traction power lines and not for other components of overhead contact lines. Moreover, it must not be used from ladder trolleys for overhead contact lines.

Traction power lines are supply lines, line feeders, bypass lines, connecting lines, feeder lines, 15 kV cables, cable sealing ends, switch lines and transverse switch lines.

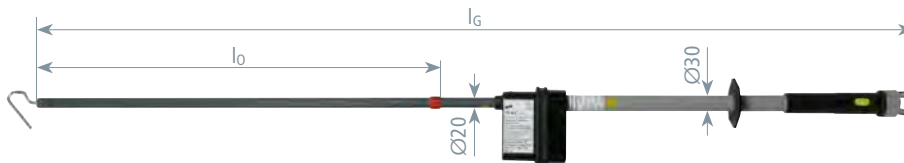

Type PHE ...	15 16.7 BEL STK
Part. No.	767 413
Nominal voltage (U _N)	15 kV
Frequency	16.7 Hz
Total length (l _G)	1645 mm
Insertion depth (l _o)	765 mm
DB drawing No.	3 Ebgw 02.55
DB material No.	964 851



3. Verify that the Installation is dead – DEHNcheck Voltage Detectors

PHE Voltage Detector Kit



PHE voltage detector with visual indicator used on an overhead contact line of German Railways (DB)

Nominal voltage 15 kV / 16.7 Hz

Easy and safe testing

- For overhead contact lines of electric railways
- Cost-effective / space-saving transport
- Easy to use due to simple plug-in system

General Information:	
Standard	DIN VDE 0681-6
For use in wet weather conditions	
Anzeige	Visual
Self-testing element	Yes
Material (test electrode)	St/gal Zn
Material (test prod)	Glass-fibre reinforced polyester tube
Material (indicator)	Plastic, fully insulated
Material (insulating stick)	Glass-fibre reinforced polyester tube

Parts list:			
Pos.	Part. No.	Pos.	Part. No.
1	766 619	7	766 076
2	766 678*	8	766 077
3	766 677*	9	766 889
4	766 072	10	766 602
5	766 075	11	766 704
6	766 073		

For more detailed information on these products, see Accessories chapter or * www.dehn-international.com



Nominal Voltage 15 kV / 16.7 Hz

Detachable (four elements).

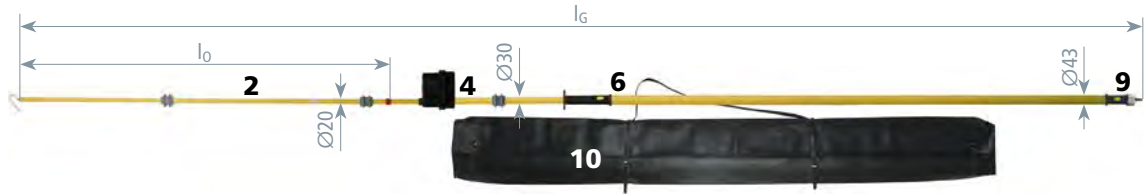

Type PHE 15 16.7 ...	4T TA
Part. No.	766 616
Nominal voltage (U _N)	15 kV
Frequency	16.7 Hz
Total length (l _G)	4890 mm
Insertion depth (l ₀)	1675 mm
DB drawing No.	3 Ebgw 02.51
DB material No.	237 129

Nominal Voltage 15 kV / 16.7 Hz (for Transport in Motor Vehicles)

Detachable (six elements).



Two-part test prod with robust threaded coupling (six-part kit for transport in motor vehicles)

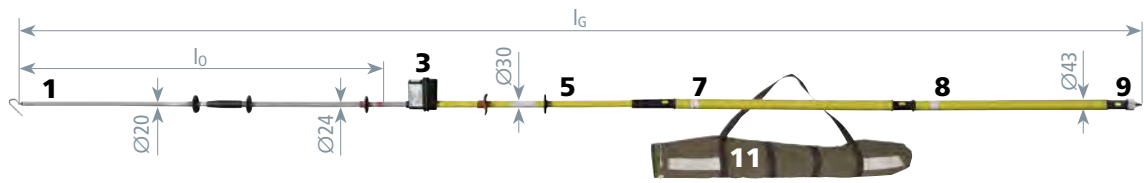

Type PHE 15 16.7 ...	6T TA
Part. No.	766 617
Nominal voltage (U _N)	15 kV
Frequency	16.7 Hz
Total length (l _G)	4900 mm
Insertion depth (l ₀)	1675 mm
DB drawing No.	3 Ebgw 02.53
DB material No.	652 975

3. Verify that the Installation is dead – DEHNcheck Voltage Detectors

PHG II Voltage Detector

Nominal voltages up to 20 kV / 50 Hz

Easy and safe testing

- Cost-effective
- Reliable indication

General Information:	
Standard	EN/IEC 61243-1 (DIN VDE 0682-411)
Temperature range	-25 °C ... +55 °C, climatic category N
Design	Complete
Only for indoor installations	
For	Indoor installations
Indication	Visual, 3 LEDs
Function	Passive voltage detector without batteries
Material (test electrode)	Cu/gal Sn
Material (test prod)	Glass-fibre reinforced polyester tube
Material (indicator)	Plastic
Material (insulating stick)	Glass-fibre reinforced polyester tube



PHG II voltage detector used in a type-tested switchgear installation

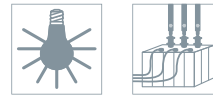

Test for correct operation

The EN 50110-1 (DIN VDE 0105-100) standard requires that voltage detectors be tested for correct operation directly before and after they are used.

Voltage detectors without self-testing element must be tested for correct operation by contacting parts of the installation connected to operating voltage.

On the test prod of the voltage detector there is a fork-shaped electrode.

Nominal Voltages up to 20 kV / 50 Hz

Category "S" for indoor switchgear installations.

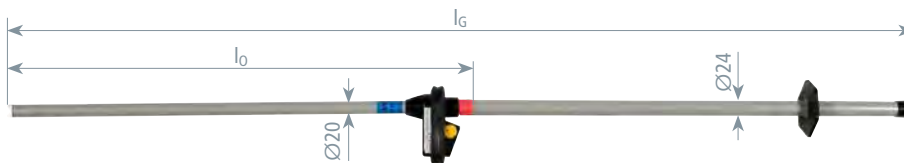

Type PHG2 ...	6	10	20
Part. No.	766 706	766 710	766 720
Nominal voltage (U _N)	6 kV	10 kV	20 kV
Total length (l _G)	1425 mm	1425 mm	1425 mm
Insertion depth (l _o)	720 mm	720 mm	720 mm

3. Verify that the Installation is dead – **DEHNcheck Voltage Detectors**

ASP Non-Contact Voltage Detector Kit



Use of an ASP distance voltage detector in an outdoor switching station



Nominal voltage range 110 ... 420 kV / 16.7 and 50 Hz

Easy and safe testing

- Easy to use due to compact design
- Cost-effective / space-saving transport

General Information:	
Temperature range	-25 °C ... +55 °C
For use in wet weather conditions	
For	Overhead lines and outdoor switching stations
Indication	Acoustic and visual
Self-testing element	Yes
Material (indicator)	Plastic, fully insulated, black
Material (electric field sensor)	Plastic, black
Material (insulating stick)	Glass-fibre reinforced polyester tube

Parts list:			
Pos.	Part No.	Pos.	Part No.
1	767 576*	6	767 564*
2	767 577*	7	766 369
3	767 591*	8	767 574
4	767 592*	9	767 996
5	767 593*		

For more detailed information on these products, see Accessories chapter or * www.dehn-international.com

Category "S" and "L"

Devices of category "S" may only be used in outdoor switching stations, devices of category "L" for overhead lines only. Devices of category "S" / "L" may be used both for outdoor switching stations and overhead lines.

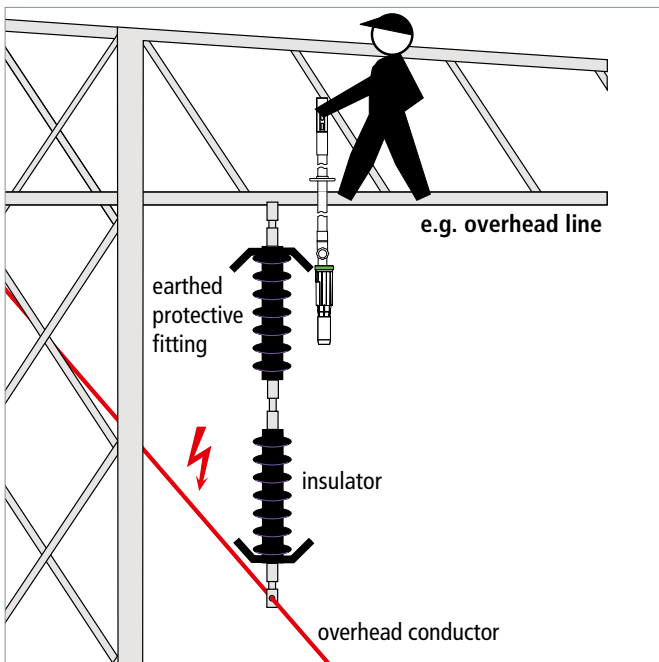

Use for overhead lines

The green ring on the ASP distance voltage detector with category "L" electric field sensor is used to make contact with the last earthed protective fitting in such a way that the electric field sensor points in the direction of the overhead conductor fixed at the other end of the insulator.

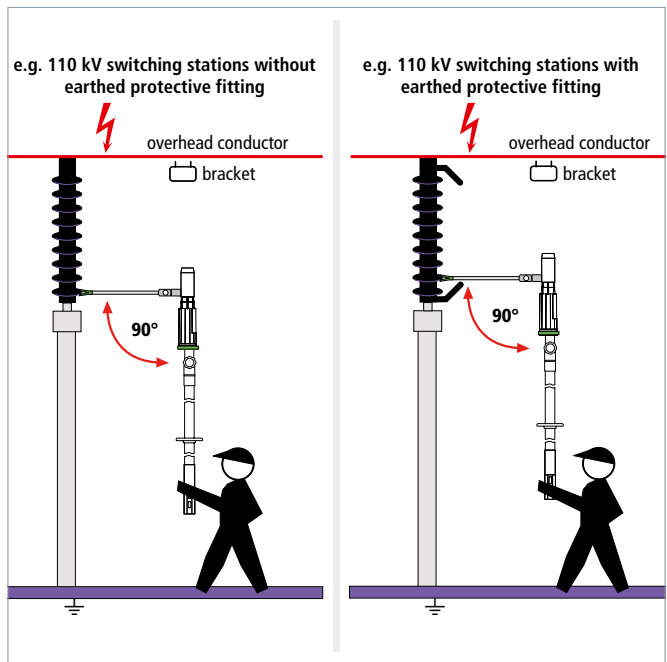

Use in outdoor switching stations

The green ring on the arm of the ASP distance voltage detector with category "S" electric field sensor is used to make contact with the lowest insulator plate at a right angle. If an earthed protective fitting is available, contact is made at the next possible insulator plate above the protective fitting.

3. Verify that the Installation is dead – DEHNcheck Voltage Detectors

Category "L", 50 Hz

Category "L" for overhead lines in accordance with the DIN VDE V 0682-417/10.2013 preliminary standard.

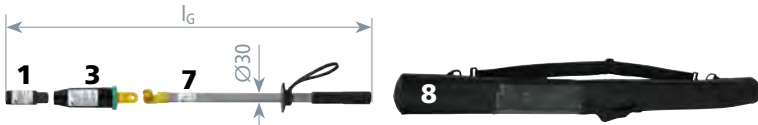

Type ASPS 110 ...	420 L
Part. No.	767 571
Nominal voltage (U _N)	110 ... 420 kV
Frequency	50 Hz
Total length (l _G)	960 mm

Kit includes:		
Type	Part. No.	Pos.-Nr.
ASP 110 420 L	767 581	1+3+7
KLT 104 9	767 574	8

Category "L", 16.7 Hz

Category "L" for centre-earthed monophase traction power lines.

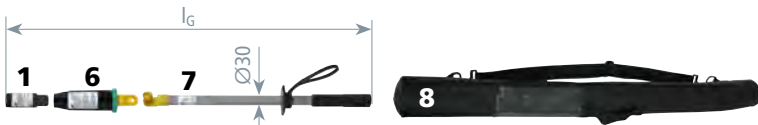

Type ASPS 110 ...	132 16.7 L
Part. No.	767 565
Nominal voltage (U _N)	110 ... 132 kV
Frequency	16.7 Hz
Total length (l _G)	960 mm
DB drawing no.	3 Eku 710 002

Kit includes:		
Type	Part. No.	Pos.-Nr.
ASP 110 132 16.7 L	767 585	1+6+7
KLT 104 9	767 574	8



Category "S", 50 Hz

Category "S" for outdoor switching stations.



Type ASPS 110 ...	420 S
Part. No.	767 572
Nominal voltage (U _N)	110 ... 420 kV
Frequency	50 Hz
Total length (l _G)	1000 mm

Kit includes:		
Type	Part. No.	Pos.-Nr.
ASP 110 420 S	767 582	2+4+7
KLT 104 9	767 574	8

Category "S / L", 50 Hz

Category "S / L" for overhead lines and outdoor switching stations.

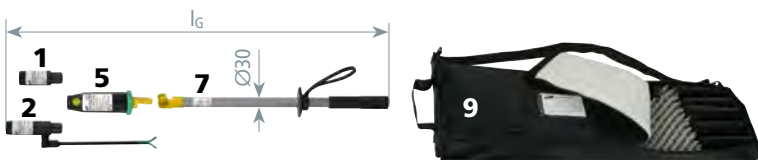

Type ASPS 110 ...	420 S L
Part. No.	767 573
Nominal voltage (U _N)	110 ... 420 kV
Frequency	50 Hz
Total length (l _G)	1000 mm

Kit includes:		
Type	Part. No.	Pos.-Nr.
ASP 110 420 S L	767 583	1+2+5+7
KLT 101 30 10	767 996	9

3. Verify that the Installation is dead – DEHNcheck Voltage Detectors

HSA 194 High-Voltage Indicator



High-voltage indicator used on a 110 kV overhead line.

Special instructions for the use of HSA 194 110 420 SN7737 (Part No. 767539)

The device can be switched between the "climbing check" mode (switch position when climbing the tower) and the "110 ... 420 kV" mode for verifying that the overhead conductor is dead.

Switch position "climbing check"

When climbing the lattice tower, the switch position "climbing check" allows to check from the corner leg whether the next overhead conductor (or conductor bundle) is still energised when approaching it. During this check, the high-voltage indicator is moved closer towards the next overhead conductor and moved within 0.5 m (see Fig. 1). If the conductor is energised, there is a visual (red flashing light) and acoustic signal.

The minimum distance A (min) (according to the nominal voltage in Table 2) between the operating head of the high-voltage indicator and the overhead conductor must be observed.

The customer must determine the maximum distance A (max) (safe tripping of the high-voltage indicator when approaching the overhead conductor) depending on the nominal voltage and document it in the operating instructions.

Using the high-voltage indicator when climbing lattice towers does not replace verifying absence of voltage from the cross arm.

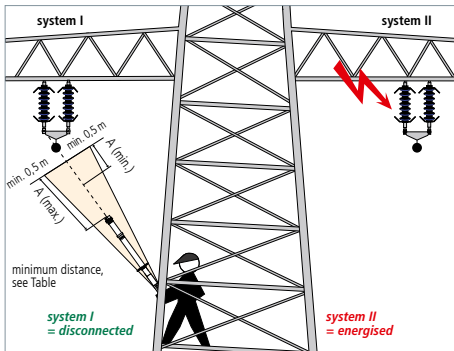

Figure 1: Example of application on the corner leg of a lattice tower with switch position "climbing check" (only HSA 194 110 420 SN7737)

Nominal voltage	Min safety distance A
110 kV	2000 mm
220 kV	3000 mm
380 kV	4000 mm
420 kV	4400 mm

Table

Nominal voltage range 110 ... 420 kV / 16.7 and 50 Hz
Easy and safe testing

- For contactlessly verifying that switchgear and high-voltage overhead lines or centre-earthed monophas traction power lines are dead
- Cost-effective / space-saving transport

General Information:

Temperature range	- 25 °C ... + 55 °C, climatic category N
For use in wet weather conditions	
Indication	Acoustic and visual
Self-testing element	Yes
Material (insulating stick)	Glass-fibre reinforced polyester tube

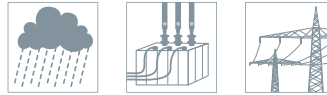

General application notes for the HSA 194

Switch position voltage range "110 ... 420 kV"

To verify absence of voltage from the tower cross arm, place the green ring of the high-voltage indicator on the last earthed protective fitting (or earthed insulator cap) of the insulator so that the operating head of the high-voltage indicator (see Fig. 2) points towards the overhead conductor to be tested, which is attached to the other insulator end (longitudinal axis of the device in parallel to the longitudinal axis of the insulator). If the conductor is energised, there is a visual (red flashing light) and acoustic signal.

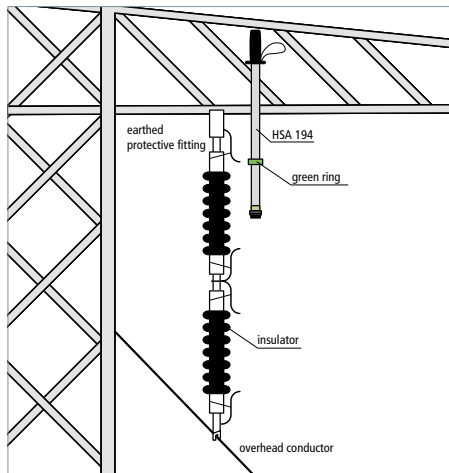
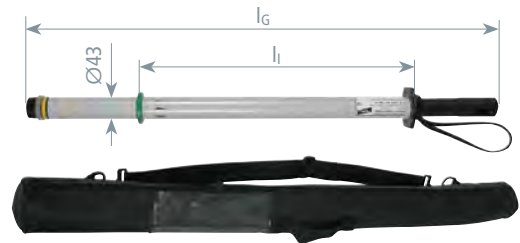

Figure 2: Example of application on the tower cross arm with switch position "110 ... 420 kV"



Nominal Voltage Range 110 ... 420 kV, with verification while climbing the tower

With plug-in coupling as end fitting for extending the handle.
Storage bag included in delivery.

Type	HSA194 110 420 STK	HSA194 110 420 16.7	HSA 194 110 420 SN7737
Part. No.	767 541	767 542	767 539
Nominal voltage range (U _N)	110 ... 420 kV	110 ... 420 kV	110 ... 420 kV
Frequency	50 Hz	16.7 Hz	50 Hz
Total length (l _G)	940 mm	940 mm	940 mm
Insulating clearance (l _I)	540 mm	540 mm	540 mm
Verification while climbing the tower	No	No	Yes
DB drawing No.	—	3 Ekgw 02.54	—

3. Verify that the Installation is dead – DEHNcheck Voltage Detectors

HSA 205 High-Voltage Indicator

Nominal voltage range 1 ... 420 kV / 50 Hz

- For contactlessly verifying that switchgear installations and high-voltage overhead lines are dead
- Wide nominal voltage range

General Information:	
Temperature range	-25 °C ... +55 °C, climatic category N
For use in wet weather conditions	
Indication	Visual and acoustic
Self-testing element	Yes
Material (insulating stick)	Glass-fibre reinforced polyester tube



HSA 205 high-voltage indicator with insulating cap used on a switchgear installation.

Application notes

The operating head of HSA 205 high-voltage indicator is fitted with a yellow switching ring, which is used to set the required nominal voltage range, either 1 to 30 kV, 30 to 220 kV or 110 to 420 kV.

The transparent insulating cap must be used in the voltage range from 1 to 30 kV. Provided that the insulating tube and cap of the high-voltage indicator are in a dry and clean condition, the minimum distance A can be reduced for nominal voltages up to 30 kV.

If these conditions cannot be ensured, the minimum distance A must be maintained!

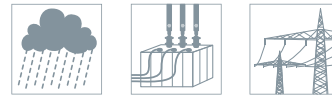

Minimum distances A according to nominal voltage:		
Selected voltage range	Nominal voltage acc. to DIN VDE 0105 Part 1	Min. safety distance A DIN VDE 0105 Part 1
Red 1 ... 30 kV	over 1 up to 6 kV	90 mm indoor installations
	over 6 up to 10 kV	120 mm indoor installations
	over 1 up to 10 kV	150 mm outdoor installations
	over 10 up to 20 kV	220 mm indoor and outdoor installations
	over 20 up to 30 kV	320 mm indoor and outdoor installations
White 30 ... 220 kV	over 30 up to 45 kV	480 mm indoor and outdoor installations
	over 45 up to 60 kV	630 mm indoor and outdoor installations
	over 60 up to 110 kV	1100 mm indoor and outdoor installations
	over 110 up to 220 kV	2100 mm indoor and outdoor installations
	over 110 up to 220 kV	2100 mm indoor and outdoor installations
Yellow 110 ... 420 kV	over 110 up to 220 kV	2100 mm indoor and outdoor installations
	over 220 up to 420 kV	2900/3400 mm indoor and outdoor installations

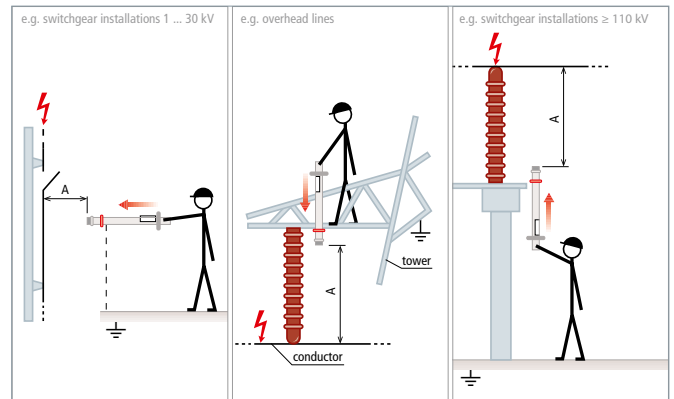

Nominal Voltage Ranges up to 420 kV, switchable

With insulating cap and plug-in coupling as end fitting for extending the handle. Storage bag included in delivery.

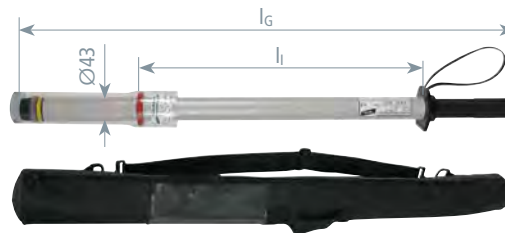

Type HSA205 U 1 ...	420 STK	420SN7608
Part. No.	767 552	767 547 <small>NEW</small>
Nominal voltage range (U _N)	1 ... 30 / 30 ... 220 / 110 ... 420 kV	1 ... 30 / 30 ... 220 / 110 ... 420 kV
Frequency	50 Hz	60 Hz
Total length (l _G)	950 mm	950 mm
Insulating clearance (l _I)	540 mm	540 mm

3. Verify that the Installation is dead – DEHNcheck Voltage Detectors

PHE/G d.c. Voltage Detector



PHE/G II d.c. voltage detector for d.c. links (ICE power car)

Nominal voltages up to 24 kV d.c.
Safe verification of isolation from supply voltage

- For use in direct voltage systems (electrified rail networks, d.c. links)
- Reliable indication
- Easy to use due to compact design
- User-friendly

General Information:	
Standard	Based on EN/IEC 61243-2 (DIN VDE 0682-412)
Temperature range	-25 °C ... +55 °C, climatic category N
For use in wet weather conditions	
For	Indoor and outdoor installations
Indication	Visual
Self-testing element	Yes
Material (test prod)	Glass-fibre reinforced polyester tube
Material (indicator)	Plastic, fully insulated
Material (insulating stick)	Glass-fibre reinforced polyester tube
Material (earthing / connecting cable)	Copper cable, highly flexible

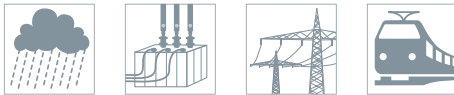

The test prod of d.c. voltage detectors is colour-coded according to the polarity of the test prod:

- positive pole – red;
- negative pole – blue.

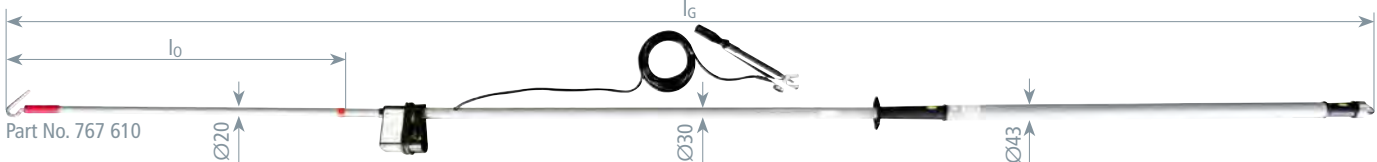

Part No. 767 614

PHE/G I for Overhead Contact Lines, positive pole on indicator with test prod

- One stick (three elements)
- For direct voltage systems with earthed negative pole
 - Positive pole: Indicator with test prod
 - Negative pole: Earth clamp

NEW

Type	PHEG1 FD P 3
Part. No.	767 610 NEW
Threshold voltage (U _t)	1.1 kV
Nominal voltage (U _N)	3.0 kV
Length (earthing cable)	6000 mm
Total length (l _G)	4125 mm
Insertion depth (l ₀)	1015 mm

PHE/G I for Overhead Contact Lines, negative pole on indicator with test prod

- One stick (four elements)
- For d.c. voltage systems with earthed positive pole
 - Negative pole: Indicator with test prod
 - Positive pole: Earth clamp

Type	PHEG1 FD M SN7223
Part. No.	767 614 NEW
Threshold voltage (U _t)	0.825 kV
Nominal voltage (U _N)	1.65 kV
Length (earthing cable)	8000 mm
Total length (l _G)	4160 mm
Insertion depth (l ₀)	1015 mm

PHE/G I for Switchgear Installations, positive pole on Indicator with Test Prod

- One stick
- For direct voltage systems with earthed negative pole
 - Positive pole: Indicator with test prod
 - Negative pole: Earth clamp

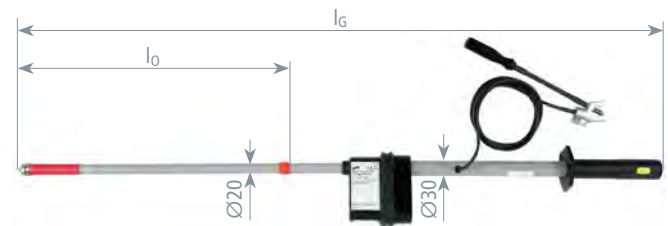

Type	PHEG1.S P SN7401
Part. No.	767 666
Threshold voltage (U _t)	120 V
Nominal voltage (U _N)	1 ... 24 kV
Length (earthing cable)	2000 mm
Total length (l _G)	1260 mm
Insertion depth (l ₀)	535 mm

3. Verify that the Installation is dead – DEHNcheck Voltage Detectors

PHE/G I for Switchgear Installations, **positive pole** on indicator with test prod, angled

One stick

- For direct voltage systems with earthed negative pole
- Positive pole: Indicator with test prod
- Negative pole: Earth clamp

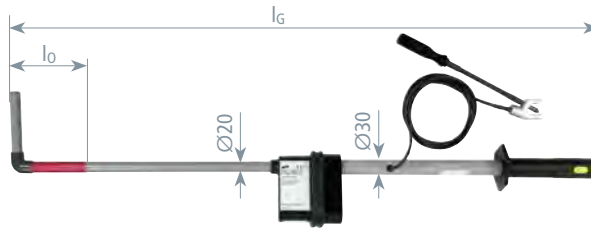

Type	PHEG1 S P SN7240
Part. No.	767 636 <small>NEW</small>
Threshold voltage (U _t)	60 V
Nominal voltage (U _N)	3.8 kV
Length (connecting cable)	4000 mm
Total length (l _G)	1100 mm

PHE/G II for Switchgear Installations

Two sticks

- For unearthed direct voltage installations
- For d.c. links
- Positive pole: Indicator with test prod
- Negative pole: Insulating stick

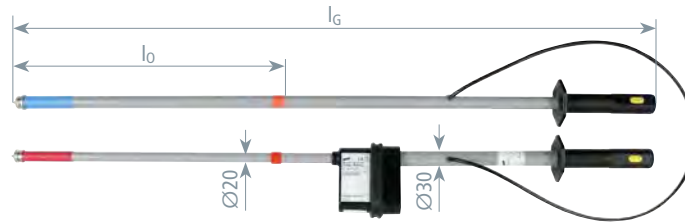

Type	PHEG2.P SN7517
Part. No.	767 671
Threshold voltage (U _t)	90 V
Nominal voltage (U _N)	1 ... 24 kV
Length (connecting cable)	1200 mm
Total length (l _G)	1260 mm
Insertion depth (l ₀)	545 mm

PHE/G II for Switchgear Installations and d.c. Links

Two sticks

- For unearthed direct voltage installations
- For d.c. links (e.g. electric locomotives; Part No. 767 647)
- Positive pole: Indicator with test prod
- Negative pole: Insulating stick

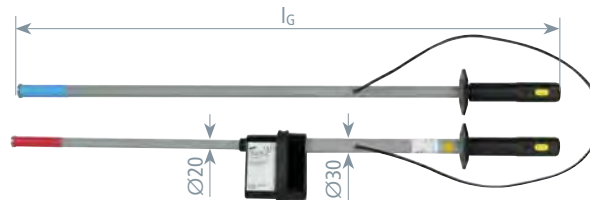

Type	PHEG2 P SN7552	PHEG2 P SN7259	PHEG2 P SN7407	PHEG2 P SN7194
Part. No.	767 647	767 645	767 640 <small>NEW</small>	767 637
Threshold voltage (U _t)	90 V	120 V	350 V	750 V
Nominal voltage (U _N)	1 ... 4.2 kV	1 ... 12 kV	600 ... 750 kV	1.5 kV
Length (connecting cable)	1200 mm	1200 mm	1200 mm	1200 mm
Total length (l _G)	600 mm	1085 mm	1085 mm	1085 mm

PHE/G II, angled **positive pole**

Two sticks

- For unearthed direct voltage installations
- For d.c. links
- Positive pole: Insulating stick
- Negative pole: Test prod

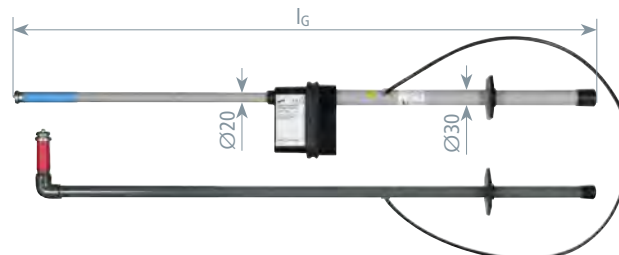

Type	PHEG2 P SN7346
Part. No.	767 639
Threshold voltage (U _t)	150 V
Nominal voltage (U _N)	750 V
Length (connecting cable)	1200 mm
Total length (l _G)	1100 mm

3. Verify that the Installation is dead – DEHNcheck Voltage Detectors

Two-pole SPN Voltage Detector



Two-pole SPN voltage detector used with extension prods for overhead lines



Nominal voltages up to 1000 V

- Extremely shock-resistant, waterproof and dust-proof enclosure
- Test ball with additional phase, rotation field and continuity test
- Two versions with different measuring ranges
- For use in overhead line networks by attaching extension prods
- No battery required

General Information:	
Standard	EN/IEC 61243-3 (DIN VDE 0682-401)
Temperature range	-15 °C ... +45 °C
Degree of protection	IP 65
For use in wet weather conditions	
Material (indicator)	Safety enclosure made of solid rubber
Indication	Direct-reading instrument, LCD and LED
Connecting cable	PUR-sheathed cable, highly flexible, 1000 mm
Overvoltage category	SPN 500B: CAT IV 500 V; SPN 1000B: CAT IV 1000 V

Nominal Voltage Range up to 1000 V

Basic devices.



Type SPN ...	500B	1000B
Part. No.	766 660	766 665
Nominal voltage range (U _N)	50 ... 500 V	50 ... 1000 V
Frequency range	15 ... 500 Hz and DC	15 ... 500 Hz and DC
Dimensions (indicator)	274 x 75 x 47 mm	274 x 75 x 47 mm

Accessories for Two-pole SPN Voltage Detector

Extension Prod

For use in overhead line networks, to be screwed onto the basic device.



Type	VS 500 SPN II
Part. No.	766 542
Length	500 mm

Artificial Leather Bag, empty

For SPN voltage detectors (basic device with extension prods).



Type	AT SPN II
Part. No.	766 543
Dimensions	535 x 160 mm
Colour	Black ●

Design of Phase Comparators

Phase comparators in accordance with EN/IEC 61481-1 (DIN VDE 0682-431-1) are designed for testing for in-phase condition of three-phase systems.

Only electrically skilled or instructed persons are allowed to test for in-phase condition.

Phase comparators have to be tested for correct operation immediately before and after use.

Phase comparators without self-testing element have to be tested for correct operation by making contact with a part of the installation connected to operating voltage.

Testing for in-phase condition by means of a phase comparator is considered live working.

Phase comparators may only be used for the nominal voltage / nominal voltage range as indicated on the rating plate. The user may be at risk if the phase comparator is used for voltages other than indicated on the rating plate (incorrect indication, electric shock, arcing).

Phase comparators labelled "For indoor and outdoor installations" must not be used in wet weather conditions.

Phase comparators labelled "Also suitable for use in wet weather conditions" may be used in all weather conditions such as rain, snow, fog and dew.

Phase comparators in accordance with IEC/EN 61481-1 (DIN VDE 0682-431-1) are only suitable to a limited extent for use in factory assembled (type tested) installations.

Due to the restricted space in these installations, flashover may occur when inserting the test prod into the installation. The user of the phase comparator or the operator of the switchgear installation must contact the manufacturer of the type-tested installation to find out whether the phase comparator may be used in the installation.

Design of phase comparators

Phase comparators can be designed as **two-pole devices** (resistive phase comparators) in accordance with IEC/EN 61481-2 (DIN VDE 0682-431-2) or as **single-pole devices** (capacitive phase comparators) in accordance with IEC/EN 61481-1 (DIN VDE 0682-431-1).

The design of single-pole phase comparators is similar to that of capacitive voltage detectors. The functional principle of single-pole phase comparators is based on a microprocessor controlled electronic storage system. PHV and PHV I phase comparators are complete devices and are tested as a complete unit.

Single-pole phase comparators consist of a handle with hand guard, insulating element, indicator and test prod with contact electrode. Two-pole phase comparators additionally have a connecting cable.

The **insulating element** is the section of a phase comparator between the hand guard and the red ring. It ensures that the user maintains an adequate safety distance for safe operation.

The **test prod** with a contact electrode above the red ring allows to reach remote parts of the installation and to eliminate the influence of interference fields.

The **hand guard** provides a visible barrier between the handle and the insulating element and prevents the user from making contact with the insulating element.

The **red ring** indicates the end of the insulating element in the direction of the test electrode. This provides the user with a visible limit of contact with live parts in the installation. The insulating element situated between the red ring and the hand guard must not contact live parts, however, it may contact earthed parts.

The **test electrode** is the part of the phase comparator that is used to make contact with the part of the installation to be tested.

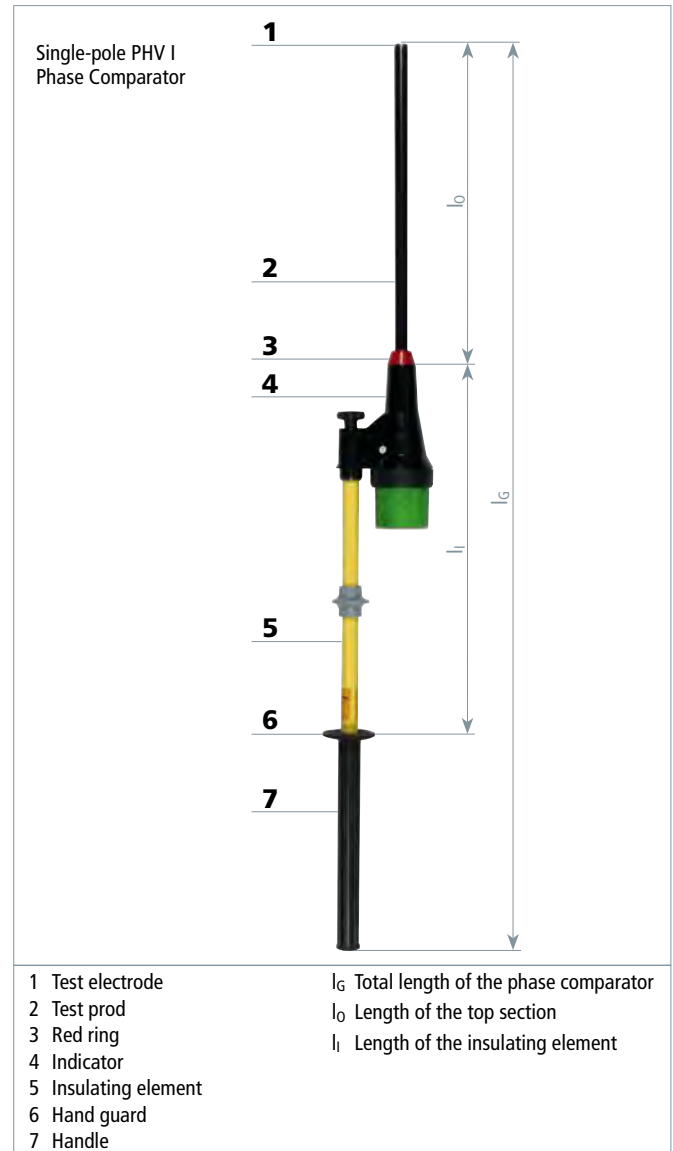

Storage Bags and Transport Cases



Cases: Sheet steel or plastic
Bags: Artificial leather or canvas

158

Maintenance Tests according to German regulations DGUV Vorschrift 3 (former BGV A3)



According to the German regulations DGUV Vorschrift 3 (former BGV A3), phase comparators have to be tested for compliance with the prescribed limits as stated in the Electrical Safety Rules. This test is performed in the high-voltage test laboratory of DEHN and includes

- measurement of the leakage current
- test for clear indication
- test for protection against bridging
- visual inspection, manual tests and measurements

The maintenance test is documented in a test report and on the device.

The test intervals depend on the operating conditions of the phase comparators, e.g. frequency of use, environmental conditions and transport. According to the German regulations DGUV Vorschrift 3, however, it is advisable to carry out a maintenance test **at least every 6 years**.

145

Single-pole PHV I Phase Comparator



Single-pole PHV I phase comparator used in a switchgear installation



Nominal voltages up to 36 kV / 50 Hz

Safe testing

- Reliable indication

General Information:

Standard	EN/IEC 61481-1 (DIN VDE 0682-431-1)
Temperature range	-25 °C ... +55 °C, climatic category N
For use in wet weather conditions	
For	Indoor and outdoor installations
Self-testing element	Yes
Material (test prod)	Plastic
Material (indicator)	Plastic, fully insulated
Material (insulating stick)	Glass-fibre reinforced polyester tube

Nominal Voltage Ranges up to 36 kV / 50 Hz



Type PHV1P ...	6 12	10 20	20 36
Part No.	759 706	759 712	759 736
Nominal voltage (UN)	6 ... 12 kV	10 ... 20 kV	20 ... 36 kV
Total length (lG)	1270 mm	1270 mm	1730 mm
Insertion depth (l0)	450 mm	450 mm	910 mm

Nominal Voltage Ranges up to 36 kV / 50 Hz, switchable



Type PHV1P ...	U 5 36
Part No.	759 716
Nominal voltage (UN)	5 ... 10 / 20 ... 36 kV
Total length (lG)	1730 mm
Insertion depth (l0)	910 mm

3. Verify that the Installation is dead – DEHNcap Voltage Detecting System

Product	Type	Nominal voltage U_N / Frequency f_N	Application, Indication	Page
DEHNcap/P Voltage Indicator				
	DEHNcap/P	up to 45 kV / 50 Hz	Passive indicator without batteries LED indication Can also be used as permanent voltage indicator	48
	DEHNcap/P Test Unit	230 V / 50 Hz	For testing for correct operation Plugs into 230 V socket outlets For HR and LRM indicators	
DEHNcap/A Voltage Indicator				
	DEHNcap/A	up to 45 kV / 50 Hz	Active voltage indicator Indication by two separate LEDs With self-testing element and battery monitoring device Automatic deactivation after use	49
DEHNcap/IT Interface Test Unit				
	DEHNcap/IT	up to 45 kV / 50 Hz	Active indicator for maintenance tests Indication by two separate LEDs With self-testing element and battery monitoring system Automatic deactivation after use	50
DEHNcap/PC Phase Comparator				
	DEHNcap/PC- LRM	up to 45 kV / 50 Hz	Active indicator for testing in-phase conditions Indication by three separate LEDs Can be used for HR test sockets with two HR-LRM test adapters Comparator detects zero crossings of the systems to be compared With battery monitoring device	51
DEHNcap HR-LRM Test Kit				
	DEHNcap HR-LRM Test Kit	up to 45 kV / 50 Hz	Fully equipped test kit	50
DEHNcap Test Adapter				
	Test Adapter			52
Storage Bags and Transport Cases				
			Cases: Sheet steel or plastic Bags: Artificial leather or canvas	158
Maintenance Tests according to German regulations DGUV Vorschrift 3 (former BGV A3)				
			According to the German regulations DGUV Vorschrift 3 (former BGV A3), capacitive voltage detecting systems have to be tested for compliance with the prescribed limits as stated in the Electrical Safety Rules. This test is performed in the high-voltage test laboratory of DEHN. The maintenance test is documented in a test report and on the device. The test intervals depend on the operating conditions of the capacitive voltage detecting systems, e.g. frequency of use, environmental conditions and transport. According to the German regulations DGUV Vorschrift 3, however, it is advisable to carry out a maintenance test at least every 6 years .	145

3. Verify that the Installation is dead – DEHNcap Voltage Detecting System

DEHNcap/P Voltage Indicator



DEHNcap/P passive voltage indicator used in an encapsulated switchgear installation.

- Nominal voltages up to 45 kV / 50 Hz
Easy verification of isolation from supply voltage
- Cost-effective

Test for correct operation

EN 50110-1 (DIN VDE 0105-100) requires that voltage indicators be tested for correct operation shortly before and after use.

Passive indicators without self-testing element must be tested for correct operation by plugging them into test sockets connected to operating voltage or into a test unit (DEHNcap/P test unit).

General Information:	
Standard	EN/IEC 61243-5 (DIN VDE 0682-415)
Temperature range	-25 °C ... +55 °C
Degree of protection	IP 66
Type of device	Voltage indicator
Use	Can also be used as permanent voltage indicator

DEHNcap/P-HR



Type SAG DCA P ...	HR GA
Part No.	767 101
Dimensions	40 x 48 x 35 mm
Plug spacing	19 mm
Indication threshold (HR system)	90 V
Input impedance (HR system)	36 MOhms

DEHNcap/P-LRM



Type SAG DCA P ...	LRM GA
Part No.	767 102
Dimensions	40 x 48 x 35 mm
Plug spacing	14 mm
Indication threshold (LRM system)	5 V
Input impedance (LRM system)	2 MOhms

Accessories for DEHNcap/P Voltage Indicator

Test unit for DEHNcap/P



Type	TG DCA
Part No.	767 110
Nominal voltage (U _N)	230 V
Frequency	50 Hz
Nominal capacity	500 mW
Max. short-circuit current at the test socket	Approx. 20 μA
Dimensions	43 x 75 x 35 mm

3. Verify that the Installation is dead – DEHNcap Voltage Detecting System

Electrical and mechanical interface requirements for pluggable HR, LR and LRM voltage detecting systems

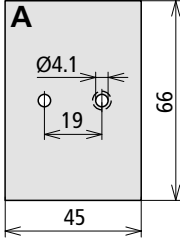
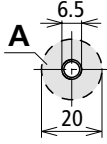
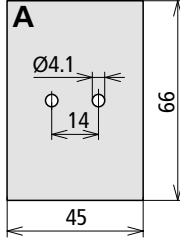
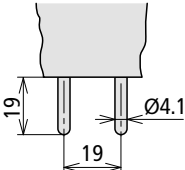
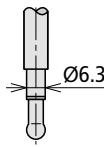
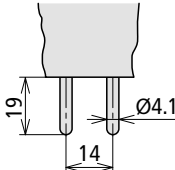
System description		HR high resistance	LR low resistance	LRM low resistance, modified
Input impedance of the indicator	X _c	36 MΩ	2 MΩ	2 MΩ
Electrical response conditions of the interface	I	2.5 μA	2.5 μA	2.5 μA
Electrical response conditions of the interface	U	90 V	5 V	5 V
Socket arrangement and minimum spare area A for indicator or plug				
Plug arrangement				

DEHNcap/A Voltage Indicator

Nominal voltages up to 45 kV / 50 Hz
Safe verification of isolation from supply voltage

- User-friendly
- Easy application

Self-testing element

DEHNcap/A electronic voltage indicators have an integrated self-testing element. By simply pressing the test button, the electronic circuit is tested for correct operation. The self-test is automatically performed as soon as the indicator is switched on. The voltage indicator is only operational if the test button is pressed, i.e. the function test was performed successfully.



Self-test of a DEHNcap/A voltage indicator

General Information:

Standard	EN/IEC 61243-5 (DIN VDE 0682-415)
Temperature range	- 25 °C ... + 55 °C
Field of application	Active voltage indicator for testing
Self-testing element	Yes

Type	SAG DCA A LRM
Part No.	767 112
Dimensions	120 x 60 x 25 mm
Plug spacing	14 mm
Type of plug	2 multilam plugs (Ø4 mm)
Indication threshold (LRM system)	5 V
Input impedance (LRM system)	2 MOhms



3. Verify that the Installation is dead – DEHNcap Voltage Detecting System

DEHNcap/IT Interface Test Unit



DEHNcap/IT interface test unit allows to carry out maintenance tests on coupling systems of switchgear installations according to IEC/EN 61243-5 (DIN VDE 0682-415).

Nominal voltages up to 45 kV / 50 Hz

Easy and safe testing

- User-friendly
- Easy handling

Self-testing element

The DEHNcap/IT interface test unit has an integrated self-testing element. By simply pressing the test button, the electronic circuit is tested for correct operation. The self-test is automatically performed as soon as the indicator is switched on. The interface test unit is only operational if the test button is pressed i.e. the function test was performed successfully.

General Information:

Standard	EN/IEC 61243-5 (DIN VDE 0682-415)
Temperature range	-25 °C ... +55 °C
Field of application	Active indicator for maintenance tests on coupling systems
Self-testing element	Yes



Type	SPG DCA IT LRM
Part No.	767 122
Dimensions	120 x 60 x 25 mm
Plug spacing	14 mm
Type of plug	2 multilam plugs (∅4 mm)
Input impedance (LRM system)	2 MOhms
Test threshold	3.2 µA

DEHNcap HR-LRM Test Kit



Nominal voltages up to 45 kV / 50 Hz

Easy and safe testing

- Complete test kit for universal use
- Easy operation

General Information:

Standard	EN/IEC 61243-5 (DIN VDE 0682-415)
Temperature range	-25 °C ... +55 °C

Kit in a plastic case for verifying that the installation is dead and testing the interface as well as for in-phase conditions in HR and LRM systems.



Type	PS DCA HR LRM
Part No.	767 150
Dimensions	395 x 295 x 105 mm

Kit includes:

Pos.	Part No.	Pos.	Part No.
1	1x 767 112	4	2x 767 133
2	1x 767 122	5	1x 767 107
3	1x 767 132		

For more detailed information on these products, see Accessories chapter

3. Verify that the Installation is dead – DEHNcap Voltage Detecting System

DEHNcap/PC-LRM Phase Comparator

Nominal voltages up to 45 kV / 50 Hz

Easy and safe testing

- User-friendly
- Easy handling

By attaching two optional HR-LRM adapters (Part No. 767 133), the DEHNcap/PC-LRM phase comparator can also be used for phase comparison in HR systems. DEHNcap/PC-LRM is designed as a universal phase comparator in accordance with EN/IEC 61243-5 (DIN VDE 0682-415) and detects zero crossings, but no voltage values.



DEHNcap/PC-LRM phase comparator with two HR-LRM test adapters used in an HR switchgear installation

General Information:	
Standard	EN/IEC 61243-5 (DIN VDE 0682-415)
Temperature range	-25 °C ... +55 °C
Design	Active indicator for testing for in-phase conditions on LRM test sockets
Field of application	For HR test sockets with two HR-LRM test adapters
Self-testing element	Yes

DEHNcap/PC-LRM

Type PV DCA PC ...	LRM
Part No.	767 132
Dimensions	145 x 85 x 32 mm
Measuring cables	3 measuring cables with multilam plug (Ø4 mm)
Length (measuring cable)	2000 mm
Indication threshold (LRM system)	5 V
Input impedance (LRM system)	2 MOhms



DEHNcap/PC-LRM Phase Comparator Kit

Phase comparator in an artificial leather bag (KLT 23 164).

Type PV DCA PC ...	LRM T
Part No.	767 139
Dimensions	145 x 85 x 32 mm
Measuring cables	3 measuring cables with multilam plug (Ø4 mm)
Length (measuring cable)	2000 mm
Indication threshold (LRM system)	5 V
Input impedance (LRM system)	2 MOhms



Accessories for DEHNcap/PC-LRM Phase Comparator

Artificial leather bag, empty

With carrying strap.

Type	KLT 23 16 4
Part No.	767 500
Suitable for	DCA PC
Dimensions	235 x 160 x 40 mm
Colour	Black ●



3. Verify that the Installation is dead – DEHNcap Voltage Detecting System

DEHNcap Test Adapter



Easy and safe testing

- Easy mechanical and electrical adaptation to HR, LR test sockets
- Measuring impedance for maintenance tests on coupling systems with suitable μA meter
- 4 mm safety plugs or sockets
- Energised HR plug, insulated

General Information:

Standard	EN/IEC 61243-5 (DIN VDE 0682-415)
Temperature range	- 25 °C ... + 55 °C

The HR-LRM test adapter for plugging an LRM indicator into a HR test socket.

HR-LRM Test Adapter

For electrical and mechanical adaptation of HR (HO) to LRM systems.

Used as a measuring impedance with $X_c = 36 \text{ MOhms}$ for maintenance tests on HR coupling systems (with suitable μA meter).



Type MA DCA ...	HR LRM
Part No.	767 133
Dimensions	90 x 50 x 30 mm
Plug spacing	19 mm
Socket spacing	14 mm
Type of plug	2 multilam plugs ($\varnothing 4 \text{ mm}$)
Type of test socket	2 sockets ($\varnothing 4 \text{ mm}$)









LR-LRM Test Adapter

For mechanical adaptation of LR (NO) to LRM systems.

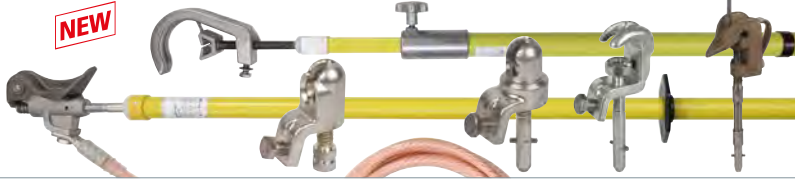

Type MA DCA ...	LR LRM
Part No.	767 136
Dimensions	100 x 50 x 30 mm
Plug spacing	jack, 6.3 mm
Socket spacing	14 mm
Type of plug	1 jack
Type of test socket	2 sockets ($\varnothing 4 \text{ mm}$)

4. Carry out Earthing and Short-Circuiting – EaS Devices

Product	Type / Use	Page
Fixed Phase and Earthing Points		
		57
EaS Cables, unequipped		
	One-pole to five-pole	64
Phase Connecting Elements		
	For switchgear installations	69
	For overhead lines	71
	For railway applications	74
Earth Connecting Elements		
	Earthing kit	75
	For switchgear installations and overhead lines	76
	For railway applications	79
Earthing Sticks		
	For switchgear installations (single-part and two-part)	80
	For overhead lines (telescopic and multi-part)	82
EaS Devices, Short-Circuiting Bars		
		86
		
Storage Bags and Transport Cases		
	Cases: Sheet steel or plastic Bags: Artificial leather or canvas	158
Maintenance Tests according to German regulations DGUV Vorschrift 3 (former BGV A3)		
	<p>According to the German regulations DGUV Vorschrift 3 (former BGV A3), §5 section 1 it shall be checked whether the equipment, such as earthing and short-circuiting devices, is in good order and condition at certain intervals. The intervals must be chosen so that the defects to be expected are detected in due time. These tests are performed at DEHN or on site in compliance with a new measuring method*) and includes</p> <ul style="list-style-type: none"> – visual inspection for signs of damage or defect – measurement of total resistance at the stationary earthing and short-circuiting device (static test) – measurement of the relative resistance change in the cable and at the connecting points of the portable earthing and short-circuiting device (dynamic test) <p>The maintenance test is documented in a test report and on the device.</p> <p>*) This measuring method has been developed on behalf of GB ETEM at the Dresden University of Applied Sciences, Germany.</p>	145

4. Carry out Earthing and Short-Circuiting – EaS Devices

Earthing and Short-Circuiting Devices

Earthing and short-circuiting at the work location is a key element of the five safety rules. This measure ensures that the installation is de-energised when working on electrical equipment even in case of interference voltages, atmospheric surges or accidental reconnection.

Isolation from supply voltage must be verified at the point of installation immediately before portable earthing and short-circuiting equipment is installed.

When installing earthing and short-circuiting devices, the earthing cable always has to be connected to the earthing system first to ensure that residual or interference voltages are discharged.

Portable earthing and short-circuiting equipment according to IEC/EN 61230 (DIN VDE 0683-100) is a hand-held device used to approach fixed connection points of parts of an electrical installation for earthing and short-circuiting purposes (according to EN 50110-1 (DIN VDE 0105-100), section 6.2.4) and for connection with the fixed connection points without guide slots, bushings or guide rails. It consists of an earthing and short-circuiting device (EaS device) and an earthing stick.

The purpose of **earthing and short-circuiting devices** is to earth and short-circuit electrical conductors. They consist of an earthing and short-circuiting device. The **earthing device** connects the earthing system with a short-circuiting device or with the equipment to be earthed. It consists of an earth clamp (1) and an earthing cable (4).

The **short-circuiting device** connects the phase conductors that have to be short-circuited. It consists of clamps (1+2), short-circuiting cables or bars (3) and connecting clusters (5), if required.

The **short-circuiting bar** is a rigid short-circuiting device.

Connecting clusters connect the short-circuiting cables with each other and with the earthing cable or the short-circuiting bar with the earthing cable.

Connecting clamps connect the earthing and short-circuiting cables or bars to the earthing system either directly or via connecting links such as cable lugs and to parts of the installation via fixed connection points, if required.

Fixed connection points are parts of the installation to which earthing and short-circuiting devices are connected (e.g. conductors, bars, fixed ball points, cylinder bolts, clamps etc.). Maximum short-circuit strength can be achieved by connecting the fixed ball point with the ball head cap of the earthing and short-circuiting device.

An **earthing stick** is a hand-held insulating stick for approaching clamps of earthing and short-circuiting devices to parts of electrical installations for earthing and short-circuiting purposes. It consists of an insulating element, black ring, handle and coupling for attaching clamps. Earthing sticks are selected according to the **weight** of the earthing and short-circuiting devices to be connected (see "max. load on operating head in kg").

The **insulating element** is the part of the earthing stick between the black ring and the end of the earthing stick in the direction of the clamp. It ensures that the user maintains the required safe distance and provides sufficient insulation. The insulating element l_I must have a minimum length of 500 mm in installations exceeding 1 kV.

A complete earthing and short-circuiting device according to IEC/EN 61230 (DIN VDE 0683-100) includes, for example:

- Fixed point / Fixed ball point
- Single-pole or three-pole earthing and short-circuiting device or short-circuiting bar
- Fixed earthing point
- Earthing stick

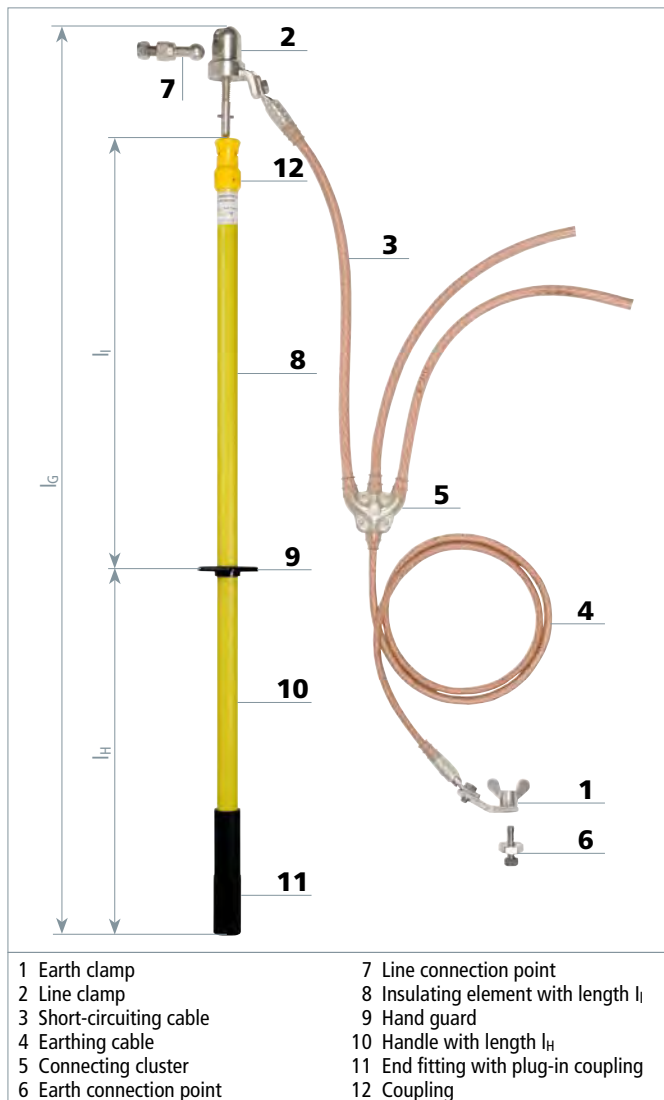

Portable earthing and short-circuiting equipment

Earthing and short-circuiting devices as well as the fixed ball and earthing points must be rated to withstand the **short-circuit current conditions** expected on site. The required cable cross-section depends on the maximum short-circuit current (I_k in A) and the maximum short-circuit time (T_k in s).

Note:

In the event of a short-circuit, the short-circuit current will flow through the short-circuiting device. However, this is different for earthing devices as they do not conduct short-circuit currents and can therefore be rated for lower values.

4. Carry out Earthing and Short-Circuiting – EaS Devices

Cable cross-section:

For short-circuiting cables of our threepole earthing and short-circuiting devices with cross-sections of 50 mm² and higher, the cross-section of the earthing cable can be reduced according to the following table.

These earthing and short-circuiting devices with reduced earthing cable cross-sections can be used for all non-solidly earthed neutral systems (e.g. compensated systems with impedance neutral earthing). For solidly earthed neutral systems, the earthing and short-circuiting cables must have the same cross-sections.

The current carrying capacity of the short-circuiting cable and the short-circuiting bar depends on the material, the cross-section (A) and the short-circuit time (T_k).

Calculations were based on the most critical case, i.e. an off-generator short circuit (μ = 1) and a maximum d.c. components (χ = 1.8) with I_k^{''} being the maximum initial short-circuit alternating current, which, according to DIN VDE 0102, is equal to the permanent short-circuit current I_k and the breaking current I_a:

$$I_k'' = I_k = I_a$$

The diagrams or the table help to determine the required cable or busbar cross-sections of short-circuiting devices according to the short-circuit current and the short-circuit time of an installation.

Cable Cross-Section	
Short-circuiting cable	Earthing cable
16 mm ²	16 mm ²
25 mm ²	25 mm ²
35 mm ²	35 mm ²
50 mm ²	25 mm ²
70 mm ²	35 mm ²
95 mm ²	35 mm ²
120 mm ²	50 mm ²
150 mm ²	50 mm ²

Current carrying capacity of copper short-circuiting cables for use in a.c. and three-phase installations

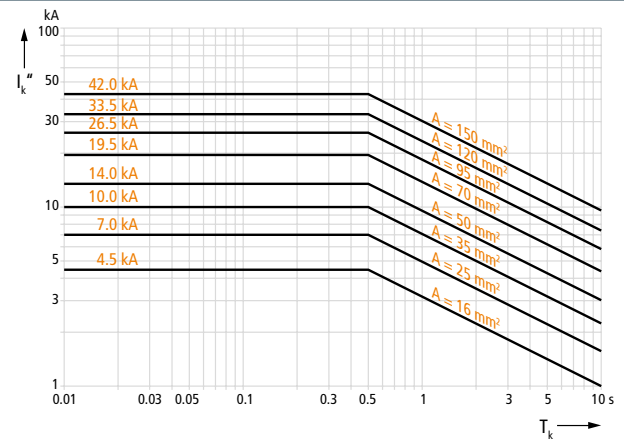

Initial cable temperature 20 °C

Final cable temperature 250 °C

$$A = 5.07 I_k'' \sqrt{T_k} \quad \text{for } T_k \geq 0.5 \text{ s}$$

Where:

A Cable cross-section in mm²

I_k^{''} Maximum initial short-circuit alternating current in kA according to DIN VDE 0102

T_k Short-circuit time in s

Current carrying capacity of copper short-circuiting cables for use in d.c. installations

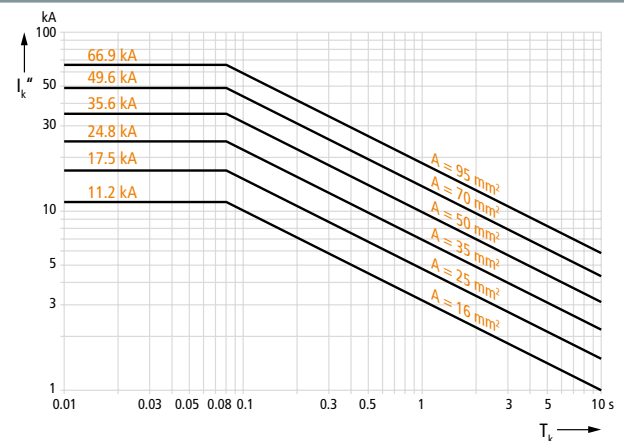

Initial cable temperature 20 °C

Final cable temperature 250 °C

$$A = 5.07 I_k'' \sqrt{T_k} \quad \text{for } T_k \geq 0.08 \text{ s}$$

Where:

A Cable cross-section in mm²

I_k^{''} Maximum initial short-circuit alternating current in kA according to DIN VDE 0102

T_k Short-circuit time in s

Current carrying capacity of copper short-circuiting cables for use on overhead contact lines of electric railways

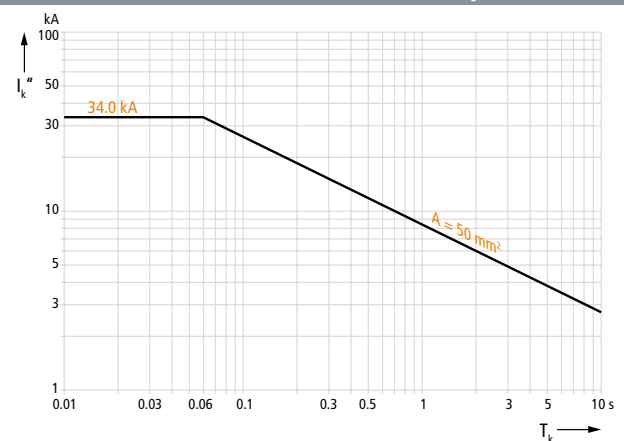

$$A = 6.0 I_k'' \sqrt{T_k} \quad \text{for } T_k \geq 0.06 \text{ s}$$

Where:

A Cable cross-section in mm²

I_k^{''} Maximum initial short-circuit alternating current in kA according to DIN VDE 0102

T_k Short-circuit time in s

4. Carry out Earthing and Short-Circuiting – EaS Devices

Calculation example:

Known: Mains breaking capacity S_a
Short-circuit time T_k

Unknown: Required cable or bar cross-section A.

The calculation is based on an off-generator short-circuit.

$$\text{Three-phase current} \quad I_k'' = I_k = I_a = \frac{S_a}{\sqrt{3} \cdot U_N}$$

$$\text{Single-phase alternating current} \quad I_k'' = I_k = I_a = \frac{S_a}{U_N}$$

The required cable or bar cross-section can now be calculated based on I_k'' of the above equations or can be taken from the diagrams. The permissible current carrying capacity of an earthing and short-circuiting device is based on the cross-section printed on the short-circuiting cables or bars.

Note:

- Earthing and short-circuiting devices can only be loaded once with the permissible short-circuit currents depending on the short-circuit time.
- Short-circuiting cables of multi-pole earthing and short-circuiting devices must have the same cross-sections.
- Cable lengths of earthing and short-circuiting devices should be at least 120% of the distance between two fixed connection points. They should be as short as possible as the cables move violently during a short-circuit.
- When connecting earthing and short-circuiting devices in parallel with cables for achieving certain total cable cross-sections, the following conditions must be fulfilled:
 1. Identical cable lengths and cross-sections,
 2. Identical connecting clamps and fixed connection points
 3. Installing the devices directly next to each other, with parallel arrangement of cables,
 4. The current carrying capacity per cable must be reduced to 75% of the current carrying capacity of the cable cross-section.

Remark:

If it is ensured that earthing and short-circuiting devices connected in parallel are loaded with short-circuit currents only once (no interruption of the short circuit), the devices may be exposed to the full load. Generally, this applies to installations with nominal voltages above 110 kV.

Table:

Cable cross-section of the earthing and short-circuiting device depending on the maximum short-circuit I_k and maximum short-circuit time T_k

- For copper (Cu)

Cross-section of the copper cable	Max. short-circuit current I_k at a duration of				
	10 s	5 s	2 s	1 s *)	≤ 0.5 s *)
16 mm ²	1 000 A	1 400 A	2 200 A	3 200 A	4 500 A
25 mm ²	1 600 A	2 200 A	3 500 A	4 900 A	7 000 A
35 mm ²	2 200 A	3 100 A	4 900 A	6 900 A	10 000 A
50 mm ²	3 100 A	4 400 A	7 000 A	9 900 A	14 000 A
70 mm ²	4 400 A	6 200 A	9 800 A	13 800 A	19 500 A
95 mm ²	5 900 A	8 400 A	13 200 A	18 700 A	26 500 A
120 mm ²	7 500 A	10 600 A	16 700 A	23 700 A	33 500 A
150 mm ²	9 400 A	13 200 A	20 900 A	29 600 A	42 000 A

*) catalogue data

- For aluminium (Al)

Cross-section of the aluminium cable	Max. short-circuit current I_k at a duration of				
	10 s	5 s	2 s	1 s *)	≤ 0.5 s *)
35 mm ²	1 400 A	2 000 A	3 200 A	4 600 A	6 500 A
50 mm ²	2 100 A	2 900 A	4 600 A	6 600 A	9 300 A
70 mm ²	2 900 A	4 100 A	6 500 A	9 200 A	13 000 A

*) catalogue data

4. Carry out Earthing and Short-Circuiting – EaS Devices

Fixed Ball Points

Ø20 or 25 mm

- Suitable for fixing cable lugs or connecting busbars in accordance with DIN 43673-1
- Self-locking nut
- M12 or M16 non-cutting formed female thread
- M12 or M16 threaded pin



Straight fixed ball point mounted on a busbar

General Information:	
Standard	EN/IEC 61230 (DIN VDE 0683-100) and based on DIN 48088-1
Material (fixed ball point)	E-Cu/gal Sn
Material (threaded pin)	StSt A2-70
Hexagon nut	DIN 985-M12-8 / gal Zn; DIN 985-M16-8 / gal Zn
Tightening torque	M10: 30-40 Nm; M12: 50-65 Nm; M16: 100-110 Nm

Angled with Terminal Lug

Type KFP ...	20 S AL 12	25 S AL 12
Part No.	706 300	756 300
Fixed ball point Ø	20 mm	25 mm
Bore Ø	12.5 mm	12.5 mm
Dimensions	45 x 30 x 9 mm	50 x 30 x 9 mm
Max. cable cross-section Cu	50 mm ²	95 mm ²
Max. short-circuit current I _k 0.5 s	14.0 kA	26.5 kA
Max. short-circuit current I _k 1 s	9.9 kA	18.7 kA



Straight with Threaded Pin and Self-locking Nut

Type KFP ...	20 M12 35 SSM	20 M12 45 SN7078	20 M16 45 SSM
Part No.	754 235	754 238	754 645
Fixed ball point Ø	20 mm	20 mm	20 mm
Dimensions	M12 x 35 mm	M12 x 45 mm	M16 x 45 mm
Wrench size	24 mm	24 mm	24 mm
Max. cable cross-section Cu	120 mm ²	120 mm ²	120 mm ²
Max. short-circuit current I _k 0.5 s	33.5 kA	33.5 kA	33.5 kA
Max. short-circuit current I _k 1 s	23.7 kA	23.7 kA	23.7 kA



Type KFP ...	25 M12 25 SSM	25 M12 45 SSM	25 M16 45 SSM
Part No.	755 225	755 245	755 645
Fixed ball point Ø	25 mm	25 mm	25 mm
Dimensions	M12 x 25 mm	M12 x 45 mm	M16 x 45 mm
Wrench size	27 mm	27 mm	27 mm
Max. cable cross-section Cu	150 mm ²	150 mm ²	150 mm ²
Max. short-circuit current I _k 0.5 s	42.0 kA	42.0 kA	42.0 kA
Max. short-circuit current I _k 1 s	29.6 kA	29.6 kA	29.6 kA

Straight with Female Thread

Type KFP ...	20 M10	20 M12	20 M16
Part No.	754 205	754 200	754 600
Fixed ball point Ø	20 mm	20 mm	20 mm
Dimensions	M10	M12	M16
Wrench size	24 mm	24 mm	24 mm
Max. cable cross-section Cu	120 mm ²	120 mm ²	120 mm ²
Max. short-circuit current I _k 0.5 s	33.5 kA	33.5 kA	33.5 kA
Max. short-circuit current I _k 1 s	23.7 kA	23.7 kA	23.7 kA



Type KFP ...	25 M12	25 M16
Part No.	755 200	755 600
Fixed ball point Ø	25 mm	25 mm
Dimensions	M12	M16
Wrench size	27 mm	27 mm
Max. cable cross-section Cu	150 mm ²	150 mm ²
Max. short-circuit current I _k 0.5 s	42.0 kA	42.0 kA
Max. short-circuit current I _k 1 s	29.6 kA	29.6 kA

4. Carry out Earthing and Short-Circuiting – EaS Devices

Straight with Threaded Pin, Nut and Washer



Type KFP ...	25 M16 25 SKM	25 M12 35 SKM	25 M16 45 SKM
Part No.	755 626	755 627	755 646
Fixed ball point Ø	25 mm	25 mm	25 mm
Dimensions	M16 x 25 mm	M12 x 35 mm	M16 x 45 mm
Max. short-circuit current I_k 0.06 s	34.0 kA	34.0 kA	34.0 kA
DB drawing No.	3 Ebgw 01.63	3 Ebgw 01.63	3 Ebgw 01.63
DB material No.	157 541	622 014	157 542

Straight with Threaded Pin



Type KFP ...	25 M16 25
Part No.	755 636
Fixed ball point Ø	25 mm
Dimensions	M16 x 25 mm
Max. short-circuit current I_k 0.06 s	34.0 kA
DB drawing No.	3 Ebgw 01.63
DB material No.	609 426

Straight with Round Conductor Half Shell for Round Copper Conductors



General Information:	
Fixed ball point Ø	25 mm
Max. cable cross-section Cu	95 mm ²
Max. short-circuit current I_k 0.5 s	26.5 kA
Max. short-circuit current I_k 1 s	18.7 kA

Type KFP ...	25 RL 10	25 RL 12	25 RL 14
Part No.	725 010	725 012	725 014
For round conductor Ød	10 mm	12 mm	14 mm

Type KFP ...	25 RL 16	25 RL 18	25 RL 20
Part No.	725 016	725 018	725 020
For round conductor Ød	16 mm	18 mm	20 mm

45° angled with Threaded Pin and Self-locking Nut



Type KFP ...	20 W45M12 SN7024	20 W45 M12 35SSM	20 W45 M16 45SSM
Part No.	706 239	706 235	706 645
Fixed ball point Ø	20 mm	20 mm	20 mm
Dimensions	M12 x 30 mm	M12 x 35 mm	M16 x 45 mm
Wrench size	24 mm	24 mm	24 mm
Max. cable cross-section Cu	70 mm ²	70 mm ²	70 mm ²
Max. short-circuit current I_k 0.5 s	19.5 kA	19.5 kA	19.5 kA
Max. short-circuit current I_k 1 s	13.8 kA	13.8 kA	13.8 kA

Type KFP ...	25 W45 M12 45SSM	25 W45 M16 45SSM
Part No.	756 245	756 645
Fixed ball point Ø	25 mm	25 mm
Dimensions	M12 x 45 mm	M16 x 45 mm
Wrench size	27 mm	27 mm
Max. cable cross-section Cu	95 mm ²	95 mm ²
Max. short-circuit current I_k 0.5 s	26.5 kA	26.5 kA
Max. short-circuit current I_k 1 s	18.7 kA	18.7 kA

45° angled with Female Thread



Type KFP ...	20 W45 M12	20 W45 M16	25 W45 M12	25 W45 M16
Part No.	706 200	706 600	756 200	756 600
Fixed ball point Ø	20 mm	20 mm	25 mm	25 mm
Dimensions	M12	M16	M12	M16
Wrench size	24 mm	24 mm	27 mm	27 mm
Max. cable cross-section Cu	70 mm ²	70 mm ²	95 mm ²	95 mm ²
Max. short-circuit current I_k 0.5 s	19.5 kA	19.5 kA	26.5 kA	26.5 kA
Max. short-circuit current I_k 1 s	13.8 kA	13.8 kA	18.7 kA	18.7 kA

4. Carry out Earthing and Short-Circuiting – EaS Devices

90° angled with Threaded Pin and Self-locking Nut

Type KFP ...	20 W90 M12 35SSM	20 W90 M16 45SSM	25 W90 M12 45SSM	25 W90 M16 45SSM
Part No.	707 235	707 645	757 245	757 645
Fixed ball point Ø	20 mm	20 mm	25 mm	25 mm
Dimensions	M12 x 35 mm	M16 x 45 mm	M12 x 45 mm	M16 x 45 mm
Wrench size	24 mm	24 mm	27 mm	27 mm
Max. cable cross-section Cu	70 mm ²	70 mm ²	95 mm ²	95 mm ²
Max. short-circuit current I _k 0.5 s	19.5 kA	19.5 kA	26.5 kA	26.5 kA
Max. short-circuit current I _k 1 s	13.8 kA	13.8 kA	18.7 kA	18.7 kA



90° angled with Female Thread

Type KFP ...	20 W90 M12	20 W90 M16	25 W90 M12	25 W90 M16
Part No.	707 200	707 600	757 200	757 600
Fixed ball point Ø	20 mm	20 mm	25 mm	25 mm
Dimensions	M12	M16	M12	M16
Wrench size	24 mm	24 mm	27 mm	27 mm
Max. cable cross-section Cu	70 mm ²	70 mm ²	95 mm ²	95 mm ²
Max. short-circuit current I _k 0.5 s	19.5 kA	19.5 kA	26.5 kA	26.5 kA
Max. short-circuit current I _k 1 s	13.8 kA	13.8 kA	18.7 kA	18.7 kA



Fastening Material

For fixed ball and earthing points

- Hexagon bolt for fixing busbar connections according to DIN 43673-1
- Resilient pressure plate for installing M12 or M16 fixed points on aluminium busbars

General Information:	
Standard (hexagon bolts)	In accordance with DIN 933 and DIN 43673-1
Standard (spring washers)	In accordance with DIN 128
Standard (washers)	In accordance with DIN 125

Determination of the bolt length l
 l = Bolt length
 B = Thickness of the busbar
 s = Thickness of the spring washer and washer
 l (mm) = $B + s + 13 \dots 16$

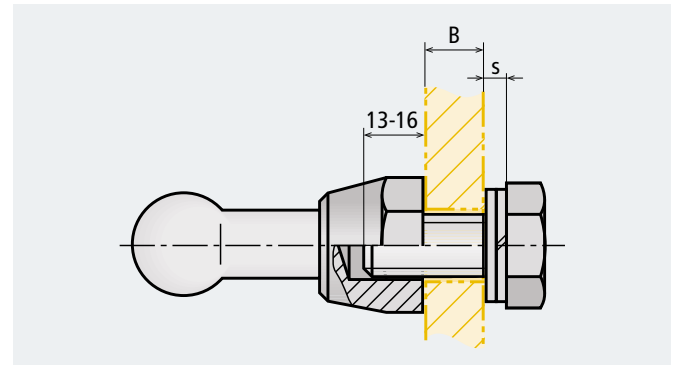

Determination of the required bolt length

Hexagon Bolts

Type	SKS M10X30 V2A	SKS M12X25 V2A	SKS M12X30 V2A	SKS M12X35 V2A	SKS M16X30 V2A
Part No.	561 924	561 925	561 930	561 935	561 931
Dimensions	M10 x 30 mm	M12 x 25 mm	M12 x 30 mm	M12 x 35 mm	M16 x 30 mm
Material	StSt A2-70	StSt A2-70	StSt A2-70	StSt A2-70	StSt A2-70
Tightening torque	80 Nm	80 Nm	80 Nm	80 Nm	150 Nm



Spring Washers

Type	FR A10 V2A	FR A12 V2A	FR A16 V2A
Part No.	524 910	524 912	524 913
Dimensions	A10 (s = 2.2) mm	A12 (s = 2.4) mm	A16 (s = 2.8) mm
Material	StSt A2-70	StSt A2-70	StSt A2-70



Washers

Type	SCH A10.5 V4A	SCH A13 V4A	SCH A17 V2A
Part No.	525 910	525 912	525 916
Dimensions	A10.5 (s = 2.0) mm	A13 (s = 2.4) mm	A17 (s = 3.0) mm
Material	StSt A4-70	StSt A4-70	StSt A2-70



Resilient Square Pressure Plate

For reliable contact and permanent installation of fixed ball points on aluminium busbars. Pressure plates must be shimmed on both sides of the busbar.

Type	DP 40 40 B13 AL	DP 50 50 B17 AL
Part No.	525 001	525 002
Dimensions	M12, 40 x 40 x 6 mm	M16, 50 x 50 x 8 mm
Material	Highly resistant Al alloy	Highly resistant Al alloy



4. Carry out Earthing and Short-Circuiting – EaS Devices

Fixed Earthing Points



Fixed earthing point with ring groove and earth bushing

Ring groove and connecting elements

- For connecting earth bushings or earth connecting plates in accordance with DIN 48088-2
- Welding-type or bolted-type connector for connecting earth connectors with wing nut or wing bolt on the earth cable end
- Connectors with M12 or M16 threaded pin
- M12 or M16 female thread

General Information:

Standard	EN/IEC 61230 (DIN VDE 0683-100) and DIN 48088-2 and -5
Tightening torque	M12: 80 Nm; M16: 150 Nm



Ring Groove Fixed Point with Threaded Pin and Nut

Type	EFP 16 RN M12 35 SSM	EFP 16 RN M16 45 SSM
Part No.	790 251	790 261
Dimensions	M12 x 35 mm	M16 x 45 mm
Diameter	16 mm	16 mm
Wrench size	22 mm	22 mm
Max. cable cross-section Cu	150 mm ²	150 mm ²
Max. short-circuit current I _k 0.5 s	42.0 ^{*)} kA	42.0 ^{*)} kA
Max. short-circuit current I _k 1 s	29.6 ^{*)} kA	29.6 ^{*)} kA
Material	Brass (CuNi2Si) / gal Sn	Brass (CuNi2Si) / gal Sn
Material (threaded pin)	StSt A2-70	StSt A2-70
Material (nut)	DIN 985-M12-8 / gal Zn	DIN 985-M16-8 / gal Zn

^{*)} For earthing and short-circuiting devices with cable lengths > 4000 mm: 26.5 kA / 0.5 s (18.7 kA / 1 s)



Ring Groove Fixed Point with Female Thread

Type	EFP 16 RN M12	EFP 16 RN M16
Part No.	790 250	790 260
Dimensions	M12	M16
Diameter	16 mm	16 mm
Wrench size	22 mm	22 mm
Max. cable cross-section Cu	150 mm ²	150 mm ²
Max. short-circuit current I _k 0.5 s	42.0 ^{*)} kA	42.0 ^{*)} kA
Max. short-circuit current I _k 1 s	29.6 ^{*)} kA	29.6 ^{*)} kA
Material	Brass (CuNi2Si) / gal Sn	Brass (CuNi2Si) / gal Sn

^{*)} For earthing and short-circuiting devices with cable lengths > 4000 mm: 26.5 kA / 0.5 s (18.7 kA / 1 s)



Weld-on Connector with Threaded Pin

Type	AS SCHW M12 25	AS SCHW M16 30
Part No.	705 501	755 501
Dimensions	M12 x 25 mm	M16 x 30 mm
Material	St/gal Zn	St/gal Zn



Weld-on Connector with Female Thread

Type	AS SCHW M12	AS SCHW M16
Part No.	336 020	336 025
Dimensions	M12	M16
Material	St/gal Zn	St/gal Zn

4. Carry out Earthing and Short-Circuiting – EaS Devices

Bolted-type Connector with Female Thread

Type	AS SCHR M12 M12 40
Part No.	705 504
Dimensions	M12 / M12 x 40 mm
Wrench size	27 mm
Max. cable cross-section Cu	150 mm ²
Max. short-circuit current I_k 0.5 s	42.0 kA
Max. short-circuit current I_k 1 s	29.6 kA
Material	Copper alloy/gal Sn



Bolted-type Connector with Threaded Pin and Separate Hexagon Nut

Type	AS SCHR M12 55	AS SCHR M16 65
Part No.	705 500	750 500
Dimensions	M12 x 55 mm	M16 x 65 mm
Wrench size	32 mm	41 mm
Max. cable cross-section Cu	150 mm ²	150 mm ²
Max. short-circuit current I_k 0.5 s	42.0 kA	42.0 kA
Max. short-circuit current I_k 1 s	29.6 kA	29.6 kA
Material (threaded pin)	StSt	StSt
Material (nut)	Copper alloy/gal Sn / St/tZn	Copper alloy/gal Sn / St/tZn



Bolted-type Connector for Converting from M12 to M16 Threaded Pin

Type	AS SCHR M16 55 M12
Part No.	705 510
Dimensions	M12 x 20 mm / M16 x 55 mm
Wrench size	41 mm
Max. cable cross-section Cu	150 mm ²
Max. short-circuit current I_k 0.5 s	42.0 kA
Max. short-circuit current I_k 1 s	29.6 kA
Material (threaded pin)	StSt
Material (nut)	Copper alloy/gal Sn



4. Carry out Earthing and Short-Circuiting – EaS Devices

Earth Connecting Plates



Earth connecting plate with fixed ball points and ball head cap with plastic handle

- Connecting plate with high short-circuit current carrying capacity
- Single-pole connection of the phase arms
- For connecting single-pole earthing and short-circuiting devices to transformers of overhead line masts or to fuse holders
- For fixed ball points (Ø20 mm, Ø25 mm) or ring groove pins (Ø16 mm)

General Information:

Standard	EN/IEC 61230 (DIN VDE 0683-100) and fixed points in accordance with DIN 48088-1
Material (plate)	Aluminium
Material (terminal lug)	4 mm: Cu / gal Sn; 6 mm: St / tZn
Material (fixed point)	E-Cu / brass (CuNi2Si) / gal Sn



With three Fixed Ball Points and Ball Head Cap

Type	EAPA 3 KFP 20 KKH	EAPA 3 KFP 25 KKH
Part No.	728 620	728 625
Fixed point Ø	20 mm	25 mm
Max. cable cross-section Cu	120 mm ²	150 mm ²
Max. short-circuit current I _k 0.5 s	33.5 kA	42.0 kA
Max. short-circuit current I _k 1 s	23.7 kA	29.6 kA

With three Fixed Ball Points

For mounting on earth connecting clamps with anti-rotation element (PK1).



Type	EAPA 3 KFP 20 B13	EAPA 3 KFP 25 B13
Part No.	728 522	728 526
Fixed point Ø	20 mm	25 mm
Max. cable cross-section Cu	120 mm ²	150 mm ²
Max. short-circuit current I _k 0.5 s	33.5 kA	42.0 kA
Max. short-circuit current I _k 1 s	23.7 kA	29.6 kA

With three Ring Groove Fixed Points and Earth Bushing



Type	EAPA 3 RN 16 EAB
Part No.	728 516
Fixed point Ø	16 mm
Max. cable cross-section Cu	95 mm ²
Max. short-circuit current I _k 0.5 s	26.5 kA
Max. short-circuit current I _k 1 s	18.7 kA

With three Ring Groove Fixed Points

For mounting on earth connecting clamps with anti-rotation element (PK1).



Type	EAPA 3 RN 16 B13
Part No.	728 506
Fixed point Ø	16 mm
Max. cable cross-section Cu	95 mm ²
Max. short-circuit current I _k 0.5 s	26.5 kA
Max. short-circuit current I _k 1 s	18.7 kA

4. Carry out Earthing and Short-Circuiting – EaS Devices

With two Fixed Ball Points and Ball Head Cap

With adjustable ball head cap (Ø25 mm) and plastic handle.

For connecting two single-pole earthing and short-circuiting devices to one fixed ball point (Ø25 mm).



Type	EAP 2 25 KKH HG
Part No.	728 501
Fixed point Ø	25 mm
DB drawing No.	3 Ebgw 01.66
DB material No.	157 540



Terminal Lug with one Fixed Ball Point

For connection to a fuse holder.



Type	EAP 25 SIT US OL
Part No.	728 503
Fixed point Ø	25 mm
DB drawing No.	4 Ebgw 01.60
DB material No.	157 545



Terminal Lug with two Fixed Ball Points

For connection to the mast.



Type	EAP 2 25 MA US OL
Part No.	728 502
Fixed point Ø	25 mm
DB drawing No.	3 Ebgw 01.61
DB material No.	157 548



4. Carry out Earthing and Short-Circuiting – EaS Devices

Earthing and Short-Circuiting Cables, unequipped

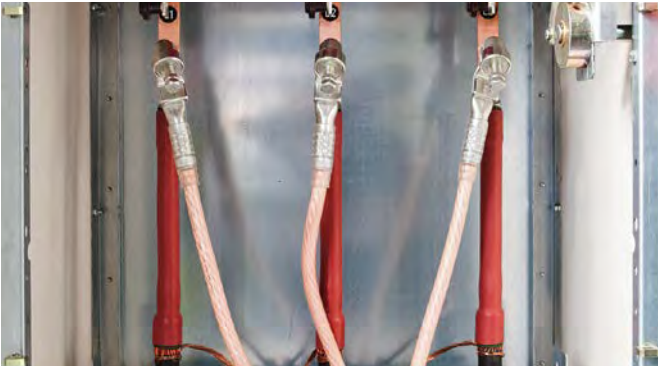

Equipped three-pole earthing and short-circuiting device in a switchgear installation

- To be equipped with connecting components
- Transparent sheath
- Waterproof and plastic-sheathed cable entries and node unit, additional anti-kink protection
- Standard anti-rotation crimped cable lugs (type PK1)
- Other cable lengths and crimped cable lugs can be selected online via the earthing and short-circuiting configurator
- Earthing and short-circuiting devices can be configured online via the earthing and short-circuiting configurator

General Information:	
Standard	EN/IEC 61138 (DIN VDE 0283-3) and EN/IEC 61230 (DIN VDE 0683-100)
Temperature range	- 25 °C ... +55 °C
Material (cable)	Al, flexible; E-Cu, extra finely stranded and highly flexible
Material (sheath)	Thermoplastic polymer (flexible PVC compound YM2)
Hole (cable lug)	Ø12.5 mm

 EaS Configurator:
www.dehn.de/en/euk



Crimped cable lugs, type PK1:
Standard anti-rotation cable lug with cut-out.



Crimped cable lugs, type PK2:
Cable lugs without cut-out for connecting parts from other manufacturers are available on request.



Crimped cable lugs, type PK3:
Hook-type cable lugs up to cable cross-sections of 35 mm² are available on request.

Single-pole Earthing and Short-circuiting Cables, aluminium version



Type	EKV1+0 35 VGHVBP5	EKV1+0 50 VKVBG8W	EKV1+0 70 VVXDACJ
Variant No.	VGHVBP5	VKVBG8W	VVXDACJ
Cable cross-section	35 mm ²	50 mm ²	70 mm ²
Material	Al	Al	Al
Max. short-circuit current I _k 0.5 s	6.5 kA	9.3 kA	13.0 kA
Max. short-circuit current I _k 1 s	4.6 kA	6.6 kA	9.2 kA
Crimped cable lug	PK1	PK1	PK1

Attention: Please state the relevant Variant No. when ordering.

4. Carry out Earthing and Short-Circuiting – EaS Devices

Single-pole Earthing and Short-Circuiting Cables, copper version



General Information:

Material	Cu
Crimped cable lug	PK1

Type	EKV1+0 16 V4YPRGE	EKV1+0 25 VSY71K4	EKV1+0 35 V9JF26K	EKV1+0 50 VRJG23Y
Variant No.	V4YPRGE	VSY71K4	V9JF26K	VRJG23Y
Cable cross-section	16 mm ²	25 mm ²	35 mm ²	50 mm ²
Max. short-circuit current I_k 0.5 s	4.5 kA	7.0 kA	10.0 kA	14.0 kA
Max. short-circuit current I_k 1 s	3.2 kA	4.9 kA	6.9 kA	9.9 kA

Type	EKV1+0 70 VPZBBSL	EKV1+0 95 VZC3FST	EKV1+0 120 V797FE6	EKV1+0 150 VB53TC9
Variant No.	VPZBBSL	VZC3FST	V797FE6	VB53TC9
Cable cross-section	70 mm ²	95 mm ²	120 mm ²	150 mm ²
Max. short-circuit current I_k 0.5 s	19.5 kA	26.5 kA	33.5 kA	42.0 kA
Max. short-circuit current I_k 1 s	13.8 kA	18.7 kA	23.7 kA	29.6 kA

Attention: Please state the relevant Variant No. when ordering.

Two-pole Earthing and Short-Circuiting Cables, copper version

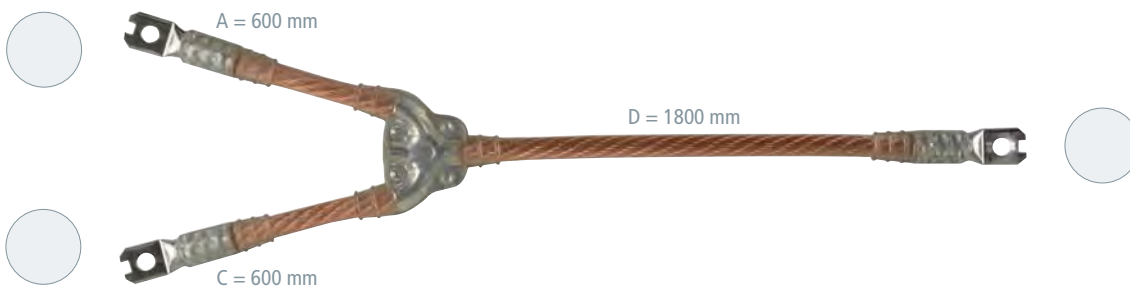

General Information:

Material	Cu
Crimped cable lug	PK1

Type	EKV2+0 16 G V7265NS	EKV2+0 25 G VZL6TGH	EKV2+0 35 G VPHPV2	EKV2+0 50 G VJ13VWW
Variant No.	V7265NS	VZL6TGH	VPHPV2	VJ13VWW
Cable cross-section	16 mm ²	25 mm ²	35 mm ²	50 mm ²
Max. short-circuit current I_k 0.5 s	4.5 kA	7.0 kA	10.0 kA	14.0 kA
Max. short-circuit current I_k 1 s	3.2 kA	4.9 kA	6.9 kA	9.9 kA

Type	EKV2+0 70 G VTJKEZU	EKV2+0 95 G VAM7M6H	EKV2+0 120 G V797FE6	EKV2+0 150 G VLL6JWS
Variant No.	VTJKEZU	VAM7M6H	V797FE6	VLL6JWS
Cable cross-section	70 mm ²	95 mm ²	120 mm ²	150 mm ²
Max. short-circuit current I_k 0.5 s	19.5 kA	26.5 kA	33.5 kA	42.0 kA
Max. short-circuit current I_k 1 s	13.8 kA	18.7 kA	23.7 kA	29.6 kA

Attention: Please state the relevant Variant No. when ordering.

4. Carry out Earthing and Short-Circuiting – EaS Devices

Three-pole Earthing and Short-Circuiting Cables, copper version, same cable cross-section

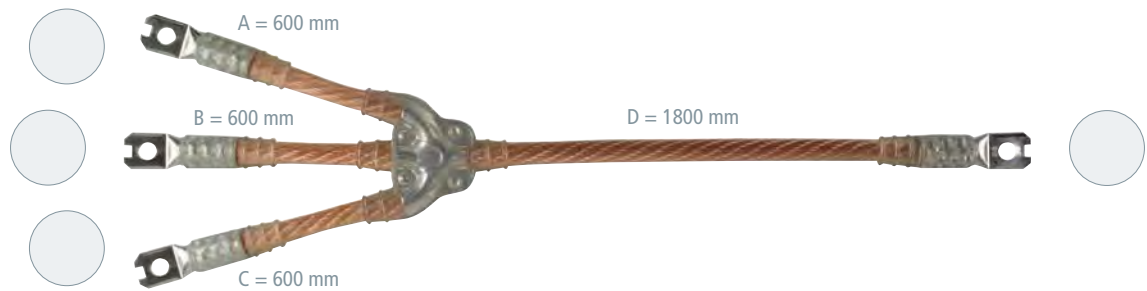

General Information:

Material	Cu
Crimped cable lug	PK1

Type	EKV3+0 16 G VE5MT89	EKV3+0 25 G VNC1S9W	EKV3+0 35 G V18JQHQ	EKV3+0 50 G VJ7VGZD
Variant No.	VE5MT89	VNC1S9W	V18JQHQ	VJ7VGZD
Cable cross-section	16 mm ²	25 mm ²	35 mm ²	50 mm ²
Max. short-circuit current I _k 0.5 s	4.5 kA	7.0 kA	10.0 kA	14.0 kA
Max. short-circuit current I _k 1 s	3.2 kA	4.9 kA	6.9 kA	9.9 kA

Type	EKV3+0 70 G VH95BZZ	EKV3+0 95 G VM2J7S3	EKV3+0 120 G V8D4AQ2	EKV3+0 150 G VG3V6T2
Variant No.	VH95BZZ	VM2J7S3	V8D4AQ2	VG3V6T2
Cable cross-section	70 mm ²	95 mm ²	120 mm ²	150 mm ²
Max. short-circuit current I _k 0.5 s	19.5 kA	26.5 kA	33.5 kA	42.0 kA
Max. short-circuit current I _k 1 s	13.8 kA	18.7 kA	23.7 kA	29.6 kA

Attention: Please state the relevant Variant No. when ordering.

Three-pole Earthing and Short-Circuiting Cables, copper version, reduced cable cross-section

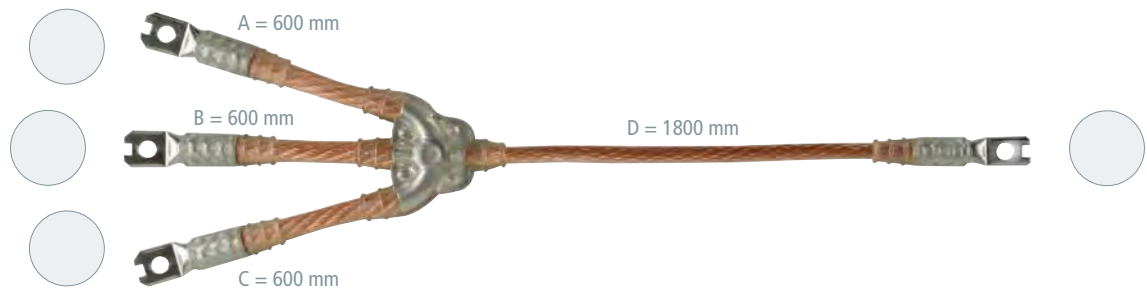

General Information:

Material	Cu
Crimped cable lug	PK1

Type	EKV3+0 50 R VN35H5D	EKV3+0 70 R VTCS2XV	EKV3+0 95 R VLB2F3G
Variant No.	VN35H5D	VTCS2XV	VLB2F3G
Cable cross-section	50/25 mm ²	70/35 mm ²	95/35 mm ²
Max. short-circuit current I _k 0.5 s	14.0 kA	19.5 kA	26.5 kA
Max. short-circuit current I _k 1 s	9.9 kA	13.8 kA	18.7 kA

Type	EKV3+0 120 R V8115WA	EKV3+0 150 R V11E77B
Variant No.	V8115WA	V11E77B
Cable cross-section	120/50 mm ²	150/50 mm ²
Max. short-circuit current I _k 0.5 s	33.5 kA	42.0 kA
Max. short-circuit current I _k 1 s	23.7 kA	29.6 kA

Attention: Please state the relevant Variant No. when ordering.

4. Carry out Earthing and Short-Circuiting – EaS Devices

Four-pole Earthing and Short-Circuiting Cables, copper version

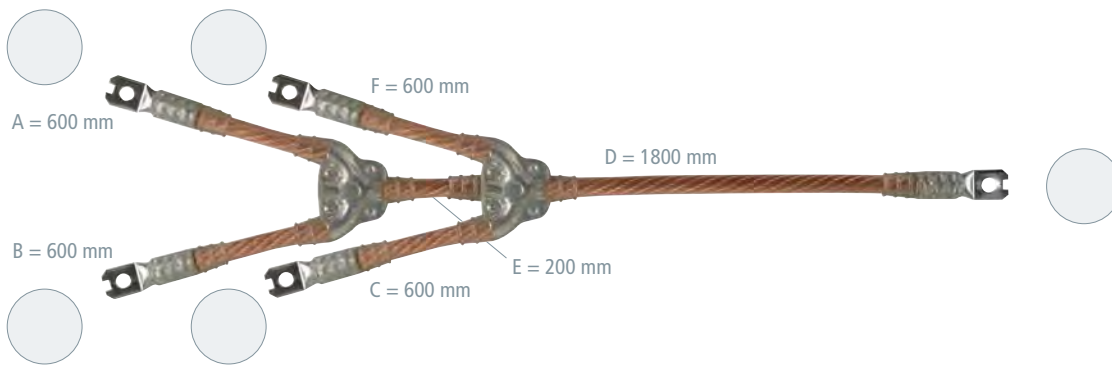

General Information:

Material	Cu
Crimped cable lug	PK1

Type	EKV4u0 16 G VGUVRRG	EKV4u0 25 G VGM214B	EKV4u0 35 G V93UVAP	EKV4u0 50 G V3NC SHX
Variant No.	VGUVRRG	VGM214B	V93UVAP	V3NC SHX
Cable cross-section	16 mm ²	25 mm ²	35 mm ²	50 mm ²
Max. short-circuit current I_k 0.5 s	4.5 kA	7.0 kA	10.0 kA	14.0 kA
Max. short-circuit current I_k 1 s	3.2 kA	4.9 kA	6.9 kA	9.9 kA

Type	EKV4u0 70 G V7GN8WU	EKV4u0 95 G VABRSSE	EKV4u0 120 G V27E2GP	EKV4u0 150 G V291ZZT
Variant No.	V7GN8WU	VABRSSE	V27E2GP	V291ZZT
Cable cross-section	70 mm ²	95 mm ²	120 mm ²	150 mm ²
Max. short-circuit current I_k 0.5 s	19.5 kA	26.5 kA	33.5 kA	42.0 kA
Max. short-circuit current I_k 1 s	13.8 kA	18.7 kA	23.7 kA	29.6 kA

Attention: Please state the relevant Variant No. when ordering.

Five-pole Earthing and Short-Circuiting Cables, copper version

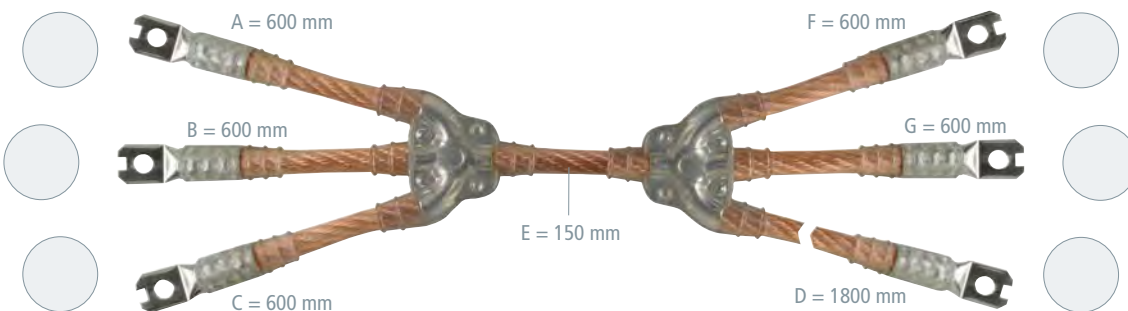

General Information:

Material	Cu
Crimped cable lug	PK1

Type	EKV5+0 16 G VQ7PF5A	EKV5+0 25 G VZKQZB5	EKV5+0 35 G V76D5TH	EKV5+0 50 G V6VE249
Variant No.	VQ7PF5A	VZKQZB5	V76D5TH	V6VE249
Cable cross-section	16 mm ²	25 mm ²	35 mm ²	50 mm ²
Max. short-circuit current I_k 0.5 s	4.5 kA	7.0 kA	10.0 kA	14.0 kA
Max. short-circuit current I_k 1 s	3.2 kA	4.9 kA	6.9 kA	9.9 kA

Type	EKV5+0 70 G VDXTBGF	EKV5+0 95 G VGCMAA5	EKV5+0 120 G VVL7AKP	EKV5+0 150 G VHV1NKR
Variant No.	VDXTBGF	VGCMAA5	VVL7AKP	VHV1NKR
Cable cross-section	70 mm ²	95 mm ²	120 mm ²	150 mm ²
Max. short-circuit current I_k 0.5 s	19.5 kA	26.5 kA	33.5 kA	42.0 kA
Max. short-circuit current I_k 1 s	13.8 kA	18.7 kA	23.7 kA	29.6 kA

Attention: Please state the relevant Variant No. when ordering.

Note:

If you have no Internet access, please fill in the template (DEHN form No. 2151) and send it to us!

4. Carry out Earthing and Short-Circuiting – EaS Devices

Earthing Cable Cu in accordance with IEC 61138

The cable is delivered without crimped cable lugs and can be ordered by the metre.

General Information:

Minimum order quantity ^{*)}	1 m
--------------------------------------	-----

Type	ES YM2 16	ES YM2 25	ES YM2 35	ES YM2 50
Part No.	716 001	725 001	735 001	750 001
Cable cross-section	16 mm ²	25 mm ²	35 mm ²	50 mm ²

Type	ES YM2 70	ES YM2 95	ES YM2 120	ES YM2 150
Part No.	770 001	795 001	712 001	715 001
Cable cross-section	70 mm ²	95 mm ²	120 mm ²	150 mm ²

^{*)} Length of earthing cable to be specified when ordering (in whole metres).

50 mm² Cu ES

4. Carry out Earthing and Short-Circuiting – EaS Devices

Phase Connecting Elements for Switchgear Installations

- To be fitted to the phase cable end of single-pole to five-pole earthing and short-circuiting devices
- Anti-rotation element PK1
- Other earthing and short-circuiting devices can be configured online via the earthing and short-circuiting configurator

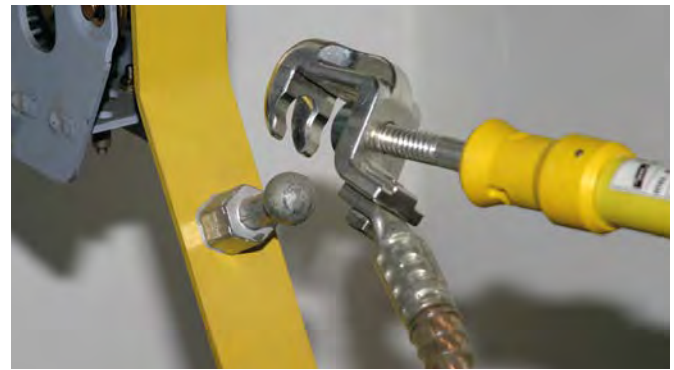

Connecting the phase cable end with universal clamp to a fixed ball point

General Information:

Standard	EN/IEC 61230 (DIN VDE 0683-100), threaded T pin shaft DIN 48087
Temperature range	-25 °C ... +55 °C
Material (clamp body)	Cu alloy/gal Sn
Material (terminal lug)	Cu alloy/gal Sn
Material (shaft)	Cu alloy/gal Sn
Material (pressure plate)	Cu alloy/gal Sn / St/Zn



SK: Hexagon shaft

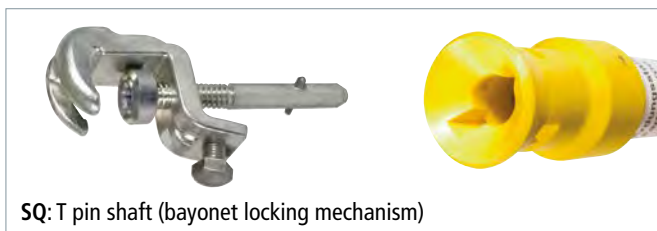

SQ: T pin shaft (bayonet locking mechanism)

Two types of ball head caps are available:

- Rigid ball head cap
- Adjustable ball head cap (4x 90°)

The adjustable ball head cap allows the user to connect the earthing and short-circuiting device to fixed ball points that are installed in unfavourable positions. Thus, in the vast majority of cases, angled fixed ball points no longer have to be used.



Rigid ball head cap



Adjustable ball head cap (4x 90°)



Rigid Ball Head Cap, Hexagon Shaft

Type	KKH 20 SK	KKH 25 SK
Part No.	772 310	772 320
For fixed ball point Ø	20 mm	25 mm
Anti-rotation element	PK1	PK1
For cable cross-section Cu	16 ... 120 mm ²	16 ... 150 mm ²
Max. short-circuit current I _k 0.5 s	33.5 kA	42.0 kA
Max. short-circuit current I _k 1 s	23.7 kA	29.6 kA



Rigid Ball Head Cap, T Pin Shaft

Type	KKH 20 SQ	KKH 25 SQ
Part No.	772 311	772 321
For fixed ball point Ø	20 mm	25 mm
Anti-rotation element	PK1	PK1
For cable cross-section Cu	16 ... 120 mm ²	16 ... 150 mm ²
Max. short-circuit current I _k 0.5 s	33.5 kA	42.0 kA
Max. short-circuit current I _k 1 s	23.7 kA	29.6 kA



4. Carry out Earthing and Short-Circuiting – EaS Devices

Adjustable Ball Head Cap (4x 90°), Hexagon Shaft



Type	KKH 20 D SK	KKH 25 D SK
Part No.	772 330	772 340
For fixed ball point Ø	20 mm	25 mm
Anti-rotation element	PK1	PK1
For cable cross-section Cu	16 ... 120 mm ²	16 ... 150 mm ²
Max. short-circuit current I _k 0.5 s	33.5 kA	42.0 kA
Max. short-circuit current I _k 1 s	23.7 kA	29.6 kA

Adjustable Ball Head Cap (4x 90°), T Pin Shaft



Type	KKH 20 D SQ	KKH 25 D SQ
Part No.	772 331	772 341
For fixed ball point Ø	20 mm	25 mm
Anti-rotation element	PK1	PK1
For cable cross-section Cu	16 ... 120 mm ²	16 ... 150 mm ²
Max. short-circuit current I _k 0.5 s	33.5 kA	42.0 kA
Max. short-circuit current I _k 1 s	23.7 kA	29.6 kA

Round Pin Clamp, T Pin Shaft

For round pins in switchgear installations.



Type	RBK 25 SQ SN7151	RBK 26 SQ SN7255	RBK 30 SQ SN7642	RBK 35 SQ
Part No.	715 314	715 315	715 313	715 312
For round pins Ø	25 mm	26 mm	30 mm	35 mm
Anti-rotation element	PK1	PK1	PK1	PK1
For cable cross-section Cu	16 ... 150 mm ²	16 ... 150 mm ²	16 ... 150 mm ²	16 ... 150 mm ²
Max. short-circuit current I _k 0.5 s	42.0 kA	42.0 kA	42.0 kA	42.0 kA
Max. short-circuit current I _k 1 s	29.6 kA	29.6 kA	29.6 kA	29.6 kA

Universal Clamp, Hexagon Shaft



Type	UK 25 SK	UK 30 SK
Part No.	773 034	773 130
For fixed ball point Ø	20 / 25 mm	25 / 30 mm
For T pins with a collar width of	15 mm	18 mm
Rd / Fl clamping range	20 mm	30 mm
Anti-rotation element	PK1	PK1
For cable cross-section Cu	16 ... 120 ^{*)} mm ²	16 ... 120 ^{*)} mm ²
Max. short-circuit current I _k 0.5 s	33.5 kA	33.5 kA
Max. short-circuit current I _k 1 s	23.7 kA	23.7 kA

^{*)} See table for "Clamping range and maximum cable cross-section of universal clamps used for"

Universal Clamp, T Pin Shaft



Type	UK 25 SQ	UK 30 SQ
Part No.	773 234	773 330
For fixed ball point Ø	20 / 25 mm	25 / 30 mm
For T pins with a collar width of	15 mm	18 mm
Rd / Fl clamping range	20 mm	30 mm
Anti-rotation element	PK1	PK1
For cable cross-section Cu	16 ... 120 ^{*)} mm ²	16 ... 120 ^{*)} mm ²
Max. short-circuit current I _k 0.5 s	33.5 kA	33.5 kA
Max. short-circuit current I _k 1 s	23.7 kA	23.7 kA

^{*)} See table for "Clamping range and maximum cable cross-section of universal clamps used for"

Phase Connecting Element, T Pin Shaft

With M16 threaded pin for installation in switchgear installations.



Type	PAS EK SQ 16
Part No.	771 316
Dimensions	M16
Anti-rotation element	PK1
For cable cross-section Cu	16 ... 150 mm ²
Max. short-circuit current I _k 0.5 s	42.0 kA
Max. short-circuit current I _k 1 s	29.6 kA

^{*)} Clamping range and maximum cable cross-section of universal clamps used for:

Fixed ball point Ø	T Pin Collar width	Rd / Fl Clamping range	Max. cable cross-section Cu
20 / 25 / 30 mm	15 / 18 mm	20 / 30 mm	16 mm ²
20 / 25 / 30 mm	15 / 18 mm	20 / 30 mm	25 mm ²
20 / 25 / 30 mm	15 / 18 mm	20 / 30 mm	35 mm ²
20 / 25 / 30 mm	15 / 18 mm	20 / 30 mm	50 mm ²
20 / 25 / 30 mm	15 / 18 mm	20 / 30 mm	70 mm ²
20 / 25 / 30 mm	15 / 18 mm	—	95 mm ²
— / 25 / 30 mm	—	—	120 mm ²
—	—	—	150 mm ²

The clamps must have the same maximum short-circuit current as the earthing and short-circuiting cables!

4. Carry out Earthing and Short-Circuiting – EaS Devices

Phase Connecting Elements for Overhead Lines

- For connecting the phase cables of single-pole and three-pole earthing and short-circuiting devices to overhead lines
- With coupling aid for safe attachment on conductor cables
- Easy coupling due to spring-loaded clamp
- Anti-rotation element PK1 or PK2 and long threaded T pin shaft
- Earthing and short-circuiting devices can be configured online via the earthing and short-circuiting configurator



Phase screw clamps used on an overhead line



General Information:	
Standard	EN/IEC 61230 (DIN VDE 0683-100), threaded T pin shaft DIN 48087
Temperature range	-25 °C ... +55 °C
Material (pressure plate)	Aluminium alloy
Material (clamp body)	Aluminium alloy
Material (shaft)	Copper alloy/gal Sn or StSt
Material (coupling aid)	St/gal Zn



Crimped cable lug, type PK1:
Standard anti-rotation cable lug with cut-out.



Crimped cable lug, type PK2:
Cable lugs without cut-out for connecting parts from other manufacturers are available on request.



Clamp with long shaft and earthing stick with aluminium cone coupling



Spring-loaded phase screw clamp

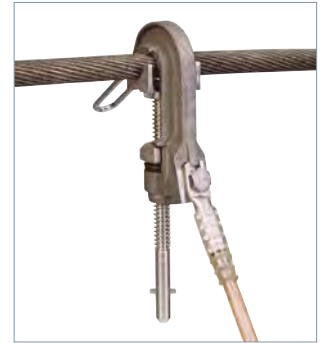

Phase screw clamp fitted with fixed coupling aid allows safe coupling

Standard Phase Screw Clamp

Short-circuit-proof, even if the conductor cables are corroded due to weathering.

Type	PSK 4 30 SQL	PSK 10 65 SQL
Part No.	784 201	784 301
Clamping range Ø	4 ... 30 mm	10 ... 65 mm
Anti-rotation element	PK1	PK1
For cable cross-section Cu	16 ... 70 mm ²	16 ... 120 mm ²
Max. short-circuit current I _k 0.5 s	19.5 kA	33.5 kA
Max. short-circuit current I _k 1 s	13.8 kA	23.7 kA



Phase Screw Clamp with Coupling Aid

Short-circuit-proof, even if the conductor cables are corroded due to weathering.

Type	PSK 4 30 SQL EH	PSK 10 65 SQL EH
Part No.	784 401	784 501
Clamping range Ø	4 ... 30 mm	10 ... 65 mm
Anti-rotation element	PK1	PK1
For cable cross-section Cu	16 ... 70 mm ²	16 ... 120 mm ²
Max. short-circuit current I _k 0.5 s	19.5 kA	33.5 kA
Max. short-circuit current I _k 1 s	13.8 kA	23.7 kA



4. Carry out Earthing and Short-Circuiting – EaS Devices

**Spring-loaded Phase Screw Clamp**

Easy coupling due to spring-loaded clamp.

Type	PSK FV 4 30 SQL
Part No.	784 480
Clamping range \varnothing	4 ... 30 mm
Anti-rotation element	PK1
For cable cross-section Cu	16 ... 70 mm ²
Max. short-circuit current I_k 0.5 s	19.5 kA
Max. short-circuit current I_k 1 s	13.8 kA

Spring-loaded Phase Screw Clamp, Earthing Stick and and EaS Cable

Easy coupling due to spring-loaded clamp.

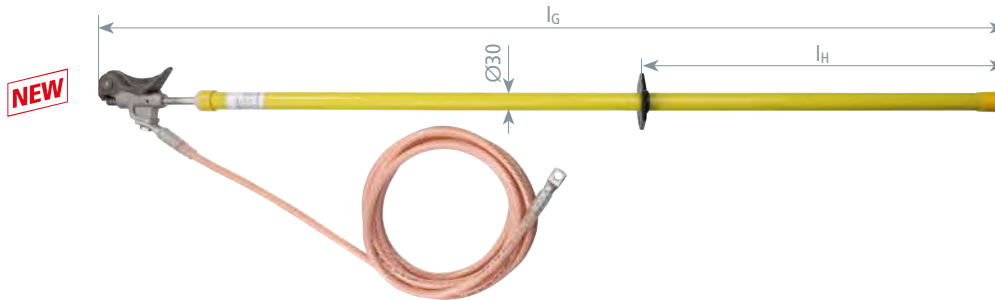

Type	PSK FV 4 30 SN7084
Part No.	768 029 ^{NEW}
Clamping range \varnothing	4 ... 30 mm
Cable cross-section	50 mm ²
Max. short-circuit current I_k 0.5 s	14.0 kA
Max. short-circuit current I_k 1 s	9.9 kA
Total length	1500 mm
Length (handle)	585 mm
Cable length	5500 mm
Type of crimped cable lug	PK2

**Phase Screw Clamp with Wide Clamping Range**

Ideally suited for use with Al and Al/St conductor cables, pipes and fixed phase points.

Type	PSK 10 85 SQL
Part No.	784 085
Clamping range \varnothing	10 ... 85 mm
Anti-rotation element	PK2
For cable cross-section Cu	16 ... 150 mm ²
Max. short-circuit current I_k 0.5 s	29.6 kA
Max. short-circuit current I_k 1 s	29.6 kA

Phase Screw Clamp with Wide Clamping Range and Telescopic Earthing Stick

Ideally suited for use with Al and Al/St conductor cables, pipes and fixed phase points.

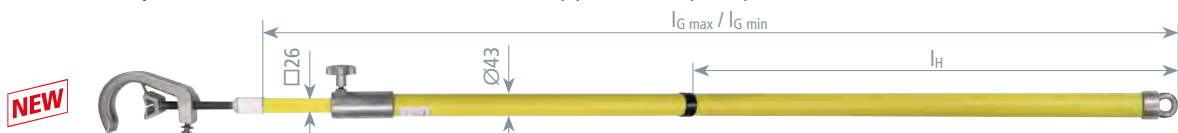

Type	ESTC PSK 5000 SN7249
Part No.	769 511
Clamping range \varnothing	10 ... 85 mm
Anti-rotation element	PK2
For cable cross-section Cu	16 ... 150 mm ²
Max. short-circuit current I_k 0.5 s	29.6 kA
Max. short-circuit current I_k 1 s	29.6 kA
Total length ($l_{G \max} / l_{G \min}$)	5190 / 2870 mm
Length (handle)	1900 mm

4. Carry out Earthing and Short-Circuiting – EaS Devices

Phase Screw Clamp

... with Safety Bow

Ideally suited for use in inclined positions.

Type	PSK 10 32 SQL SB	PSK 10 32 SQL
Part No.	784 038	784 032
Clamping range \emptyset	10 ... 32 mm	10 ... 32 mm
Anti-rotation element	PK2	PK2
For cable cross-section Cu	16 ... 95 mm ²	16 ... 95 mm ²
Max. short-circuit current I_k 0.5 s	18.7 kA	18.7 kA
Max. short-circuit current I_k 1 s	18.7 kA	18.7 kA



Rigid Ball Head Cap

Type	KKH 20 SQL	KKH 25 SQL
Part No.	772 314	772 324
For fixed ball point \emptyset	20 mm	25 mm
Anti-rotation element	PK1	PK1
For cable cross-section Cu	16 ... 120 mm ²	16 ... 150 mm ²
Max. short-circuit current I_k 0.5 s	33.5 kA	42.0 kA
Max. short-circuit current I_k 1 s	23.7 kA	29.6 kA



Universal Clamp

Type	UK 25 SQL	UK 30 SQL
Part No.	773 236	773 331
For fixed ball point \emptyset	20 / 25 mm	25 / 30 mm
For T pins with a collar width of	15 mm	18 mm
Rd / Fl clamping range	20 mm	30 mm
Anti-rotation element	PK1	PK1
For cable cross-section Cu	16 ... 120 ^{*)} mm ²	16 ... 120 ^{*)} mm ²
Max. short-circuit current I_k 0.5 s	33.5 kA	33.5 kA
Max. short-circuit current I_k 1 s	23.7 kA	23.7 kA



*) See table for "Clamping range and maximum cable cross-section of universal clamps used for"

The clamps must be designed for the same maximum short-circuit current as the earthing and short-circuiting cables!

*) Clamping range and maximum cable cross-section of universal clamps used for:

Fixed ball point \emptyset	T Pin Collar width	Rd / Fl Clamping range	Max. cable cross-section Cu
20 / 25 / 30 mm	15 / 18 mm	20 / 30 mm	16 mm ²
20 / 25 / 30 mm	15 / 18 mm	20 / 30 mm	25 mm ²
20 / 25 / 30 mm	15 / 18 mm	20 / 30 mm	35 mm ²
20 / 25 / 30 mm	15 / 18 mm	20 / 30 mm	50 mm ²
20 / 25 / 30 mm	15 / 18 mm	20 / 30 mm	70 mm ²
20 / 25 / 30 mm	15 / 18 mm	—	95 mm ²
— / 25 / 30 mm	—	—	120 mm ²
—	—	—	150 mm ²

Accessories for Phase Connecting Elements for Overhead Lines

Two-pole phase connecting plate

Allows to connect two phase screw clamps with PK1 anti-rotation element.

Type	PAP 2 M12 SSM B13
Part No.	728 312
Anti-rotation cable lug	PK1
Borehole	\emptyset 12.5 mm
Max. short-circuit current I_k 0.5 s	33.5 kA
Max. short-circuit current I_k 1 s	23.7 kA



Three-pole phase connecting plate with round pin

Phase connecting plate for phase clamps.

Type	PAP 3 M12 SSM B13 RB
Part No.	728 313
Anti-rotation cable lug	PK1
Borehole	\emptyset 12.5 mm
Max. short-circuit current I_k 0.5 s	33.5 kA
Max. short-circuit current I_k 1 s	23.7 kA



4. Carry out Earthing and Short-Circuiting – EaS Devices

Phase Connecting Elements for Railway Applications



- Safe positive-locking earth clamps for railway applications



Coupling the earth clamp to the overhead contact line.



Earth Clamp for Overhead Contact Lines

With contact electrode and flexible threaded T pin shaft according to DIN 48087.
For AC-80 to AC-120 overhead contact lines.

Type	FEK 4 15 TS FSQL	FEK4 15 TS FSQL AB29
Part No.	784 755	784 756
Clamping range Ø	4 ... 15 mm	4 ... 15 mm
Anti-rotation cable lug	PK2 (Ø10.5 mm)	PK2 (Ø10.5 mm)
For cable material	Cu	Al
For cable cross-section	50 mm ²	70 mm ²
Max. short-circuit current I _k 0.06 s	34.0 kA	32.0 kA
DB drawing No.	3 Ebgw 01.54	Ebgw 01.85
DB material No.	157 536	—



Line Clamp

With contact electrode and threaded T pin shaft according to DIN 48087.
For supply and traction power lines.

Type	LK 4 40 TS SQL
Part No.	784 352
Clamping range Ø	4 ... 40 mm
Anti-rotation cable lug	PK2 (Ø10.5 mm)
DB drawing No.	3 Ebgw 01.65
DB material No.	157 539

4. Carry out Earthing and Short-Circuiting – EaS Devices

Earthing Kit

- For overhead line systems
- For driving the tubular earth electrode into the ground
- Kit consists of a tubular earth electrode with drill, 3-pole earthing busbar and transport bag

General Information:

Material (tubular earth electrode)	St/tZn
Material (bolt)	StSt (V2A)
Material (handle)	Wood
Material (earthing busbar)	St/tZn



Earthing busbar and earthing cables mounted on a tubular earth electrode

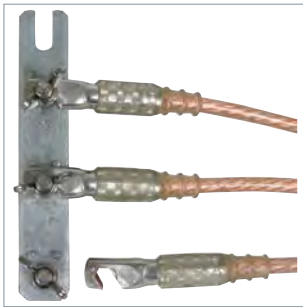

Crimped cable lugs, type PK3:
Anti-rotation hook-type cable lug mounted on a three-pole earthing busbar.

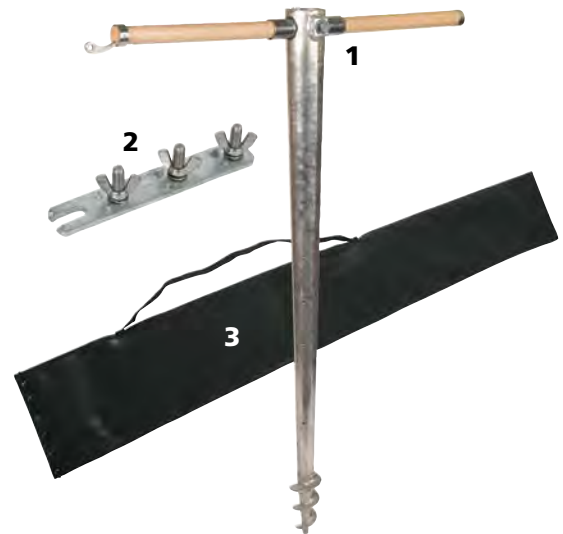

Earthing Kit

For three-pole earthing devices.

Type	ES 3P FL ER
Part No.	799 009
Total length (l _G)	1000 mm
Bolt	M10 x 35 mm

Kit includes:

Pos.	Part No.	Pos.	Part No.
1	644 000	3	766 601
2	799 019		

More details on the bag, see chapter Storage Bags and Transport Cases.

Accessories for Earthing Kit

Tubular earth electrode with drill

Type	ERO BSP ASSM10 1000 STTZN
Part No.	644 000
Length (drill)	1000 mm
Stock No.	5975-12-120-0006

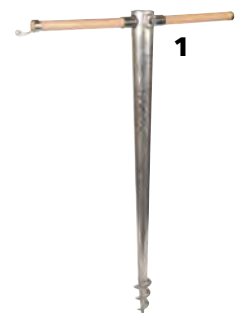

Three-pole earthing busbar

With slot for mounting the earthing busbar on the tubular earth electrode, for hook-type cable lugs of type PK3.

Type	ESS 3P M10 FM
Part No.	799 019
Dimensions	180 x 30 x 5 mm
Bolt	3x M10 x 35 mm



4. Carry out Earthing and Short-Circuiting – EaS Devices

Earthing Spike



Earthing spike with coiled earthing cable.

- To be driven into the soil
- Two half-shells for earthing or extension cables
- Hot-dip galvanised version

General Information:

Material	St/tZn
Material (bolt)	St/St



Type	ESP HVS 1500
Part No.	799 006
Total length (l _G)	1500 mm
Bolt	M12 x 25 mm

*) Clamping range and cable cross-section for universal clamps on:

Fixed ball point Ø	T Pin Collar width	Rd / Fl Clamping range	Max. cable cross-section Cu
20 / 25 / 30 mm	15 / 18 mm	20 / 30 mm	16 mm ²
20 / 25 / 30 mm	15 / 18 mm	20 / 30 mm	25 mm ²
20 / 25 / 30 mm	15 / 18 mm	20 / 30 mm	35 mm ²
20 / 25 / 30 mm	15 / 18 mm	20 / 30 mm	50 mm ²
20 / 25 / 30 mm	15 / 18 mm	20 / 30 mm	70 mm ²
20 / 25 / 30 mm	15 / 18 mm	—	95 mm ²
— / 25 / 30 mm	—	—	120 mm ²
—	—	—	150 mm ²

Earth Connecting Elements for Switchgear Installations and Overhead Lines



Universal earth clamp with handle connected to a fixed ball point

Clamping range up to 40 mm

- For connecting the earth cable end to fixed ball points, T pins, round and flat conductors, connecting elements and flat profiles
- For wide clamping ranges up to 40 mm
- Anti-rotation element of type PK1 or PK2
- Earthing and short-circuiting devices can be configured online by means of the earthing and short-circuiting configurator

General Information:

Standard	EN/IEC 61230 (DIN VDE 0683-100)
Temperature range	-25 °C ... +55 °C
Material (clamp body)	Cu alloy/gal Sn / MCl/gal Zn
Material (shaft)	Cu alloy/gal Sn / brass/gal Zn
Material (pressure plate)	Cu alloy/gal Sn / St/gal Zn
Material (terminal lug)	E-Cu/gal Sn
Material (wing nut)	Cu alloy/gal Sn
Material (milling plate)	St, hardened / chromed
Material (spring)	Spring steel



4. Carry out Earthing and Short-Circuiting – EaS Devices

Universal Clamp with Wing Bolt

Type	UEK 25 FS	UEK 30 FS
Part No.	774 034	774 130
For fixed ball point Ø	20 / 25 mm	25 / 30 mm
For T pins with a collar width of	15 mm	18 mm
Rd / Fl clamping range	20 mm	30 mm
Anti-rotation cable lug	PK1	PK1
For cable cross-section Cu	16 ... 120 ^{*)} mm ²	16 ... 120 ^{*)} mm ²
Max. short-circuit current I _k 0.5 s	33.5 kA	33.5 kA
Max. short-circuit current I _k 1 s	23.7 kA	23.7 kA

*) See table 'Clamping range and cable cross-section for universal clamps on:'



Universal Clamp with Handle

Type	UEK 25 HG	UEK 30 HG
Part No.	774 234	774 330
For fixed ball point Ø	20 / 25 mm	25 / 30 mm
For T pins with a collar width of	15 mm	18 mm
Rd / Fl clamping range	20 mm	30 mm
Anti-rotation cable lug	PK1	PK1
For cable cross-section Cu	16 ... 120 ^{*)} mm ²	16 ... 120 ^{*)} mm ²
Max. short-circuit current I _k 0.5 s	33.5 kA	33.5 kA
Max. short-circuit current I _k 1 s	23.7 kA	23.7 kA

*) See table 'Clamping range and cable cross-section for universal clamps on:'



Universal Clamp with Tommy Bar

Type	UEK 25 SKN	UEK 30 SKN
Part No.	774 434	774 530
For fixed ball point Ø	20 / 25 mm	30 mm
For T pins with a collar width of	15 mm	18 mm
Rd / Fl clamping range	20 mm	30 mm
Anti-rotation cable lug	PK1	PK1
For cable cross-section Cu	16 ... 120 ^{*)} mm ²	16 ... 120 ^{*)} mm ²
Max. short-circuit current I _k 0.5 s	33.5 kA	33.5 kA
Max. short-circuit current I _k 1 s	23.7 kA	23.7 kA

*) See table 'Clamping range and cable cross-section for universal clamps on:'



Rigid Ball Head Cap with Wing Bolt

Type	KKH 20 FS	KKH 25 FS
Part No.	772 312	772 322
For fixed ball point Ø	20 mm	25 mm
Anti-rotation cable lug	PK1	PK1
For cable cross-section Cu	16 ... 120 mm ²	16 ... 150 mm ²
Max. short-circuit current I _k 0.5 s	33.5 kA	42.0 kA
Max. short-circuit current I _k 1 s	23.7 kA	29.6 kA



Rigid Ball Head Cap with Handle

Type	KKH 20 HG	KKH 25 HG
Part No.	772 313	772 323
For fixed ball point Ø	20 mm	25 mm
Anti-rotation cable lug	PK1	PK1
For cable cross-section Cu	16 ... 120 mm ²	16 ... 150 mm ²
Max. short-circuit current I _k 0.5 s	33.5 kA	42.0 kA
Max. short-circuit current I _k 1 s	23.7 kA	29.6 kA



4. Carry out Earthing and Short-Circuiting – EaS Devices

Earth Connecting Element with Wing Nut



Type	EAS EK FM 12	EAS EK FM 16
Part No.	775 621	775 631
Dimensions	M12	M16
Anti-rotation cable lug	PK1	PK1
For cable cross-section Cu	16 ... 150 mm ²	16 ... 150 mm ²
Max. short-circuit current I _k 0.5 s	42.0 kA	42.0 kA
Max. short-circuit current I _k 1 s	29.6 kA	29.6 kA

Earth Connecting Element with Wing Bolt



Type	EAS EK FS 12	EAS EK FS 16
Part No.	775 626	775 636
Dimensions	M12 x 15 mm	M16 x 15 mm
Anti-rotation cable lug	PK1	PK1
For cable cross-section Cu	16 ... 150 mm ²	16 ... 150 mm ²
Max. short-circuit current I _k 0.5 s	42.0 kA	42.0 kA
Max. short-circuit current I _k 1 s	29.6 kA	29.6 kA

Earth Bushing with Wing Bolt

For fixed earthing points with ring groove



Type	EAB RN 16 FS
Part No.	790 150
Dimensions	Ø16 mm
Anti-rotation cable lug	PK1
For cable cross-section Cu	16 ... 150 ^{*)} mm ²
Max. short-circuit current I _k 0.5 s	42.0 kA
Max. short-circuit current I _k 1 s	29.6 kA

^{*)} For cable lengths > 4000 mm: max. up to 95 mm² (26.5 kA / 0.5 s).

Earth Bushing with Tommy Bar

For fixed earthing points with ring groove



Type	EAB RN 16 SKN
Part No.	790 160
Dimensions	Ø16 mm
Anti-rotation cable lug	PK2
For cable cross-section Cu	16 ... 150 ^{**)} mm ²
Max. short-circuit current I _k 0.5 s	29.6 kA
Max. short-circuit current I _k 1 s	29.6 kA

^{**)} Max. short-circuit current of 29.6 kA even in case of a disconnection time I_k of 1 s.

Earth Milling Clamp with Tommy Bar and Disc Springs

Milling plate, disc springs and long tommy bar for reliable contact



Type	EFK FL40 SKN
Part No.	792 190
Clamping range	up to 40 mm
Anti-rotation cable lug	PK1
For cable cross-section Cu	16 ... 95 mm ²
Max. short-circuit current I _k 0.5 s	26.5 kA
Max. short-circuit current I _k 1 s	18.7 kA

Earth Milling Clamp with Tommy Bar

Milling plate and long tommy bar for reliable contact



Type	EFK FL30 SKN
Part No.	792 030
Clamping range	Up to 30 mm
Anti-rotation cable lug	PK1
For cable cross-section Cu	16 ... 50 mm ²
Max. short-circuit current I _k 0.5 s	14.0 kA
Max. short-circuit current I _k 1 s	9.9 kA

The clamps must have the same maximum short-circuit current as the earthing and short-circuiting cables!

4. Carry out Earthing and Short-Circuiting – EaS Devices

Earth Connecting Elements for Railway Applications

- Safe earth connection elements for railway applications



Clamp for railway tracks mounted on the track profile.

Clamp for Railway Tracks with Tommy Bar

With detachable tommy bar (locking spring).

For profile-free earthing of track profiles S49, S54, S64 and UIC60.

Type	SAK PFE KN	SAK PFE KN AB29
Part No.	792 450	792 451
Anti-rotation cable lug	PK2 (Ø10.5 mm)	PK2 (Ø10.5 mm)
Cable material	Cu	Al
For cable cross-section	50 mm ²	70 mm ²
Max. short-circuit current I_k 0.06 s	34.0 kA	32.0 kA
DB drawing No.	3 Ebgw 01.53	Ebgw 01.82
DB material No.	157 535	—



Clamp for Railway Tracks with Ratchet

With detachable ratchet.

For profile-free earthing of track profiles S49, S54, S64 and UIC60.

Type	SAK PFE RA	SAK PFE RA AB29
Part No.	792 453	792 454
Anti-rotation cable lug	PK2 (Ø10.5 mm)	PK2 (Ø10.5 mm)
Cable material	Cu	Al
For cable cross-section	50 mm ²	70 mm ²
Max. short-circuit current I_k 0.06 s	34.0 kA	32.0 kA
DB drawing No.	3 Ebgw 01.53	Ebgw 01.83
DB material No.	157 549	—



Universal Clamp, T Pin Shaft

T pin according to DIN 48087.

Type	UK K25 FL30 SQL
Part No.	773 251
For fixed ball point Ø	25 / 30 mm
Anti-rotation cable lug	PK2 (Ø10.5 mm)
For cable cross section Cu	50 mm ²
Max. short-circuit current I_k 0.06 s	34.0 kA
DB drawing No.	4 Ebgw 01.59
DB material No.	157 538



Universal Clamp with Handle

Type	UK K25 FL30 HG
Part No.	774 251
For fixed ball point Ø	25 / 30 mm
Anti-rotation cable lug	PK2 (Ø10.5 mm)
For cable cross section Cu	50 mm ²
Max. short-circuit current I_k 0.06 s	34.0 kA
DB drawing No.	4 Ebgw 01.64
DB material No.	157 537



4. Carry out Earthing and Short-Circuiting – EaS Devices

Earthing Sticks for Switchgear Installations

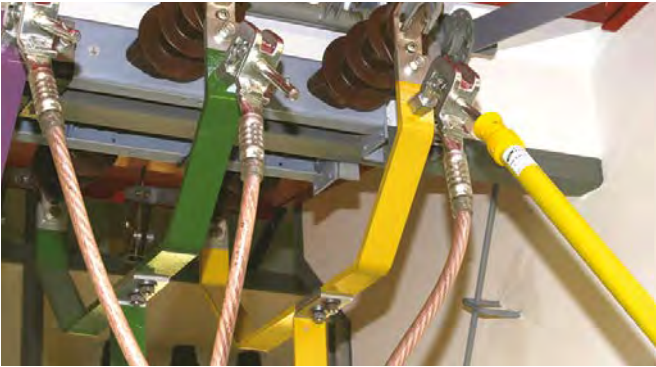

Earthing stick used for attaching an earthing and short-circuiting device to an installation.

- For attaching earthing and short-circuiting devices
- Available in different lengths
- Modular for easy transport
- Light-weight construction
- Hexagon shaft (WS 19 mm) or T pin shaft

General Information:

Standard	T pin shaft DIN 48087
Temperature range	-25 °C ... +55 °C
Material (insulating tube)	Glass-fibre reinforced polyester tube
End fitting	Non-slip plastic cap or plug-in coupling for extending the handle



Earthing sticks with bayonet locking mechanism (T pin shaft) can also be used for clamps with hexagon shaft by attaching an AES SQ SK adapter.



The plug-in coupling allows for easy handle extension of ES STK earthing sticks.

Earthing sticks are hand-held insulating sticks for approaching clamps of earthing and short-circuiting devices to parts of electrical installations for earthing and short-circuiting purposes.

They consist of an insulating element, black ring, handle and coupling for attaching clamps. Earthing sticks have to be selected according to the **weight** of the earthing and short-circuiting device (see also "max. load on the operating head in kg").

The **insulating element** is the part of the earthing stick between the black ring and the end of the earthing stick in the direction of the clamp. It ensures that the user maintains the required safety distance and provides sufficient insulation. In installations exceeding 1 kV, the insulating element must have a minimum length of 500 mm.

With hexagon shaft

Handle termination with end cap (spring locking mechanism)

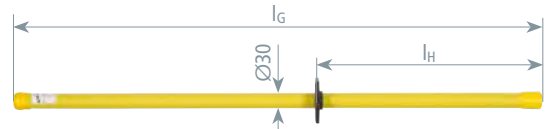

Type	ES SK 1000	ES SK 1500
Part No.	761 010	761 015
Total length (l_G)	1000 mm	1500 mm
Length (handle) (l_H)	430 mm	930 mm
Max. load on the operating head	35 kg	35 kg

With T pin shaft

Handle termination with end cap (bayonet locking mechanism)

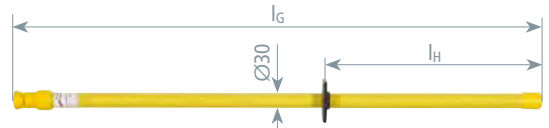

Type	ES SQ 1000	ES SQ 1500
Part No.	761 011	761 016
Total length (l_G)	1000 mm	1500 mm
Length (handle) (l_H)	430 mm	930 mm
Max. load on the operating head	35 kg	35 kg

4. Carry out Earthing and Short-Circuiting – EaS Devices

With hexagon shaft, plug-in coupling

Handle termination with plastic plug-in coupling for extending the handle (spring locking mechanism)

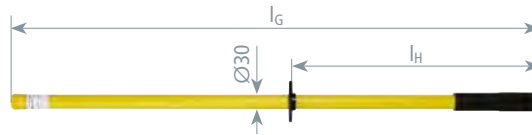

Type	ES SK STK 1000	ES SK STK 2000
Part No.	761 001	761 003
Total length (l_G)	1000 mm	2000 mm
Length (handle) (l_H)	430 mm	1430 mm
Max. load on the operating head	35 kg	14 kg



With T pin shaft, plug-in coupling

Handle termination with plastic plug-in coupling for extending the handle (bayonet locking mechanism)

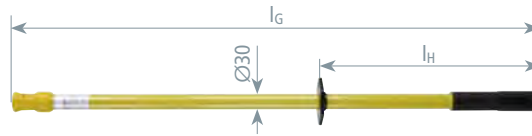

Type	ES SQ STK 1000	ES SQ STK 2000
Part No.	761 002	761 004
Total length (l_G)	1000 mm	2000 mm
Length (handle) (l_H)	430 mm	1430 mm
Max. load on the operating head	35 kg	14 kg



Telescopic with T pin shaft and plug-in coupling

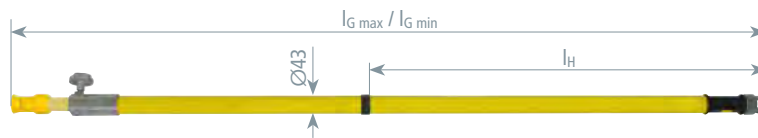

NEW

Type	ESTC SQ STK SN7562
Part No.	769 304
Total length ($l_G \text{ max} / l_G \text{ min}$)	2965 / 1715 mm
Length (handle) (l_H)	900 mm
Max. load on the operating head ($l_G \text{ max} / l_G \text{ min}$)	18 / 35 kg



Two-part, with hexagon shaft

Handle termination with plastic plug-in coupling for extending the handle (spring locking mechanism)

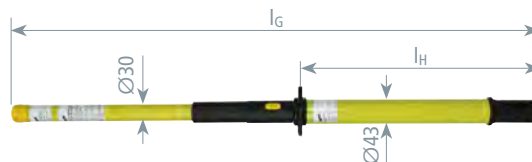

Type	EST SK STK 920
Part No.	761 070
Total length (l_G)	920 mm
Length (handle) (l_H)	415 mm
Max. load on the operating head	35 kg



Two-part, with T pin shaft

Handle termination with plastic plug-in coupling for extending the handle (bayonet locking mechanism)

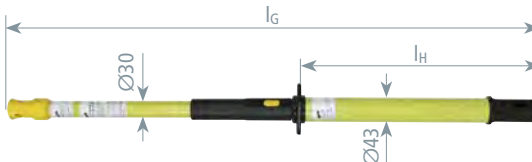

Type	EST SQ STK 920
Part No.	761 075
Total length (l_G)	920 mm
Length (handle) (l_H)	415 mm
Max. load on the operating head	35 kg



Accessories for Earthing Sticks for Switchgear Installations

Adapter (T pin shaft / hexagon shaft)

Suitable for insertion into earthing sticks with coupling for T pin shafts (bayonet locking mechanism) to accept clamps with hexagon shaft. The lock nut allows to fix the adapter on the earthing stick.

Type	AD ES SQ SK
Part No.	765 001
Length	130 mm



4. Carry out Earthing and Short-Circuiting – EaS Devices

Earthing Sticks for Overhead Lines



Telescopic earthing stick with aluminium cone coupling and phase screw clamp.

- For outdoor use
- Robust aluminium cone coupling
- Total lengths up to 6000 mm
- Length of telescopic stick continuously adjustable via star knob
- For phase screw clamps and clamps with long T pin shaft

General Information:

Temperature range	-25 °C ... +55 °C
Material (insulating tube)	Glass-fibre reinforced polyester tube
Material (threaded coupling, star knob)	Aluminium alloy
End fitting	Aluminium/rubber eye / Plug-in coupling for extending the handle



A square tube (26 mm) can be pulled out of the round insulating tube and can be fixed in any position between l_{min} and l_{max} using the star knob.

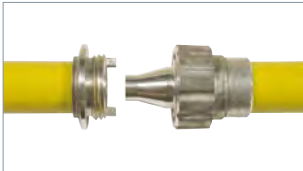

Robust aluminium threaded coupling allows positive and non-positive connection due to the screw connection and gearing.



End fitting with eye (Al/rubber) or plug-in coupling with eye (Al/rubber) for extending the handle.



Lockable adjusting ring

The adjusting ring on the cone has the following functions:

- Position "AUF" (= OPEN): Stick can be removed after the clamp has been attached
- Position "ZU" (= CLOSED): Stick and clamp remain coupled even after the earthing and short-circuiting device has been attached

Telescopic, with T pin shaft



Type	ESTC SQL 4000	ESTC SQL 5000
Part No.	769 400	769 500
Total length ($l_{G max}$ / $l_{G min}$)	4015 / 2180 mm	5015 / 2680 mm
Length (handle) (l_H)	1400 mm	1900 mm
Max. load on the operating head ($l_{G max}$ / $l_{G min}$)	12 / 35 kg	10 / 35 kg
Diameter	43 mm	43 mm

Telescopic, with T pin shaft, plug-in coupling

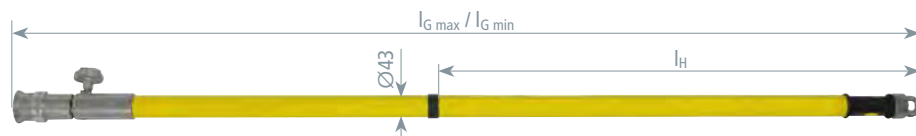

Type	ESTC SQL STK 3000
Part No.	769 300
Total length ($l_{G max}$ / $l_{G min}$)	2945 / 1615 mm
Length (handle) (l_H)	900 mm
Max. load on the operating head ($l_{G max}$ / $l_{G min}$)	18 / 35 kg
Diameter	43 mm

4. Carry out Earthing and Short-Circuiting – EaS Devices

Multi-part, top section

With aluminium bayonet coupling and aluminium threaded coupling as end fitting.



Type	EST KS SQL 1500
Part No.	769 503
Total length (l_G)	1600 mm
Diameter	43 mm

Permissible loads for the earthing sticks:		
Length l_G	Pos. No.	Max. load on the operating head
6000 mm	1+2+2+3	8 kg
4500 mm	1+2+3	15 kg
3000 mm	1+3	30 kg
1500 mm	1	35 kg

Multi-part, intermediate section

With aluminium threaded coupling, connector with nut and bushing.



Type	EST ZS 1500
Part No.	769 504
Total length (l_G)	1580 mm
Diameter	43 mm

Multi-part, end section

With connector and nut of the aluminium threaded coupling and end fitting with ring eye.



Type	EST ES 1500
Part No.	769 505
Total length (l_G)	1590 mm
Diameter	43 mm

Accessories for Earthing Sticks for Overhead Lines

Adapter (T pin shaft / long T pin shaft)

Suitable for insertion into earthing sticks with aluminium cone coupling for T pin shafts (bayonet locking mechanism) to accept clamps with T pin shaft.

The lock nut allows to fix the adapter on the earthing stick.

Type	AD ES SQ SQL
Part No.	765 006
Length	185 mm



4. Carry out Earthing and Short-Circuiting – EaS Devices

Earthing Sticks for Railway Applications



Attaching a railway earthing device.

For threaded T pin shafts (bayonet locking mechanism)

- For outdoor use
- Robust aluminium cone coupling
- Length of telescopic stick continuously adjustable via star knob
- Only suitable for phase screw clamps and clamps with long T pin shaft



General Information:

Standard	EN/IEC 61230 (DIN VDE 0683-100)
Temperature range	-25 °C ... +55 °C



Lockable adjusting ring

The adjusting ring on the cone has the following functions:

- Position "AUF" (= OPEN): Stick can be removed after the clamp has been attached
- Position "ZU" (= CLOSED): Stick and clamp remain coupled even after the earthing and short-circuiting device has been attached

Telescopic, with T pin shaft

For threaded T pin shafts (bayonet locking mechanism).

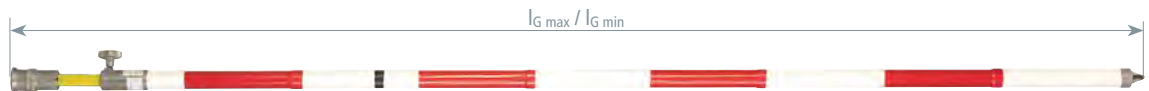

Type	ESTC SQL RW 3500	ESTC SQL RW 5000
Part No.	769 352	769 502
Total length ($l_{G \max} / l_{G \min}$)	3515 / 1935 mm	5015 / 2685 mm
Max. load on the operating head ($l_{G \max} / l_{G \min}$)	12 / 35 kg	10 / 35 kg
DB drawing No.	3 Ebgw 01.58	3 Ebgw 01.52
DB material No.	157 534	157 533

Telescopic, with T pin shaft and cable entry

For threaded T pin shaft (bayonet locking mechanism)

The coupling is additionally fitted with a cable entry and a hook for securing the earthing cable and earthing stick at the tower (without adjusting ring).

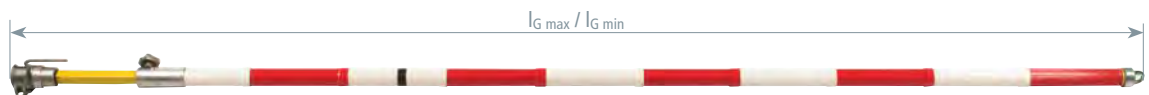

Type	ESTC SQL H RW 5000
Part No.	769 508
Total length ($l_{G \max} / l_{G \min}$)	5015 / 2685 mm
Max. load on the operating head ($l_{G \max} / l_{G \min}$)	10 / 35 kg
DB drawing No.	3 Ebgw 01.55
DB material No.	612 142

4. Carry out Earthing and Short-Circuiting – EaS Devices

Six-part, with T pin shaft and plastic coupling

For threaded T pin shafts (bayonet locking mechanism).



Type	EST SQL RW 4915 TA
Part No.	769 506
Total length ($l_{G \max}$ / $l_{G \min}$)	4915 / 1055 mm
Max. load on the operating head ($l_{G \max}$ / $l_{G \min}$)	10 / 35 kg
DB drawing No.	2 Ebgw 01.68
DB material No.	157 489

Kit includes:

Pos.	Part No.	Pos.	Part No.
1	1x 766 074	4	1x 766 079
2	2x 766 076	5	1x 766 889
3	1x 766 078	6	1x 769 509

For more detailed information on these products, see Accessories chapter.

Six-part, with T pin shaft and aluminium coupling

For threaded T pin shafts (bayonet locking mechanism).



Type	EST SQL RW 4855 TA
Part No.	769 515
Total length ($l_{G \max}$ / $l_{G \min}$)	4855 / 1035 mm
Max. load on the operating head ($l_{G \max}$ / $l_{G \min}$)	10 / 35 kg

Kit includes:

Pos.	Part No.	Pos.	Part No.
1	1x 769 516	4	1x 769 519
2	2x 769 517	5	1x 769 509
3	1x 769 518		

For more detailed information on these products, see Accessories chapter.

4. Carry out Earthing and Short-Circuiting – EaS Devices

EaS Configurator: Easy online configuration



- Easy online selection of the suitable EaS device
- Unique laser marking of the EaS device
- Individual configuration
- Permanent plausibility check in the background
- User-friendly interface
- To start the configuration, simply enter the Variant No., Part No. or Product configuration

General Information:	
Standard	EN/IEC 61138 (DIN VDE 0283-3) and EN/IEC 61230 (DIN VDE 0683-100)
Temperature range	-25 °C ... +55 °C
Material (cable)	Al, flexible; E-Cu, extra finely stranded and highly flexible
Material (sheath)	Thermoplastic (soft PVC compound YM2)
Hole (terminal lug)	Ø12.5 mm

With the help of the earthing and short-circuiting configurator customised earthing and short-circuiting devices (EaS) for switchgear installations and overhead lines can be configured online at www.dehn.de/de/euk. The configurator provides you with two options to start the configuration (product or system view).

The product view is ideally suited for users who know exactly what they need and already have a concrete idea of, for example, the cable cross-section and clamps to be used.

As an alternative, the system view can be selected. For this extended version of the product view, information on the installation must be provided.

The place of use (switchgear installation or overhead line) of the EaS device is decisive for the selection of the clamps.

A permanent plausibility check ensures reliable selection of the right device. Further accessories such as earthing sticks are optionally displayed for the configured EaS devices.

At the end of the configuration the result is graphically shown and a detailed description of the earthing and short-circuiting device is provided. Moreover a unique Variant No. is assigned to the application-specific earthing and short-circuiting device, which will be lasered on the device later.



You will find the EaS configurator and a demo version at

www.dehn.de/en/euk

The EaS configurator is graphically divided into three parts:

- On the left side, a tree structure of the given information is displayed. You can return to the history and change already selected information at any time. The tree structure allows a clearly structured configuration.
- In the centre you can select or change the required information via the keyboard or the mouse. This is done step by step meaning that a detail must be provided before the next detail is visible and selectable.
- On the right side, the current state is graphically displayed to ensure and facilitate optimal selection. Moreover, data may be entered in the relevant field.

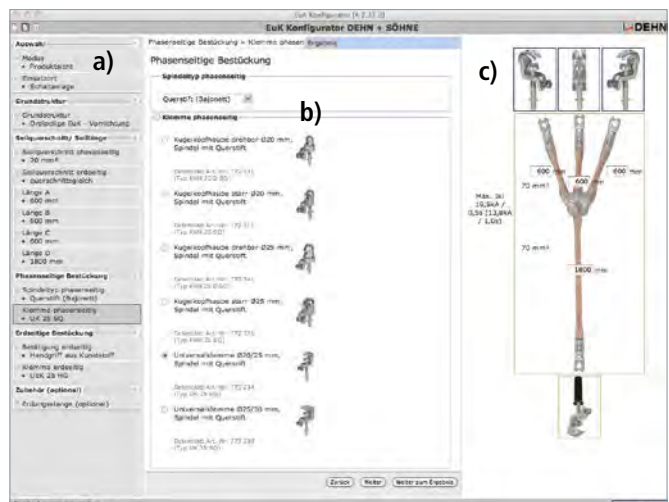

4. Carry out Earthing and Short-Circuiting – EaS Devices

Three-pole, same Cable Cross-Section with Ball Head Caps

... easy configuration ...



General Information:				
Earth cable end	EAS EK FM 12			
Type	EKV3+1 16 G VGJD2QX	EKV3+1 25 G VRDSN66	EKV3+1 35 G V3WJMY	EKV3+1 50 G VU8P6LE
Variant No.	VGJD2QX	VRDSN66	V3WJMY	VU8P6LE
Phase cable end	KKH 20 SK	KKH 20 SK	KKH 20 SK	KKH 20 SK
For fixed ball point Ø	20 mm	20 mm	20 mm	20 mm
Cable cross-section Cu	16 mm ²	25 mm ²	35 mm ²	50 mm ²
Max. short-circuit current I _k 0.5 s	4.5 kA	7.0 kA	10.0 kA	14.0 kA
Max. short-circuit current I _k 1 s	3.2 kA	4.9 kA	6.9 kA	9.9 kA
Type	EKV3+1 70 G VCEY1U6	EKV3+1 95 G VA3926U	EKV3+1 120 G VAB3PJV	EKV3+1 150 G V1KPXFR
Variant No.	VCEY1U6	VA3926U	VAB3PJV	V1KPXFR
Phase cable end	KKH 20 SK	KKH 20 SK	KKH 20 SK	KKH 25 SK
For fixed ball point Ø	20 mm	20 mm	20 mm	25 mm
Cable cross-section Cu	70 mm ²	95 mm ²	120 mm ²	150 mm ²
Max. short-circuit current I _k 0.5 s	19.5 kA	26.5 kA	33.5 kA	42.0 kA
Max. short-circuit current I _k 1 s	13.8 kA	18.7 kA	23.7 kA	29.6 kA

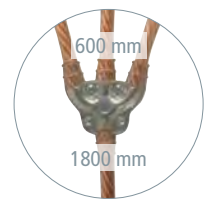
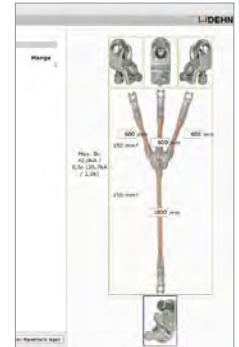

Three-pole, reduced Cable Cross-Section with Ball Head Caps

... easy configuration ...



General Information:			
Earth cable end	EAS EK FM 12		
Type	EKV3+1 50 R VD28FAD	EKV3+1 70 R VQYP8B2	EKV3+1 95 R V5SVXPH
Variant No.	VD28FAD	VQYP8B2	V5SVXPH
Phase cable end	KKH 20 SK	KKH 20 SK	KKH 20 SK
For fixed ball point Ø	20 mm	20 mm	20 mm
Cable cross-section Cu	50/25 mm ²	70/35 mm ²	95/35 mm ²
Max. short-circuit current I _k 0.5 s	14.0 kA	19.5 kA	26.5 kA
Max. short-circuit current I _k 1 s	9.9 kA	13.8 kA	18.7 kA
Type	EKV3+1 120 R VTSY9XH	EKV3+1 150 R VHBWUNH	
Variant No.	VTSY9XH	VHBWUNH	
Phase cable end	KKH 20 SK	KKH 25 SK	
For fixed ball point Ø	20 mm	25 mm	
Cable cross-section Cu	120/50 mm ²	150/50 mm ²	
Max. short-circuit current I _k 0.5 s	33.5 kA	42.0 kA	
Max. short-circuit current I _k 1 s	23.7 kA	29.6 kA	

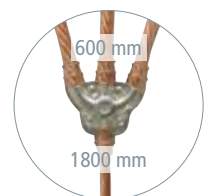
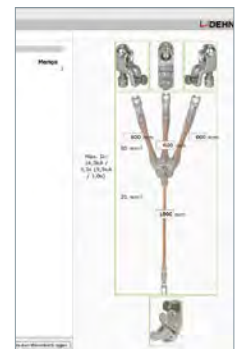

4. Carry out Earthing and Short-Circuiting – EaS Devices



Three-pole, same Cable Cross-Section with Universal Clamp

... easy configuration ...

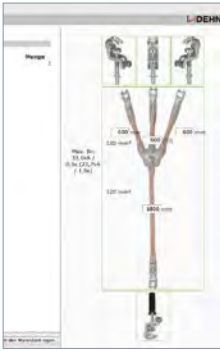

General Information:

Phase cable end	UK 25 SQ
Earth cable end	UEK 25 HG
For fixed ball point Ø	20 / 25 mm
For T pins with a collar width of	15 mm
Rd / Fl clamping range	20 mm

Type	EKV3+1 16 G V8MCNWM	EKV3+1 25 G V8VF7CP	EKV3+1 35 G V5VN56Z	EKV3+1 50 G VPH98CT
Variant No.	V8MCNWM	V8VF7CP	V5VN56Z	VPH98CT
Cable cross-section Cu	16 mm ²	25 mm ²	35 mm ²	50 mm ²
Max. short-circuit current I _k 0.5 s	4.5 kA	7.0 kA	10.0 kA	14.0 kA
Max. short-circuit current I _k 1 s	3.2 kA	4.9 kA	6.9 kA	9.9 kA

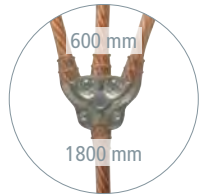

Type	EKV3+1 70 G VMLM2BZ	EKV3+1 95 G VE9HQHJ	EKV3+1 120 G VKZLVU3
Variant No.	VMLM2BZ	VE9HQHJ	VKZLVU3
Cable cross-section Cu	70 mm ²	95 mm ²	120 mm ²
Max. short-circuit current I _k 0.5 s	19.5 kA	26.5 kA	33.5 kA
Max. short-circuit current I _k 1 s	13.8 kA	18.7 kA	23.7 kA



Three-pole, reduced Cable Cross-Section with Universal Clamp

... easy configuration ...

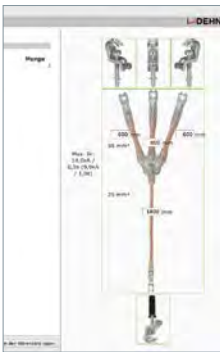

Type	EKV3+1 50 R VMBDCM1	EKV3+1 70 R V4RJ7A2	EKV3+1 95 R VRAB9WB	EKV3+1 120 R VACNLP8
Variant No.	VMBDCM1	V4RJ7A2	VRAB9WB	VACNLP8
Phase cable end	UK 25 SQ	UK 25 SQ	UK 25 SQ	UK 25 SQ
Earth cable end	UEK 25 HG	UEK 25 HG	UEK 25 HG	UEK 25 HG
For fixed ball point Ø	20 / 25 mm	20 / 25 mm	20 / 25 mm	20 / 25 mm
For T pins with a collar width of	15 mm	15 mm	15 mm	15 mm
Rd / Fl clamping range	20 mm	20 mm	20 mm	20 mm
Cable cross-section Cu	50/25 mm ²	70/35 mm ²	95/35 mm ²	120/50 mm ²
Max. short-circuit current I _k 0.5 s	14.0 kA	19.5 kA	26.5 kA	33.5 kA
Max. short-circuit current I _k 1 s	9.9 kA	13.8 kA	18.7 kA	23.7 kA

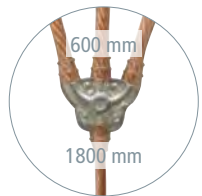

4. Carry out Earthing and Short-Circuiting – EaS Devices

Single-pole with Phase Screw Clamp

... easy configuration ...



Type	EKV1+1 16 VE5E8FZ	EKV1+1 25 VF33XR2	EKV1+1 35 V43FCV8	EKV1+1 50 V2KWXUL
Variant No.	VE5E8FZ	VF33XR2	V43FCV8	V2KWXUL
Phase cable end	PSK 4 30 SQL	PSK 4 30 SQL	PSK 4 30 SQL	PSK 4 30 SQL
Earth cable end	EFK FL40 SKN	EFK FL40 SKN	EFK FL40 SKN	EFK FL40 SKN
Clamping range Ø	4 ... 30 mm	4 ... 30 mm	4 ... 30 mm	4 ... 30 mm
Cable cross-section Cu	16 mm ²	25 mm ²	35 mm ²	50 mm ²
Max. short-circuit current I _k 0.5 s	4.5 kA	7.0 kA	10.0 kA	14.0 kA
Max. short-circuit current I _k 1 s	3.2 kA	4.9 kA	6.9 kA	9.9 kA

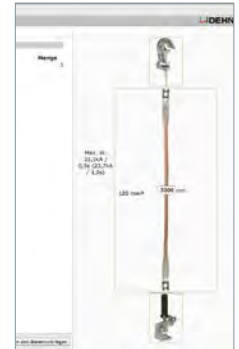

Type	EKV1+1 70 VRP32FL	EKV1+1 95 V2WPHYVF	EKV1+1 120 VG4GXHQ
Variant No.	VRP32FL	V2WPHYVF	VG4GXHQ
Phase cable end	PSK 4 30 SQL	PSK 10 65 SQL	PSK 10 65 SQL
Earth cable end	EFK FL40 SKN	UEK 30 HG	UEK 30 HG
Clamping range Ø	4 ... 30 mm	10 ... 65 mm	10 ... 65 mm
Cable cross-section Cu	70 mm ²	95 mm ²	120 mm ²
Max. short-circuit current I _k 0.5 s	19.5 kA	26.5 kA	33.5 kA
Max. short-circuit current I _k 1 s	13.8 kA	18.7 kA	23.7 kA



Single-pole with Universal Clamp

... easy configuration ...



General Information:	
Phase cable end	UK 25 SQ
Earth cable end	UEK 30 HG
For fixed ball point Ø	20 / 25 mm
For T pins with a collar width of	15 mm
Rd / Fl clamping range	20 mm

Type	EKV1+1 16 VMZDL8N	EKV1+1 25 VB1DETL	EKV1+1 35 V8PPJEF	EKV1+1 50 VQY44GL
Variant No.	VMZDL8N	VB1DETL	V8PPJEF	VQY44GL
Cable cross-section Cu	16 mm ²	25 mm ²	35 mm ²	50 mm ²
Max. short-circuit current I _k 0.5 s	4.5 kA	7.0 kA	10.0 kA	14.0 kA
Max. short-circuit current I _k 1 s	3.2 kA	4.9 kA	6.9 kA	9.9 kA

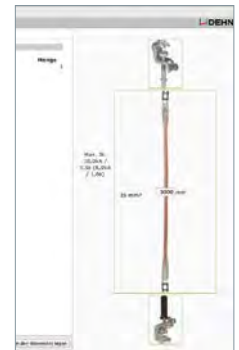

Type	EKV1+1 70 VFZ17TJ	EKV1+1 95 VWBDMPS	EKV1+1 120 V3CM9FR
Variant No.	VFZ17TJ	VWBDMPS	V3CM9FR
Cable cross-section Cu	70 mm ²	95 mm ²	120 mm ²
Max. short-circuit current I _k 0.5 s	19.5 kA	26.5 kA	33.5 kA
Max. short-circuit current I _k 1 s	13.8 kA	18.7 kA	23.7 kA



4. Carry out Earthing and Short-Circuiting – EaS Devices

Kits for Railway Applications

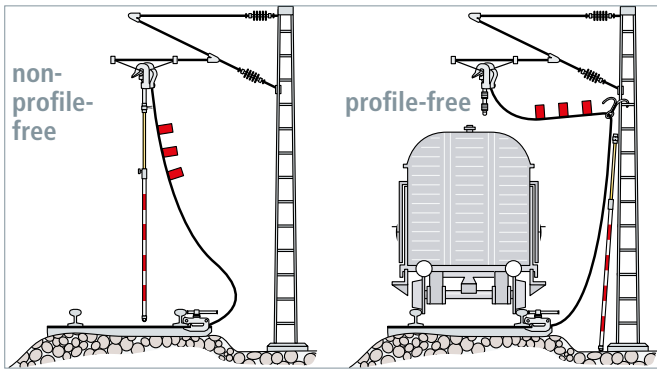

Parts list:			
Pos.	Part No.	Pos.	Part No.
1	784 755	10	751 150
2	773 251	11	740 124
3	784 352	12	769 502
4	792 450	13	769 508
5	792 453	14	769 506
6	774 251	15	769 352
7	751 085	16	761 015
8	751 120	17	785 111
9	751 040	18	700 000

General Information:

Standard	EN/IEC 61230 (DIN VDE 0683-100)
Temperature range	-25 °C ... +55 °C

Kit for Overhead Contact Lines (non-profile-free)

Telescopic earthing stick with adjusting ring (max. 5 m long)

Kit includes:		
Type	Part No.	Pos. No.
Tommy bar (K) or ratchet (R)		
EKV K 50 8500	1x 751 086	1+4+7
EKV R 50 8500	1x 751 087	1+5+7
ESTC SQL RW 5000	1x 769 502	12

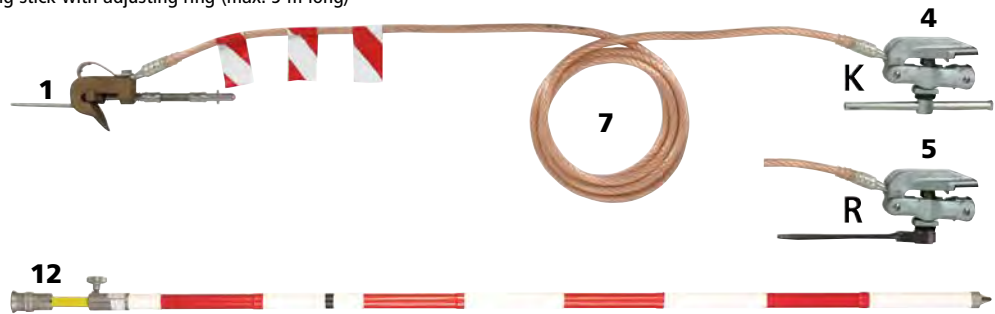

Type BEV ...	OL NPF K	OL NPF R
Part No.	750 210	750 218
Design	Tommy bar	Ratchet
Cable cross-section	50 mm ²	50 mm ²
Cable length	8500 mm	8500 mm
Max. short-circuit current I _k 0.06 s	34.0 kA	34.0 kA
DB drawing No.	3 Ebgw 01.51	—
DB material No.	237 117	—

Kit for Overhead Contact Lines for Transport in Motor Vehicles (non-profile-free)

For technical emergency service and emergency management

Telescopic earthing stick kit consisting of six elements, pluggable (max. 5 m long).

Kit includes:		
Type	Part No.	Pos. No.
Tommy bar (K) or ratchet (R)		
EKV K 50 8500	2x 751 086	1+4+7
EKV R 50 8500	2x 751 087	1+5+7
EST SQL RW 4915 TA	1x 769 506	14
STT 55 27 30	1x 785 111	17



Type BEV ...	OL NPF PKW K	OL NPF PKW R
Part No.	750 196	750 216
Design	Tommy bar	Ratchet
Cable cross-section	50 mm ²	50 mm ²
Cable length	8500 mm	8500 mm
Max. short-circuit current I _k 0.06 s	34.0 kA	34.0 kA
DB drawing No.	3 Ebgw 01.67	—
DB material No.	237 125	—

4. Carry out Earthing and Short-Circuiting – EaS Devices

Kit for Overhead Contact Lines (profile-free *)

Telescopic earthing stick with adjusting ring (max. 5 m long).

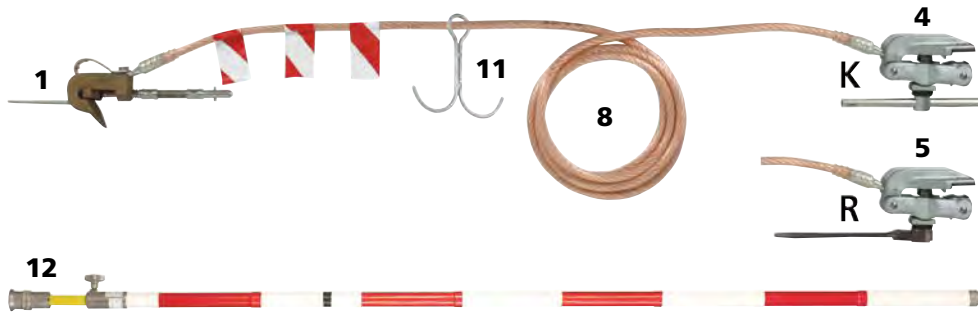

Kit includes:		
Type	Part No.	Pos. No.
Tommy bar (K) or ratchet (R)		
EKV K H 50 12000	1x 751 121	1+4+8+11
EKV R H 50 12000	1x 751 122	1+5+8+11
ESTC SQL RW 5000	1x 769 502	12

Type BEV ...	OL PF K	OL PF R
Part No.	750 211	750 219
Design	Tommy bar	Ratchet
Cable cross-section	50 mm ²	50 mm ²
Cable length	12000 mm	12000 mm
Max. short-circuit current I_k 0.06 s	34.0 kA	34.0 kA
DB drawing No.	3 Ebgw 01.51	—
DB material No.	237 118	—

*) Profile-free earthing means that the earthing cable can be suspended on the tower thus allowing for limited diesel locomotive operation.

Kit for Overhead Contact Lines (profile-free *)

Telescopic earthing stick with cable entry and suspension hook (max. 5 m long).

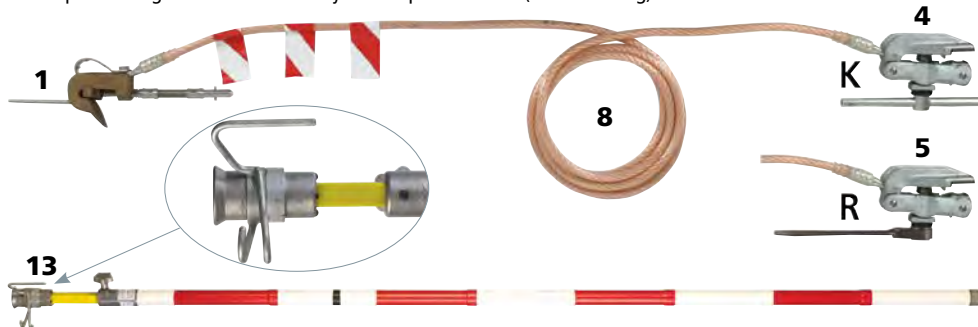

Kit includes:		
Type	Part No.	Pos. No.
Tommy bar (K) or ratchet (R)		
EKV K 50 12000	1x 751 126	1+4+8
EKV R 50 12000	1x 751 127	1+5+8
ESTC SQL H RW 5000	1x 769 508	13

Type BEV ...	OL PF V2 K	OL PF V2 R
Part No.	750 214	750 221
Design	Tommy bar	Ratchet
Cable cross-section	50 mm ²	50 mm ²
Cable length	12000 mm	12000 mm
Max. short-circuit current I_k 0.06 s	34.0 kA	34.0 kA
DB drawing No.	3 Ebgw 01.51	—
DB material No.	237 115	—

*) Profile-free earthing means that the earthing cable can be suspended on the tower thus allowing for limited diesel locomotive operation.

4. Carry out Earthing and Short-Circuiting – EaS Devices

Kit for Overhead Contact Lines for Transport in Motor Vehicles (profile-free *)

For technical emergency service and emergency management

Telescopic earthing stick kit consisting of six elements, pluggable (max. 5 m long).



Kit includes:		
Type	Part No.	Pos. No.
Tommy bar (K) or ratchet (R)		
EKV K H 50 12000	2x 751 121	1+4+8+11
EKV R H 50 12000	2x 751 122	1+5+8+11
EST SQL RW 4915 TA	2x 769 506	14
STT 55 27 30	1x 785 111	17

Type BEV ...	OL PF PKW K	OL PF PKW R
Part No.	750 200	750 217
Design	Tommy bar	Ratchet
Cable cross-section	50 mm ²	50 mm ²
Cable length	12000 mm	12000 mm
Max. short-circuit current I _k 0.06 s	34.0 kA	34.0 kA
DB drawing No.	3 Ebgw 01.67	—

* Profile-free earthing means that the earthing cable can be suspended at the tower, thus allowing for limited diesel locomotive operation.

Kit for Transformers at Overhead Line Towers

For earthing on fuse carriers

Telescopic earthing stick with adjusting ring (max. 3.5 m long).

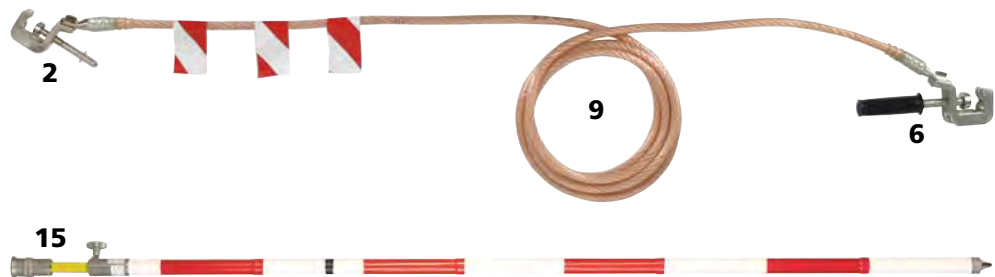

Kit includes:		
Type	Part No.	Pos. No.
EKV UK 50 4000	2x 750 041	2+6+9
ESTC SQL RW 3500	1x 769 352	15

Type BEV ...	US OL ST
Part No.	750 212
Cable cross-section	50 mm ²
Cable length	4000 mm
Max. short-circuit current I _k 0.06 s	34.0 kA
DB drawing No.	3 Ebgw 01.57
DB material No.	237 121

4. Carry out Earthing and Short-Circuiting – EaS Devices

Kit for Supply Lines, Line Feeders, Bypass Lines and other Types of Lines

For earthing the supply line and traction current lines

Telescopic earthing stick with adjusting ring (max. 3.5 m long).

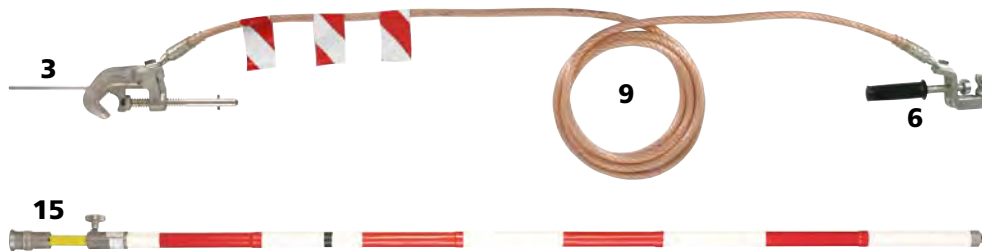

Kit includes:		
Type	Part No.	Pos. No.
EKV LK 50 4000	1x 750 042	3+6+9
ESTC SQL RW 3500	1x 769 352	15

Type BEV ...	SVUL
Part No.	750 213
Cable cross-section	50 mm ²
Cable length	4000 mm
Max. short-circuit current I_k 0.06 s	34.0 kA
DB drawing No.	3 Ebgw 01.57
DB material No.	237 119

Kit for Electric Point and Train Pre-Heating Systems

For the initial equipment of a transformer of electric point and train pre-heating systems.

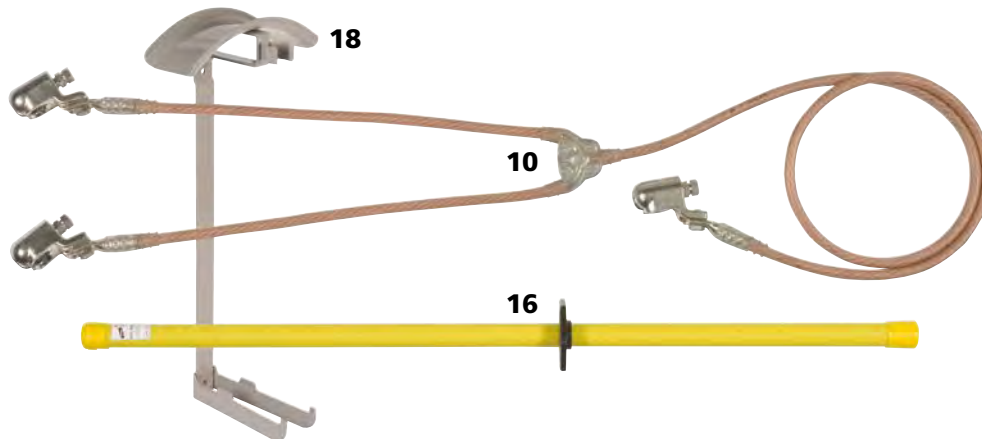

Kit includes:		
Type	Part No.	Pos. No.
EKV2 50 KKH 600 1800	2x 751 150	10
ES SK 1500	1x 761 015	16
HV EKV ES30	1x 700 000	18

Type BEV ...	WHA ZVA
Part No.	750 215
Cable cross-section	50 mm ²
Cable length	600 / 1800 mm
Max. short-circuit current I_k 0.06 s	34.0 kA
DB drawing No.	3 Ebgw 01.70
DB material No.	742 402

For voltage detectors for electric point heating systems, please refer to the PHE voltage detector chapter.

4. Carry out Earthing and Short-Circuiting – EaS Devices

Earthing and Short-Circuiting Devices for Railway Applications

Parts list:			
Pos.	Part No.	Pos.	Part No.
1	Cu 784 755	7	Cu 751 085
1	Al 784 756	7	Al 752 085
2	773 251	8	Cu 751 120
3	784 352	8	Al 752 120
4	Cu 792 450	9	Cu 751 040
4	Al 792 451	9	Al 752 040
5	Cu 792 453	10	750 202
5	Al 792 454	11	740 124
6	774 251		



General Information:

Standard	EN/IEC 61230 (DIN VDE 0683-100) and IEC 61138
Temperature range	- 25 °C ... + 55 °C

With Earth Clamp for Overhead Contact Lines and Clamp for Railway Tracks with Tommy Bar



Type	EKV K 50 8500	EKV K 50 12000	EKV K H 50 12000
Part No.	751 086	751 126	751 121
Material (cable)	Cu	Cu	Cu
Cable cross-section	50 mm ²	50 mm ²	50 mm ²
Cable length	8500 mm	12000 mm	12000 mm
Hook	—	—	✓
Max. short-circuit current I _k 0.06 s	34.0 kA	34.0 kA	34.0 kA
DB drawing No.	3 Ebgw 01.51/67	3 Ebgw 01.51/67	3 Ebgw 01.51/67

Type	EKV FD K 70 8500AL	EKV FD K 70 12000AL	EKV FD K H70 12000AL
Part No.	752 086	752 126	752 121
Material (cable)	Al	Al	Al
Cable cross-section	70 mm ²	70 mm ²	70 mm ²
Cable length	8500 mm	12000 mm	12000 mm
Hook	—	—	✓
Max. short-circuit current I _k 0.06 s	32.0 kA	32.0 kA	32.0 kA
DB drawing No.	Ebgw 01.74	Ebgw 01.74	Ebgw 01.79

With Earth Clamp for Overhead Contact Lines and Clamp for Railway Tracks with Ratchet



Type	EKV R 50 8500	EKV R 50 12000	EKV R H 50 12000
Part No.	751 087	751 127	751 122
Material (cable)	Cu	Cu	Cu
Cable cross-section	50 mm ²	50 mm ²	50 mm ²
Cable length	8500 mm	12000 mm	12000 mm
Hook	—	—	✓
Max. short-circuit current I _k 0.06 s	34.0 kA	34.0 kA	34.0 kA
DB drawing No.	3 Ebgw 01.51/67	3 Ebgw 01.51/67	3 Ebgw 01.51/67

Type	EKV FD R 70 8500AL	EKV FD R 70 12000AL	EKV FD R H70 12000AL
Part No.	752 087	752 127	752 122
Material (cable)	Al	Al	Al
Cable cross-section	70 mm ²	70 mm ²	70 mm ²
Cable length	8500 mm	12000 mm	12000 mm
Hook	—	—	✓
Max. short-circuit current I _k 0.06 s	32.0 kA	32.0 kA	32.0 kA
DB drawing No.	Ebgw 01.78	Ebgw 01.78	Ebgw 01.80

4. Carry out Earthing and Short-Circuiting – EaS Devices

With Universal Clamp (T Pin Shaft) and Universal Clamp (Handle)

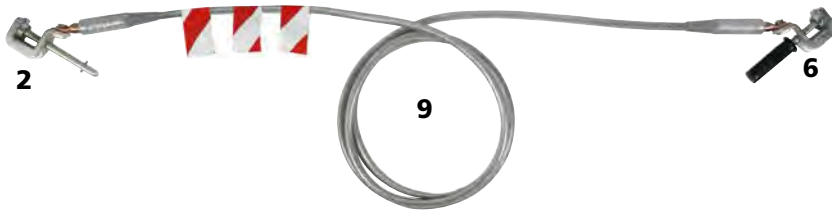

Type	EKV UK 50 4000	EKV UKQ UKH70 4000AL
Part No.	750 041	752 041
Material (cable)	Cu	Al
Cable cross-section	50 mm ²	70 mm ²
Cable length	4000 mm	4000 mm
Max. short-circuit current I_k 0.06 s	34.0 kA	32.0 kA
DB drawing No.	3 Ebgw 01.57	Ebgw 01.73

With Conductor Clamp and Universal Clamp (Handle)



Type	EKV LK 50 4000	EKV LK UKH 70 4000AL
Part No.	750 042	752 042
Material (cable)	Cu	Al
Cable cross-section	50 mm ²	70 mm ²
Cable length	4000 mm	4000 mm
Max. short-circuit current I_k 0.06 s	34.0 kA	32.0 kA
DB drawing No.	3 Ebgw 01.57	Ebgw 01.77

With Ball Head Caps (Ø25 mm)

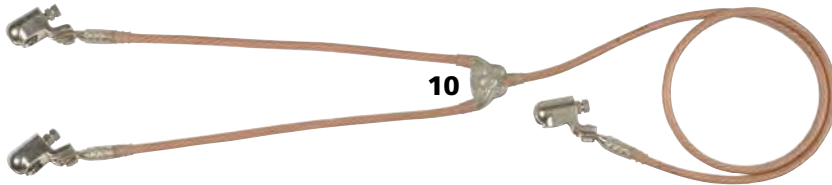

Type	EKV2 50 KKH 600 1800
Part No.	751 150
Material (cable)	Cu
Cable cross-section	50 mm ²
Cable length	600 / 1800 mm
Max. short-circuit current I_k 0.06 s	34.0 kA
DB drawing No.	3 Ebgw 01.70
DB material No.	742 400

With Universal Clamp (Handle) and Clamp for Railway Tracks with Tommy Bar



Type	BEV MF SE K	BEV BM HZ BDW K	BEV UKH K 70 8500AL	BEV UKH K 70 12000AL
Part No.	751 191	751 193	752 191	752 193
Material (cable)	Cu	Cu	Al	Al
Cable cross-section	50 mm ²	50 mm ²	70 mm ²	70 mm ²
Cable length	8500 mm	12000 mm	8500 mm	12000 mm
Max. short-circuit current I_k 0.06 s	34.0 kA	34.0 kA	32.0 kA	32.0 kA
DB drawing No.	3 Ebgw 01.56	3 Ebgw 01.56	Ebgw 01.75	Ebgw 01.75

4. Carry out Earthing and Short-Circuiting – EaS Devices

With Universal Clamp (Handle) and Clamp for Railway Tracks with Ratchet

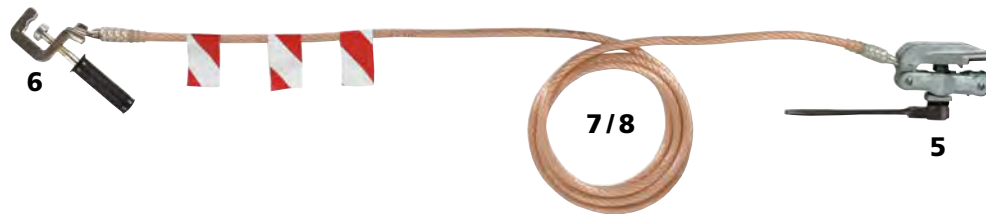

Type	BEV MF SE R	BEV BM HZ BDW R	BEV UKH R 70 8500AL	BEV UKH R 70 12000AL
Part No.	751 196	751 197	752 196	752 197
Material (cable)	Cu	Cu	Al	Al
Cable cross-section	50 mm ²	50 mm ²	70 mm ²	70 mm ²
Cable length	8500 mm	12000 mm	8500 mm	12000 mm
Max. short-circuit current I _k 0.06 s	34.0 kA	34.0 kA	32.0 kA	32.0 kA
DB drawing No.	3 Ebgw 01.56	3 Ebgw 01.56	Ebgw 01.76	Ebgw 01.76

With Universal Clamps (Handle) on both sides

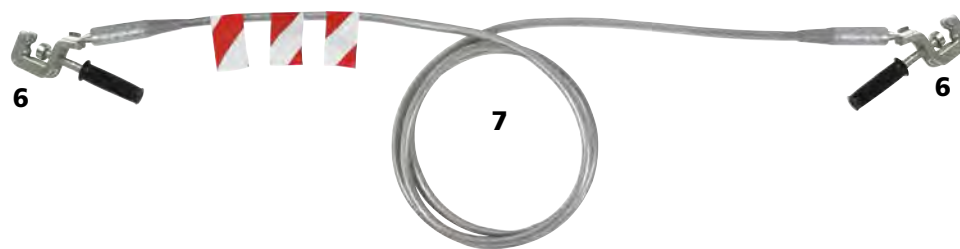

Type	BEV MF LTE	BEV 2XUKH 70 8500AL
Part No.	751 192	752 192
Material (cable)	Cu	Al
Cable cross-section	50 mm ²	70 mm ²
Cable length	8500 mm	8500 mm
Max. short-circuit current I _k 0.06 s	34.0 kA	32.0 kA
DB drawing No.	3 Ebgw 01.56	Ebgw 01.72

Accessories for Earthing and Short-Circuiting Devices for Railway Applications

Single-pole earthing and short-circuiting cable, unequipped

With red and white marking and cable lug with borehole Ø10.5 mm.

General Information:

Crimped cable lug PK2 (Ø10.5 mm)



Type	EKS 50 BEV 4M	EKS 50 BEV 8.5M	EKS 50 BEV 12M	EKS 50 BEV 13M	EKS 50 BEV 14M
Part No.	751 040	751 085	751 120	751 130	751 140
Material	Cu	Cu	Cu	Cu	Cu
Cable cross-section	50 mm ²	50 mm ²	50 mm ²	50 mm ²	50 mm ²
Cable length	4000 mm	8500 mm	12000 mm	13000 mm	14000 mm
DB material No.	157 511	157 512	157 513	—	—

Type	EKS B10.5 70 4000AL	EKS B10.5 70 8500AL	EKS B10.5 70 12000AL
Part No.	752 040	752 085	752 120
Material	Al	Al	Al
Cable cross-section	70 mm ²	70 mm ²	70 mm ²
Cable length	4000 mm	8500 mm	12000 mm

Suspension hook

For (profile-free) suspension of earthing cables on towers.



Type	EHH BEV OL
Part No.	740 124
DB material No.	778 794

4. Carry out Earthing and Short-Circuiting – EaS Devices

Short-Circuiting Bar: Easy online configuration

- Easy online selection of the short-circuiting bar
- Individual configuration
- Permanent plausibility check in the background
- With longitudinal slot for reliable contact
- For copper or aluminium busbars up to a thickness of 25 mm
- For use with earthing sticks for hexagon or T pin shafts
- Other bar and earthing cable lengths can be selected online via the earthing and short-circuiting configurator

General Information:

Standard	EN/IEC 61230 (DIN VDE 0683-100)
Temperature range	-25 °C ... +55 °C
Profile	60 x 8 mm; 60 x 12 mm
Material (earthing cable)	Highly flexible copper
Cable cross-section	50 mm ²



Short-circuiting bar with earthing cable on a switchgear installation.



EaS Configurator:
www.dehn.de/en/euk

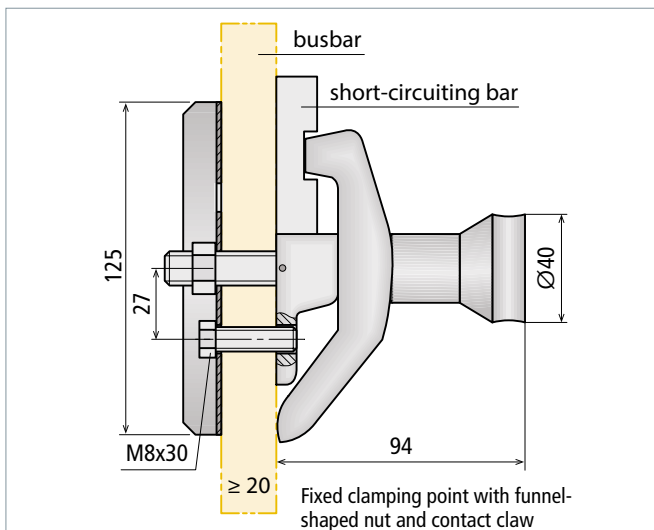

The short-circuiting bar with longitudinal slot can be used for installations without direct neutral point earthing. The earthing cable must be equipped with a connecting element for connection to the earthing system. Other cable lengths or equipment can be selected online via the EaS Configurator. Short-circuiting bars are available with two different coupling mechanisms for earthing sticks:



SK: Hexagon shaft.



SQ: T pin shaft (bayonet locking mechanism).



Short-circuiting bar made of copper (E-Cu F20)

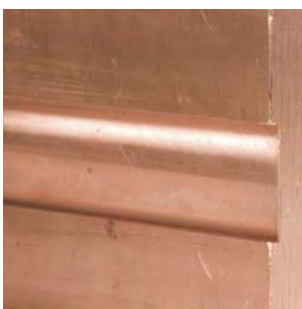

Short-circuiting bar made of aluminum (AlMgSi 0,5)

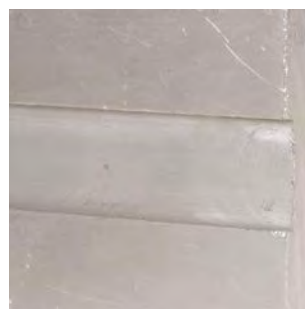

Two coupling mechanisms are required for a total length > 1000 mm.

Note: When ordering, please specify the Variant No. generated online via the earthing and short-circuiting configurator

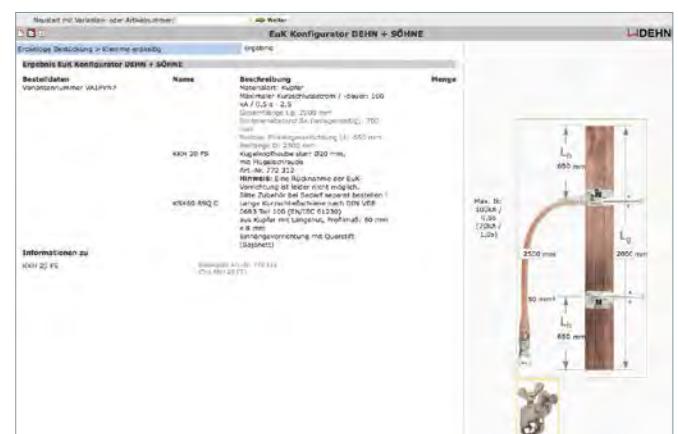

You will find the EaS configurator and a demo version at

www.dehn.de/en/euk

4. Carry out Earthing and Short-Circuiting – EaS Devices

Accessories for Short-Circuiting Bar

**Fixed clamping point for busbars**

Fixed clamping point with fixing elements for a busbar thickness up to 25 mm and contact claw for short-circuiting bars with longitudinal slot.

Type	KLFP M12 KSS
Part No.	795 040
Type	Threaded shaft with aluminium funnel-shaped nut

SK Screw-type adapter

Screw-type adapter to be plugged into earthing sticks for tightening/loosening the funnel-shaped nut of the fixed clamping point. Hexagon shaft (width across flats 19).



Type	SA KLFP SK
Part No.	795 214
Total length (l _c)	60 mm
Width A/F	19 mm

**SQ Screw-type adapter**

Screw-type adapter to be plugged into earthing sticks for tightening/loosening the funnel-shaped nut of the fixed clamping point. T pin shaft (bayonet coupling mechanism).

Type	SA KLFP SQ
Part No.	795 213
Total length (l _c)	100 mm

4. Carry out Earthing and Short-Circuiting – EaS Devices

Earthing and Short-Circuiting Devices (fully insulated) for Low-Voltage Cable Distribution Cabinets

Kit for low-voltage installations, fully insulated type VI

- Fully insulated, shock-proof version
- Fully equipped kit for cable distribution cabinets
- Safe operation with insulated earthing handle of type VI (with dual function), suitable for both inserting and removing earthing cartridges with T connection as well as for attaching earthing and short-circuiting devices (EaS devices)
- Waterproof, plastic-sheathed cable entries and node unit, with additional anti-kink protection
- Other cable lengths can be selected online via the earthing and short-circuiting configurator

General Information:

Standard	EN/IEC 61230 (DIN VDE 0683-100)
Temperature range	-25 °C ... +55 °C

EaS Configurator:
www.dehn.de/en/euk



Attaching a fully insulated earthing and short-circuiting device using an earthing handle of type VI

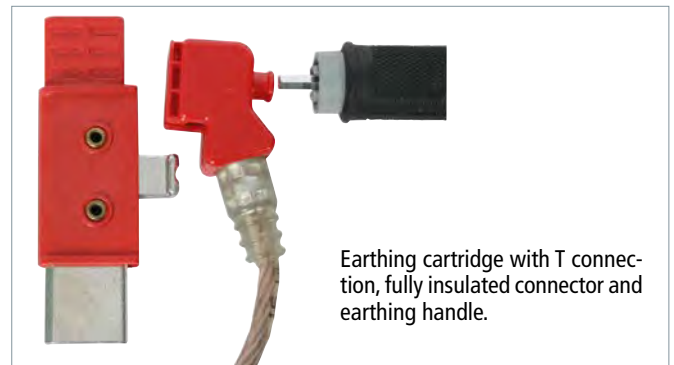

Earthing cartridge with T connection, fully insulated connector and earthing handle.

Kit in Plastic Case

Type EKS VI 2F KVS ...	KK
Part No.	745 903
Variant No. of EaS device	V162LDM
Dimensions	450 x 350 x 110 mm

Attention: Please state the relevant Variant No. when ordering.



Kit includes:

Pos.	Part No.	Pos.	Part No.
1	1x 745 902	5	6x 745 910
3	2x V162LDM	6	1x 745 922
4	3x 745 905		

For more detailed information on these products, see Single Parts.

Kit in Sheet Steel Case

Type EKS VI 2F KVS ...	SBK
Part No.	745 901
Variant No. of EaS device	V162LDM
Dimensions	440 x 330 x 100 mm

Attention: Please state the relevant Variant No. when ordering.



Kit includes:

Pos.	Part No.	Pos.	Part No.
2	1x 745 900	5	6x 745 910
3	2x V162LDM	6	1x 745 922
4	3x 745 905		

For more detailed information on these products, see Single Parts.

4. Carry out Earthing and Short-Circuiting – EaS Devices

Single Parts and Accessories for EaS Devices (fully insulated) for Low-Voltage Cable Distribution Cabinets



1

Plastic case, empty

With foam padding.

Type	KKL EKS VI KVS
Part No.	745 902
Dimensions	450 x 350 x 110 mm



2

Sheet steel case, empty

With foam padding.

Type	SBKL EKS VI KVS
Part No.	745 900
Dimensions	440 x 330 x 100 mm

**Plastic case, empty**

With foam padding and hook-and-loop fastener.

Type	KK 56 41 17 EK VI TI
Part No.	745 952
Dimensions	565 x 410 x 170 mm

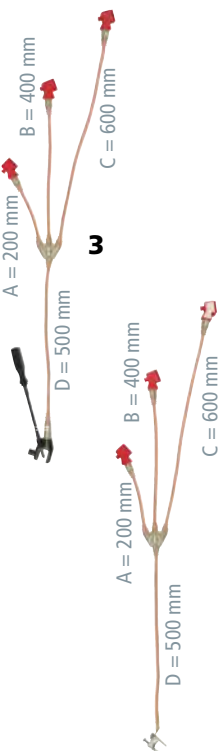

3

Earthing and short-circuiting device VI, earth clamp with flexible adjustable handleAdjustable handle with two positions, clamping range up to 20 mm.
For cable distribution cabinets.

Type	EKV3 25VI DG V162LDM	EKV3 35VI DG VE5K3HM
Variant No.	V162LDM	VE5K3HM
Cable cross-section Cu	25/25 mm ²	35/35 mm ²
Max. short-circuit current I _k 0.5 s	7.0 kA	10.0 kA
Max. short-circuit current I _k 1 s	4.9 kA	6.9 kA

Note: When ordering, please specify a clear Variant No.

Earthing and short-circuiting device VI, spring-loaded earth clampClamping range up to 24 mm, installation via adjustable handle DGF EKV VI.
For cable distribution cabinets.

Type	EKV3 25VI EK VMRSJWD	EKV3 35VI EK VEH4JQY
Variant No.	VMRSJWD	VEH4JQY
Cable cross-section Cu	25/25 mm ²	35/35 mm ²
Max. short-circuit current I _k 0.5 s	7.0 kA	10.0 kA
Max. short-circuit current I _k 1 s	4.9 kA	6.9 kA

Note: Please state the relevant Variant No. when ordering.

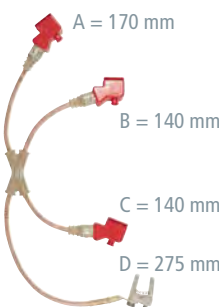
**Earthing and short-circuiting device VI, spring-loaded earth clamp**Clamping range up to 24 mm, attachment via adjustable handle DGF EKV VI.
For service entrance boxes.

Type	EKV3 16VI EK VZPW9LG
Variant No.	VZPW9LG
Cable cross-section Cu	16/16 mm ²
Max. short-circuit current I _k 0.5 s	4.5 kA
Max. short-circuit current I _k 1 s	3.2 kA

Note: When ordering, please specify a clear Variant No.

4. Carry out Earthing and Short-Circuiting – EaS Devices

Single Parts and Accessories for EaS Devices (fully insulated) for Low-Voltage Cable Distribution Cabinets

Spring-loaded compact clamp

With T connection and hexagon locking screw (WS10) for use with earthing handle VI and fixing via adjustable handle with flexible shaft.

Type	KK TA 0 24 SK10
Part No.	745 503
Clamping range	Up to 24 mm
Max. short-circuit current I_k 0.5 s	10.0 kA
Max. short-circuit current I_k 1 s	6.9 kA



Earthing adapter clamp for blade contacts

The earthing adapter clamp is particularly suitable for short-circuiting the LV blade contacts in NH fuse strips having a blade width of 33 or 44 mm and a blade depth of 6 and 8 mm.

With T connection and hexagon locking screw WS10.

To be inserted by means of an earthing handle VI and to be fixed by means of an adjustable handle with flexible shaft.

Type	EK SN7089
Part No.	745 510
for blade contact	33 / 44 mm
Max. short-circuit current I_k 0.5 s	10.0 kA
Max. short-circuit current I_k 1 s	6.9 kA



NH 00 Earthing cartridges

With T connection for installation into NH fuse holders and blocks of size NH 00 using a VI earthing handle.

Type	EP NH00 VI TA
Part No.	745 905
Size	00
Max. cable cross-section Cu	35 mm ²
Max. short-circuit current I_k 0.5 s	4.9 kA
Max. short-circuit current I_k 1 s	4.9 kA



NH 1 ... 3 Earthing cartridges

With T connection for installation into NH fuse holders and blocks of size NH 1 ... 3 using a VI earthing handle.

Type	EP NH1 3 VI TA
Part No.	745 910
Size	1 ... 3
Max. cable cross-section Cu	35 mm ²
Max. short-circuit current I_k 0.5 s	9.6 kA
Max. short-circuit current I_k 1 s	6.9 kA



NH 4a Earthing cartridges

Type	EP NH4A VI TA
Part No.	745 915
Size	4a
Max. cable cross-section Cu	35 mm ²
Max. short-circuit current I_k 0.5 s	10.0 kA
Max. short-circuit current I_k 1 s	6.9 kA



VI Earthing handle

With dual function

- For installing earthing cartridges with T connection into NH fuse holders
- For connecting VI earthing and short-circuiting devices to earthing cartridges

Type	EG 00 4A VI
Part No.	745 922
Length	285 mm



Rotary handle with flexible shaft

With magnetic socket wrench insert.

For connecting spring-loaded earth clamps.

Type	DGF EKV VI
Part No.	745 921
Length	290 mm



4. Carry out Earthing and Short-Circuiting – EaS Devices

Earthing and Short-Circuiting Devices (partly insulated) for Low-Voltage Cable Distribution Cabinets



Attaching a partly insulated earthing and short-circuiting device using an earthing handle of type TI



- Kit for low-voltage installations, partly insulated type TI
- Fully equipped kit for cable distribution cabinets
- Safe operation with insulated earthing handle of type TI (with dual function), suitable both for installing and removing earthing cartridges with M10 connection as well as for attaching earthing and short-circuiting devices (EaS devices)
- Waterproof, plastic-sheathed cable entries and node unit, with additional anti-kink protection
- Other cable lengths can be selected online via the earthing and short-circuiting configurator



Earthing cartridge with M10 connection, partly insulated connector and earthing handle.

General Information:

Standard	EN/IEC 61230 (DIN VDE 0683-100)
Temperature range	-25 °C ... +55 °C

Kit I in Sheet Steel Case

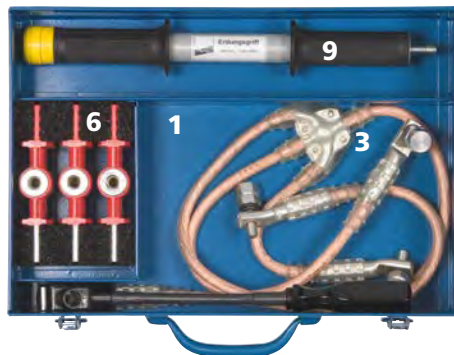

Kit includes:

Pos.	Part No.	Pos.	Part No.
1	1x 766 300	6	3x 745 018
3	1x VSUN6NV	9	1x 745 400

For more detailed information on these products, see Single Parts.

Type EKS TI ...	KVS SBK
Part No.	766 302
Variant No. of EaS device	VSUN6NV
Dimensions	380 x 260 x 80 mm

Attention: Please state the relevant Variant No. when ordering.

Kit II in Sheet Steel Case

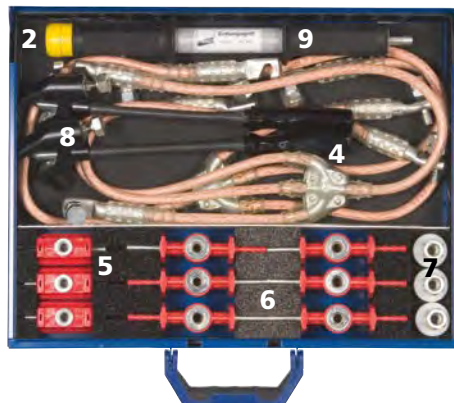

Kit includes:

Pos.	Part No.	Pos.	Part No.
2	1x 766 298	7	3x 745 202
4	2x VUKMT58	8	2x 745 602
5	3x 745 302	9	1x 745 400
6	6x 745 018		

For more detailed information on these products, see Single Parts.

Type EKS TI ...	2F KVS SBK
Part No.	745 500
Variant No. of EaS device	VUKMT58
Dimensions	440 x 330 x 66 mm

Attention: Please state the relevant Variant No. when ordering.

4. Carry out Earthing and Short-Circuiting – EaS Devices

Single Parts and Accessories for EaS Devices (partly insulated) for Low-Voltage Cable Distribution Cabinets

Sheet steel case, empty

Type	SBKL EKS TI KVS
Part No.	766 300
Dimensions	380 x 260 x 80 mm



Sheet steel case, empty

With foam padding.

Type	SBKL EKS TI KVS 2F
Part No.	766 298
Dimensions	440 x 330 x 66 mm



Plastic case, empty

With foam padding and hook-and-loop fastener.

Type	KK 56 41 17 EK VI TI
Part No.	745 952
Dimensions	565 x 410 x 170 mm



Earthing and short-circuiting device TI, earth clamp with flexible adjustable handle

Adjustable handle with two positions, clamping range up to 20 mm.
For cable distribution cabinets.

Type	EKV3 25TI DG VSUN6NV	EKV3 35TI DG VSHDQZB
Variant No.	VSUN6NV	VSHDQZB
Cable cross-section Cu	25/25 mm ²	35/35 mm ²
Max. short-circuit current I _k 0.5 s	7.0 kA	10.0 kA
Max. short-circuit current I _k 1 s	4.9 kA	6.9 kA

Note: When ordering, please specify a clear Variant No.

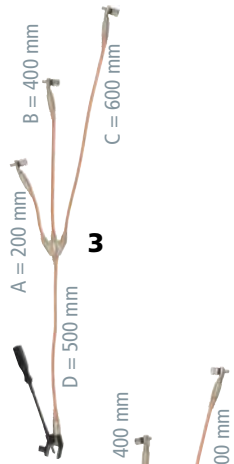

Earthing and short-circuiting device TI, with hook-shaped cable lug on the earth cable end

For installation of earth clamps EK I FL20 DGF or EK FL20 FS.
For cable distribution cabinets.

Type	EKV3 16TI HK V3RQASE	EKV3 25TI HK VUKMT58	EKV3 35TI HK VDZ2VDX
Variant No.	V3RQASE	VUKMT58	VDZ2VDX
Cable cross-section Cu	16/16 mm ²	25/25 mm ²	35/35 mm ²
Max. short-circuit current I _k 0.5 s	4.5 kA	7.0 kA	10.0 kA
Max. short-circuit current I _k 1 s	3.2 kA	4.9 kA	6.9 kA

Note: When ordering, please specify a clear Variant No.



Earthing and short-circuiting device TI, spring-loaded earth clamp

Clamping range up to 24 mm and fixing via adjustable handle DGF EKV VI.
Earthing cartridges of size 00 fixed on the phase cable end.
For service entrance boxes.

Type	EKV3 NH00 TI V1RC3P2
Variant No.	V1RC3P2
Cable cross-section Cu	16/16 mm ²
Max. short-circuit current I _k 0.5 s	4.5 kA
Max. short-circuit current I _k 1 s	3.2 kA

Note: When ordering, please specify a clear Variant No.

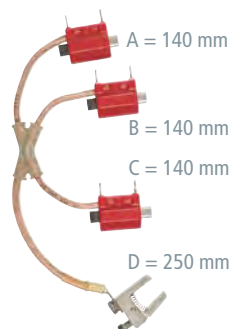

4. Carry out Earthing and Short-Circuiting – EaS Devices

Single Parts and Accessories for EaS Devices (partly insulated) for Low-Voltage Cable Distribution Cabinets

A = 190 mm

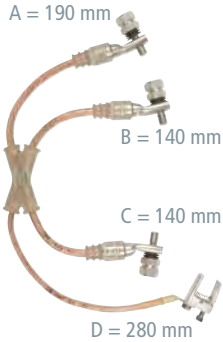

B = 140 mm

C = 140 mm

D = 280 mm

Earthing and short-circuiting device TI, spring-loaded earth clamp

Clamping range up to 24 mm and fixing via adjustable handle DGF EKV VI.
Screw-on cable lugs with M10 hexagon pin on the phase cable end.
To be screwed onto earthing cartridges with M10 connection of service entrance boxes.

Type	EKV3 16TI EK VSB29AH
Variant No.	VSB29AH
Cable cross-section Cu	16/16 mm ²
Max. short-circuit current I _k 0.5 s	4.5 kA
Max. short-circuit current I _k 1 s	3.2 kA

Note: When ordering, please specify a clear Variant No.

NH 00 Earthing cartridges

With M10 connection for insertion into NH fuse holders and blocks of size NH 00 using a TI earthing handle.



5

Type	EP NH00 TI M10
Part No.	745 302
Size	00
Max. cable cross-section Cu	35 mm ²
Max. short-circuit current I _k 0.5 s	4.9 kA
Max. short-circuit current I _k 1 s	4.9 kA

NH 1 ... 3 Earthing cartridges

With M10 connection for insertion into NH fuse holders and blocks of size NH 1 ... 3 using a TI earthing handle.



6

Type	EP NH1 3 TI M10
Part No.	745 018
Size	1 ... 3
Max. cable cross-section Cu	35 mm ²
Max. short-circuit current I _k 0.5 s	9.6 kA
Max. short-circuit current I _k 1 s	6.9 kA

NH 4a Earthing cartridges

With M10 connection for insertion into NH fuse holders and blocks of size NH 4a.



Type	EP NH4A TI M10
Part No.	745 016
Size	4a
Max. cable cross-section Cu	35 mm ²
Max. short-circuit current I _k 0.5 s	10.0 kA
Max. short-circuit current I _k 1 s	6.9 kA

NH 1 ... 3 Earthing cartridges with grip lugs

With M10 connection for use with TI earthing handle or NH fuse handle with sleeve NHS AG 00 3 NS.



Type	EP NH1 3 TI GL M10
Part No.	745 017
Size	1 ... 3
Max. cable cross-section Cu	35 mm ²
Max. short-circuit current I _k 0.5 s	9.6 kA
Max. short-circuit current I _k 1 s	6.9 kA

Adapter

Adapter for earthing cartridges NH 1...3, partly insulated, with M10 connection.
For screwing in by means of earthing handle TI through opening (D_{min} = 11 mm) in the window of NH fuse switch disconnectors.

Type	AD EP TI M10
Part No.	745 022
Material	Ms/gal CuSn
Thread size	M10
Diameter (bolt)	11 mm
Max. short-circuit current I _k 0.5 s	9.6 kA
Max. short-circuit current I _k 1 s	6.9 kA



4. Carry out Earthing and Short-Circuiting – EaS Devices

Single Parts and Accessories for EaS Devices (partly insulated) for Low-Voltage Cable Distribution Cabinets

Contact blade

With M10 connection for insertion by means of earthing handle type TI.

Type	KM AB M10 SN7280
Part No.	745 021
Size	1 ... 3
Max. cable cross-section Cu	35 mm ²
Max. short-circuit current I _k 0.5 s	9.6 kA
Max. short-circuit current I _k 1 s	6.9 kA



Touch protection for earthing cartridges NH 1...3

Type	BS EP NH1 3 TI
Part No.	745 506
Size	NH 1 ... 3
Material	Thermoplastic



Screw-in earthing insert with M10 connection, insulated

Insulated thread.

To be screwed into E27 and E33 threaded fuse holders using a TI earthing handle.

Type	ESE E27 TI M10	ESE E33 TI M10
Part No.	745 201	745 202
Size	E27	E33
Contact pin	Brass/gal CuSn	Brass/gal CuSn
Thread	Plastic	Plastic
Max. short-circuit current I _k 0.05 s	4.5 kA	7.0 kA



Screw-in earthing insert with M10 connection

Conductive thread.

To be screwed into E27 and E33 threaded fuse holders using a TI earthing handle.

Type	ESE E27 KBI M10	ESE E33 KBI M10
Part No.	745 203	745 204
Size	E27	E33
Contact pin	Plastic	Plastic
Thread	Brass/gal CuSn	Brass/gal CuSn
Max. short-circuit current I _k 0.05 s	4.5 kA	7.0 kA



Earth clamp with flexible adjustable handle and two setting positions

To be connected to the earth cable end of earthing and short-circuiting devices for cable distribution cabinets, with M8 pin, anti-rotation element and nut.

Type	EK I FL20 DGF
Part No.	745 602
Clamping range	Up to 20 mm

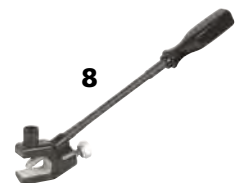

Bare earth clamp with wing bolt

To be connected to the earth cable end of earthing and short-circuiting devices for cable distribution cabinets, with M8 pin, anti-rotation element and nut.

Type	EK FL20 FS
Part No.	745 502
Clamping range	Up to 20 mm



Spring-loaded compact clamp

With threaded bolt M8 x 12 mm and hexagon locking screw (wrench size 10).

Fixed by means of adjustable handle with flexible shaft.

Type	KK M8 0 24 SK 10
Part No.	745 508
Clamping range	Up to 24 mm
Max. short-circuit current I _k 0.5 s	10.0 kA
Max. short-circuit current I _k 1 s	6.9 kA



4. Carry out Earthing and Short-Circuiting – EaS Devices

Accessories for Earthing and Short-Circuiting Devices (partly insulated) for Low-Voltage Cable Distribution Cabinets



9

TI Earthing handle

With dual function.

- For installing earthing cartridges or screw-in earthing inserts with M10 connection
- For connecting TI earthing and short-circuiting devices to earthing cartridges (wrench size 19)

Type	EG TI EKV
Part No.	745 400
Length	355 mm

**Rotary handle with flexible shaft**

With magnetic socket wrench insert.

For connecting spring-loaded earth clamps.

Type	DGF EKV VI
Part No.	745 921
Length	290 mm

Earthing and Short-Circuiting Devices for Crane Conductor Bars



Three-pole earthing and short-circuiting device with screw clamps.

**With screw clamps**

- For insulated or bare conductor bars of cranes and lifting equipment
- Allows to lock the clamping range of the clamps in several positions
- Waterproof, plastic-sheathed cable entries and node unit, with additional ant-kink protection
- Other cable lengths can be selected online via the earthing and short-circuiting configurator

General Information:	
Standard	EN/IEC 61230 (DIN VDE 0683-100)
Temperature range	-25 °C ... +55 °C
Material (clamp body)	MCl/gal Zn
Material (pressure plates)	Cu alloy
Material (short-circuiting cables)	Cu, highly flexible

4. Carry out Earthing and Short-Circuiting – EaS Devices

With Screw Clamps for insulated Conductor Bars

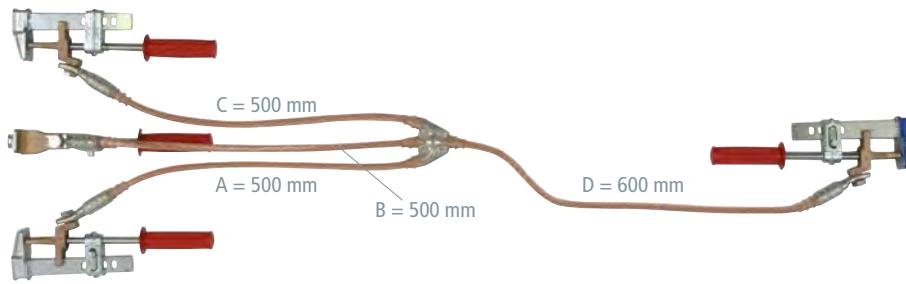

Type EKV3 ...	25IS ZK VH8QTCZ	35IS ZK VKB2Q6J	50IS ZK VP6YV4T
Variant No.	VH8QTCZ	VKB2Q6J	VP6YV4T
Clamping range	55 mm	55 mm	55 mm
Cable cross-section Cu	25/25 mm ²	35/35 mm ²	50/50 mm ²
Max. short-circuit current I_k 0.5 s	7.0 kA	10.0 kA	14.0 kA
Max. short-circuit current I_k 1 s	4.9 kA	6.9 kA	9.9 kA

Attention: Please state the relevant Variant No. when ordering.

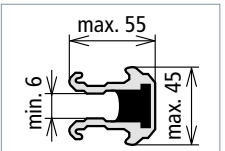

Insulated conductor bar

With Screw Clamps for bare Conductor Bars

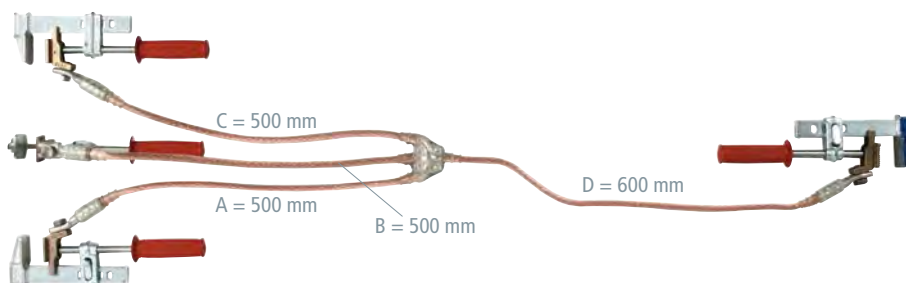

Type EKV3 ...	25BS ZK VQKTK4T	35BS ZK VN63A91
Variant No.	VQKTK4T	VN63A91
Clamping range	85 mm	85 mm
Cable cross-section Cu	25/25 mm ²	35/35 mm ²
Max. short-circuit current I_k 0.5 s	7.0 kA	10.0 kA
Max. short-circuit current I_k 1 s	4.9 kA	6.9 kA

Attention: Please state the relevant Variant No. when ordering.

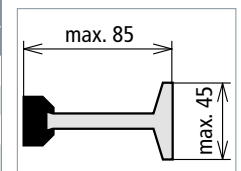

Bare conductor bar

The clamp for the PEN conductor is marked in blue.

Accessories for Earthing and Short-Circuiting Devices for Crane Conductor Bars

Screw clamps for insulated conductor bars

With M12 bolt.

Type	ZK55 IS	ZK55 IS BL
Part No.	771 230	771 231
Clamping range	55 mm	55 mm
Anti-rotation element	PK2	PK2
For cable cross-section Cu	25 ... 50 mm ²	25 ... 50 mm ²
Max. short-circuit current I_k 0.5 s	14.0 kA	14.0 kA
Max. short-circuit current I_k 1 s	9.9 kA	9.9 kA



Screw Clamps for bare conductor bars

With M12 bolt.

Type	ZK85 BS	ZK85 BS BL
Part No.	771 232	771 233
Clamping range	85 mm	85 mm
Anti-rotation element	PK2	PK2
For cable cross-section Cu	25 ... 35 mm ²	25 ... 35 mm ²
Max. short-circuit current I_k 0.5 s	10.0 kA	10.0 kA
Max. short-circuit current I_k 1 s	6.9 kA	6.9 kA



4. Carry out Earthing and Short-Circuiting – EaS Devices

Earthing and Short-Circuiting Device for Street Lighting Systems



- For junction and fuse boxes of street lighting systems
- For E14 fuse links
- E27 to E14 thread aluminium adapter
- Max. backup fuse 125 A power circuit breaker (B characteristic)

Earthing and short-circuiting device installed at a junction and fuse box of a street lighting mast

Kit in Plastic Case

Kit includes:			
Pos.	Part No.	Pos.	Part No.
1	1x 745 106	4	1x 745 109
2	2x 745 107	5	1x 745 921
3	6x 745 108		

For more detailed information on these products, see Single Parts.



Type	EKV ÜGK MB S
Part No.	745 105
Dimensions	395 x 295 x 105 mm

Single Parts and Accessories for Earthing and Short-Circuiting Device for Street Lighting Systems



Plastic case, empty

With foam padding.

1

Type	KKL EKV ÜGK MB
Part No.	745 106
Dimensions	395 x 280 x 110 mm
Colour	Grey

Earthing and short-circuiting device for street lighting systems

With three fixed E14 screw-in earthing inserts and spring-loaded earth clamp, clamping range up to 24 mm (fixed via rotary handle DGF EKV VI).

2

Type	EKV ÜGK MB
Variant No.	745 107
Cable cross-section	6 mm ²



D = 240 mm

A, B, C = 270 mm

4. Carry out Earthing and Short-Circuiting – EaS Devices

Single Parts and Accessories for Earthing and Short-Circuiting Device for Street Lighting Systems

Earthing and short-circuiting device for street lighting systems

With two permanently mounted E14 screw-in earthing inserts and two spring-loaded earth clamp, clamping range up to 24 mm (fixing via adjustable handle DGF EKV VI).

Type	EKV ÜGK MB SN7724
Variant No.	745 121
Cable cross-section (phase side)	6 mm ²



Earthing and short-circuiting device for street lighting systems

With three permanently mounted E14 screw-in earthing inserts and spring-loaded earth clamp, clamping range up to 24 mm (fixing via adjustable handle DGF EKV VI).

Type Süwag

Type	EKV ÜGK MB SN7354
Variant No.	745 115
Cable cross-section	6 mm ²
Type	with ratchet screw 4x10 mm



Compact clamp for street lighting

With M8 x 12 mm threaded screw and hexagon locking screw WS10. To be fixed by means of turning handle with flexible shaft.

Type	KKS M8 0 24 SK10
Part No.	745 509
Clamping range	up to 24 mm



E27 / E14 Adapter

Reducing insert for converting from E27 to E14 threads.

Allows to use earthing and short-circuiting devices with E14 screw-in earthing inserts even for E27 threads.

Type	RED E27 E14 ÜGK MB
Part No.	745 108
Dimensions	Ø30 x 25 mm
Material	Al



Installation adapter

For installing E27 / E14 adapters and gauge rings for D-fuses DII and DIII.

Type	PSS DII
Part No.	745 109
Dimensions	Ø30 x 110 mm
Material	Plastic



Rotary handle with flexible shaft

With magnetic socket wrench insert.

For connecting spring-loaded earth clamps.

Type	DGF EKV VI
Part No.	745 921
Length	290 mm



4. Carry out Earthing and Short-Circuiting – EaS Devices

Earthing Handle for Low-Voltage Installations



Attaching an earthing and short-circuiting device in a low-voltage switchgear installation using an earthing handle.

For low-voltage installations

- For attaching earthing and short-circuiting devices in low-voltage installations
- End fitting with plug-in coupling for extending the handle
- Light-weight construction
- Hexagon shaft (WS19) or T pin shaft

General Information:

Standard	T pin shaft DIN 48087
Temperature range	-25 °C ... +55 °C
Material (insulating tube)	Glass-fibre reinforced polyester tube
Material (coupling)	Plastic
Material (end fitting)	Plug-in coupling for extending the handle

Earthing Handle for Hexagon Shafts, Plug-in Coupling

Handle termination with plastic plug-in coupling for extending the handle (spring locking mechanism)

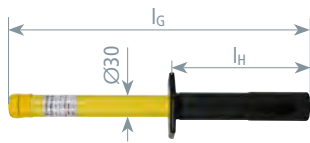

Type EG ...	SK STK 400
Part No.	745 415
Total length (l _G)	400 mm
Length (handle) (l _H)	185 mm

Earthing Handle for T Pin Shafts, Plug-in Coupling

Handle termination with plastic plug-in coupling for extending the handle (bayonet locking mechanism)

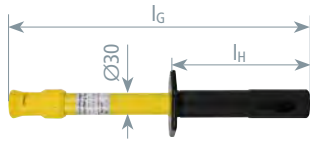

Type EG ...	SQ STK 400
Part No.	745 414
Total length (l _G)	400 mm
Length (handle) (l _H)	185 mm

Insulating Protective Shutters

Rated voltages from 1 kV to 36 kV

- Protection against accidental contact with live parts of installations with rated voltages from 1 kV to 36 kV
- Four different designs for use in almost all types of switchgear installations



General Information:

Standard	DIN VDE 0682-552
For	Use in indoor installations only



Inserting an insulating protective shutter (type A3) by means of an operating stick

According to the five safety rules, adjacent parts are parts situated in the vicinity zone. If parts of an installation near the work location cannot be disconnected, additional safety measures must be taken before starting work as is the case with work in the vicinity of live parts.

Insulating protective shutters according to DIN VDE 0682-522 are used to provide protection against accidental contact with live parts of an installation. They are portable and inserted under live conditions by hand or by using an operating stick.

Insulating protective shutters are designed for short-term use in indoor electrical installations according to DIN VDE 0101 with voltages from 1 to 36 kV a.c. at nominal frequencies below 100 Hz to provide protection against direct contact according to DIN VDE 0105-100 when working in the vicinity of live parts.

When used in medium-voltage installations, insulating protective shutters might have to be adapted, for example if it is not possible to insert shutters in the live working zone without risk due to unfavourably located drives, switch components or isolating plates. In such cases, a standard-compliant solution can be found by cutting out parts of the insulating protective shutter or cutting it to size. For that purpose, technical details must be provided. We have developed a special template for insulating protective shutters which can be used, for example, to mark the exact location of cut-outs.

For enquiries and orders, please fill in the template on our website www.dehn-international.com.

Note

Insulating protective shutters do not protect against re-connection. The protected area is the area which is separated from the area containing live parts by the insulating protective shutter. The minimum distances shown in the above table between shutters / shutter edges and live parts must be observed.

The protective part (with length l_s and, if required, height h_s) of insulating protective shutters is the part that provides protection against accidental contact with live parts. It is fitted with either a handle or a coupling for attaching an operating stick.

Outside the live working zone, the following gaps are permissible between shutter edge and cell wall:

- Up to 10 mm without restriction
- Up to 40 mm, if the distance between the shutter edge and the live working zone is at least 100 mm
- Up to 100 mm near a switch subconstruction

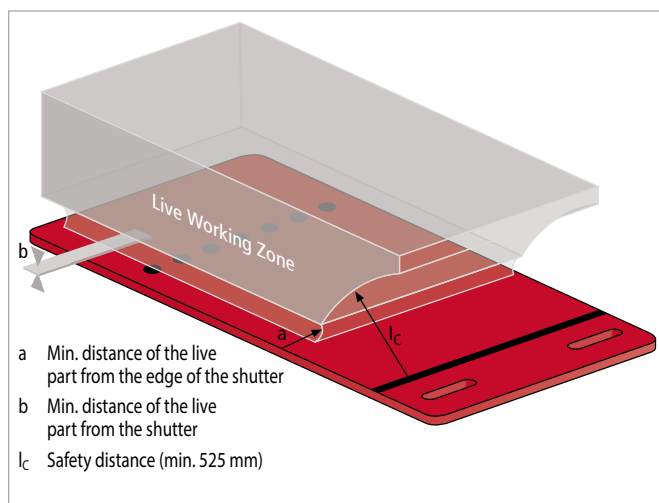

Example of a live working zone in case of an insulating protective shutter of type A1

Rated voltage	Minimum distance of the live part	
	from shutter edge a	from shutter b
3.6 kV	60 mm	0 mm
7.2 kV	90 mm	0 mm
12.0 kV	120 mm	20 mm
24.0 kV	220 mm	60 mm
36.0 kV	320 mm	100 mm

5. Provide Protection against adjacent Live Parts – Insulating Protective Shutters

Due to the various designs of switchgear installations, DIN VDE 0682-552 defines four different basic types of protective shutters:

A1, safety distance provides protection during inserting and removing insulating protective shutters

A2, protective section provides protection during inserting and removing insulating protective shutters

A3, operating stick provides protection during inserting and removing insulating protective shutters

A4, protective device installed in the installation provides protection during inserting and removing insulating protective shutters

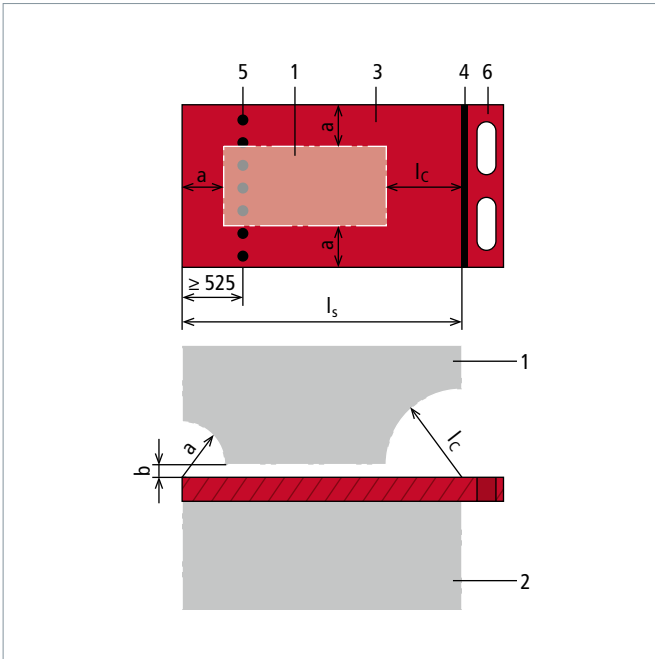

Protective shutter of type A1 – Operation by hand

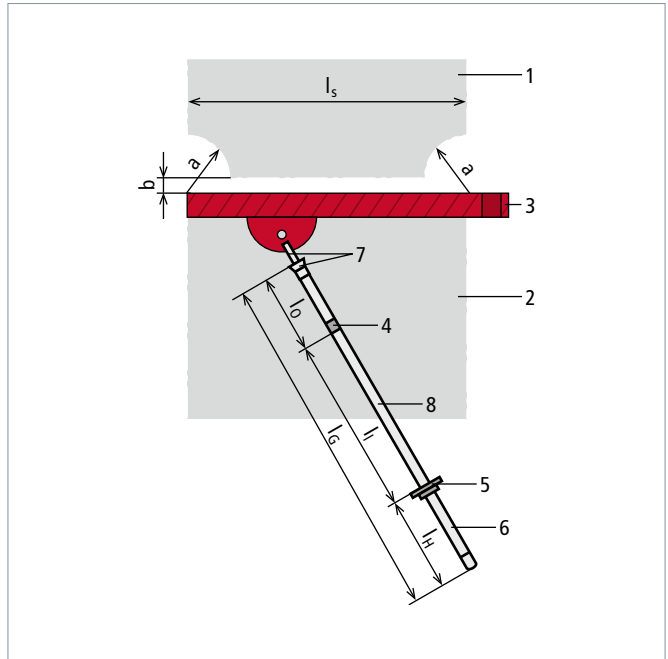

Protective shutter of type A3 – Operation by means of an operating stick

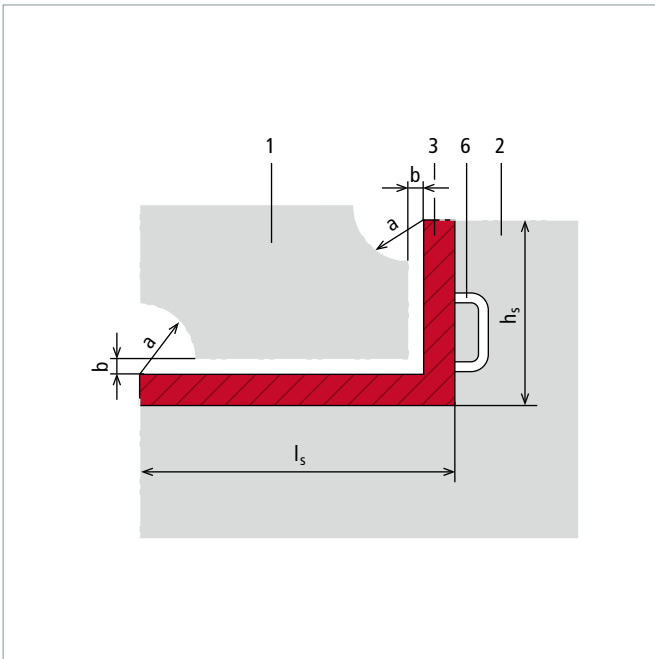

Protective shutter of type A2 – Operation by hand

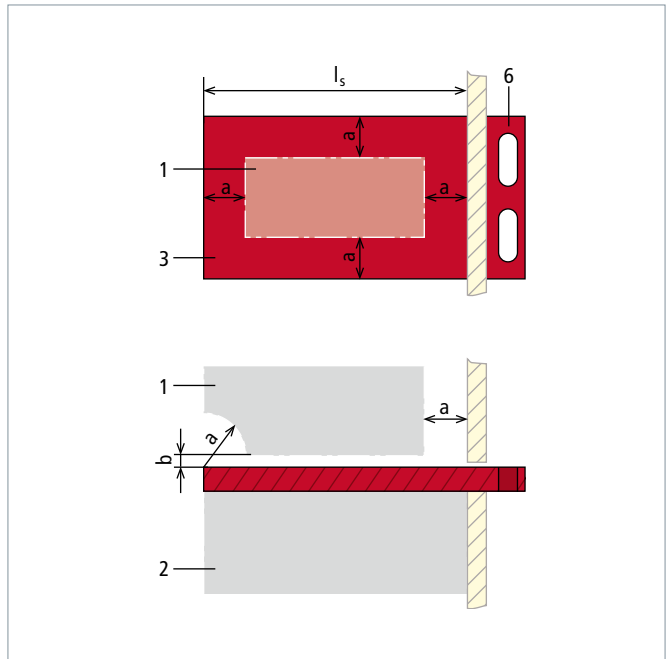

Protective shutter of type A4 – Operation by hand

- 1 Live working zone
- 2 Protected area
- 3 Protective section with length l_s (and height h_s)
- 4 Limit mark or red ring
- 5 Guide mark / hand guard
- 6 Handle
- 7 Coupling
- 8 Insulating element of the operating stick with length l_i

- l_G Total length of the operating stick
- l_0 Length of the top section of the operating stick
- l_H Length of the handle of the operating stick
- l_I Length of the insulating element of the operating stick
- l_s Length of the protective section
- l_c Safety distance
- a Minimum distance of live parts from the edge of the insulating protective shutter
- b Minimum distance of live parts from the insulating protective shutter

Type A1

With finger holes, guide and limit mark for inserting and removing insulating protective shutters into / from guide rails by hand.

The guide mark is a dotted line with a minimum distance of 525 mm from the rear shutter edge. The section beyond this mark must not be contacted when inserting the insulating protective shutter.

The limit mark is a continuous line and separates the handle from the protective section. The section beyond this mark must not be contacted when inserting the insulating protective shutter and must be at least 525 mm away from live parts when the shutter has been inserted.

Type ISP 36 PVC ...	A1...
Part No.	763 211
Rated voltage (U _r)	Up to 36 kV
Material	Rigid PVC



Type A2

With 90° angled handle and hand grips for inserting or removing insulating protective shutters into / from guide rails by hand. Other angled handles (70° to 270°) are available on request.

The height of the handle has to be selected in such a way that live parts of the installation above the shutter are completely covered.

Type ISP 36 PVC ...	A2...
Part No.	763 221
Rated voltage (U _r)	Up to 36 kV
Material	Rigid PVC



Type A3

With retaining device with bayonet pin for inserting and removing insulating protective shutters into / from guide rails using an operating stick.

This shutter type is also available with a longitudinal slot and a retaining device (rotatable shutter). In this case, the shutter is operated using an operating stick with switching stick head. Two persons are required to insert / remove shutter sizes exceeding 1 m². For this purpose, two retaining devices for attaching operating sticks are required. Moreover, insulating protective shutters are also available with rolls.

Type ISP 36 PVC ...	A3...
Part No.	763 231
Rated voltage (U _r)	Up to 36 kV
Material	Rigid PVC



Type A4

With finger holes (without additional marks) for use in factory assembled switchgear panels. Instead of finger holes, the shutters are also available with a grip (minimum height: 35 mm).

The shutter is inserted through a slot into the closed installation.

The protective device of the installation must ensure full protection when inserting and removing the shutter. In type-tested switchgear installations in accordance with DIN VDE 0670-6 and 7 or EN/IEC 62271-200 (DIN VDE 0671-200), insulating protective shutters may only be used in consultation with the manufacturer of the switchgear installation.

Type ISP 36 PVC ...	A4...
Part No.	763 241
Rated voltage (U _r)	Up to 36 kV
Material	Rigid PVC



Guide rails and other accessories are listed in our template (DEHN Form No. 2090/E).



DEHN protects.®

Live Working

Cleaning Equipment / Protective and Auxiliary Equipment

Product	Type	Nominal voltage U_N / Frequency f_N	Application, Indication	Page
TRS NS Dry Cleaning Kit				
	TRS NS	up to 1000 V / 15 ... 60 Hz	Live cleaning by suction Specially adapted operating heads for intensive cleaning Plug-in coupling system allows fast replacement of operating heads	117
TRS MS Dry Cleaning Kit				
	TRS MS TRS MS V1	up to 15 kV / 15 ... 60 Hz	Live cleaning by suction Transparent intake tubes for enhanced safety Specially adapted operating heads for intensive cleaning Plug-in coupling system allows fast replacement of operating heads	118
FRS ZK MS Damp Cleaning Kit				
	FRS ZK MS	up to 36 kV / 15 ... 60 Hz	Damp cleaning equipment for use under live conditions with special cleaning liquid Universal gear coupling for replacing and adjusting the angle of operating heads Plug-in operating heads allow fast and easy replacement of sponges	119
TFRS MS Combined Cleaning Kit				
	TFRS MS	up to 36 kV / 15 ... 60 Hz	Combined equipment for dry and damp cleaning Transparent intake tubes for enhanced safety Specially adapted operating heads for intensive cleaning Universal gear coupling for replacing and adjusting the angle of operating heads Plug-in operating heads allow fast and easy replacement of sponges	120
PPE – Personal Protective Equipment				
		up to 1000 V	NH fuse puller with sleeve Insulating gloves	123
Covering Material and Insulating Mats				
		up to 1000 V up to 50 kV	Covering material and wrapping tape Insulating mats for insulating the operating location	124 125
Maintenance Tests according to German regulations DGUV Vorschrift 3 (former BGV A3)				
			Operating sticks must be subjected to electrotechnical tests. Therefore, we recommend to test them with the prescribed limits as stated in the Electrical Safety Rules according to German regulations DGUV Vorschrift 3 (former BGV A3). This test includes: – measurement of the leakage current – test for protection against bridging, – visual inspection This maintenance test is documented in a test report and on the device. The test intervals depend on the operating conditions of the operating stick e.g. frequency of use, environmental conditions and transport. According to German regulations, however, it is advisable to carry out a maintenance test at least every 6 years .	145

Cleaning Equipment

Live Working

Permanent availability of electricity has become a decisive factor in international competition. At the same time, power interruptions must be reduced as a result of the increasing cost pressure. This makes it difficult to ensure reliability of existing installations and to perform maintenance work as entire parts of the installation cannot be disconnected and the only alternative is live working. DEHN has long-standing experience in the field of live working and has developed products which can be found in the DELTEC product range.

Disconnecting installations for maintenance work

Electrical equipment and low-voltage, medium-voltage and high-voltage systems such as overhead lines, transformer substations, switchgear installations, distribution boards, transformer cells or cable distribution cabinets cannot be disconnected or can only be disconnected with great effort due to undesired downtimes or costly work on Sundays and public holidays.

Live cleaning

Clean installations increase system reliability

In case of adverse weather conditions (moisture), arcs may occur as a result of soiled installations, dust layers and residues from lubricants on insulators and cable sealing ends in medium-voltage installations, cobwebs and weeds in cable distribution boards as well as dust and lubricant layers in low-voltage installations, resulting in power failure, damage to the equipment and even injury or death.

Regular cleaning intervals

Surveys revealed that open indoor installations and cable distribution cabinets have to be cleaned at regular intervals between 6 months and 2 years depending on the type and degree of pollution.

Dry suction cleaning combined with damp cleaning

Dry cleaning work is performed by suction cleaning with operating heads or brushing soiled parts of the installation while simultaneously sucking the dirt away. Loose layers of dust and cobwebs are easily cleaned with little effort. Damp cleaning eliminates oily and tough pollutant layers with the help of sponges soaked with special insulating cleaning liquid. This type of work is performed according to the "hot stick working" procedure.

Dry suction cleaning equipment

Suction cleaning equipment consists of a cleaning head (operating heads, brushes), intake tube with handle, extension, intake hose and suction device.

All single parts are made of plastic and are fully insulated. The shape of the brushes and operating heads is largely adapted to the parts of installations to be cleaned.

The special plug-in coupling system of the dry cleaning equipment prevents accidental use of accessories not intended for this application (e.g. accessories of industrial vacuum cleaners).

Requirements on the vacuum cleaner

The vacuum cleaner used must meet the following requirements:

- The industrial vacuum cleaner must have a minimum air velocity of 20 m/s and a visual indication of the intake capacity.
- The intake hose must have a continuous inner diameter ≥ 30 mm and must not contain any metal parts.

Damp cleaning equipment

Damp cleaning equipment consists of special cleaning heads (sponge holders), an insulating stick with handle and extension elements. All single parts are fully insulated. The plug-in system of operating heads and sponges allows easy and fast replacement of dirty sponges. Only approved sponges may be used for this purpose.

Requirements on installers

Selection of electrically skilled persons for live working

Only electrically skilled persons with experience of several years in the operation and maintenance of electrical installations are allowed to perform maintenance and repair work. Electrically skilled persons must be theoretically and practically trained for this type of work.

Training as live worker

The training as specialised live worker is based on detailed target descriptions as required by the German trade association BG ETEM "Live working on electrical installations and equipment", DGUV regulation 103-011 (previously BGR A3). It includes theoretical and practical training and a "live working" certificate upon completion of the training.

"Live working" procedure

During hot stick working, the worker keeps a predefined distance from live parts of the installation and uses insulating sticks/operating sticks.

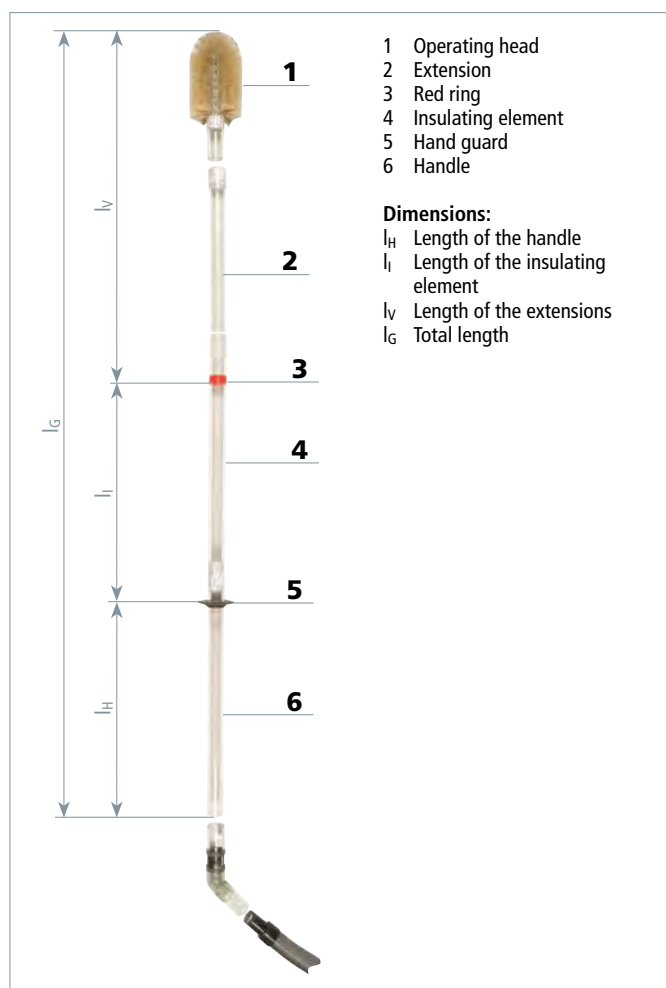

Design

Cleaning Equipment

TRS NS Dry Cleaning Kit

Nominal voltages up to 1000 V / 15 ... 60 Hz

- For indoor and outdoor installations
- Equipment for suction cleaning under live conditions
- For dry cleaning of cable distribution cabinets, open indoor installations and control cabinets
- Specially adapted operating heads for intensive cleaning
- Plug-in coupling system allows fast replacement of operating heads
- Regulation of intake air in the handle area



Live cleaning of a low-voltage switchgear installation using the TRS NS dry cleaning kit.

General Information:

Standard	Based on DIN VDE 0682-621
Not for use in wet weather conditions	



Requirements

Cleaning work up to 1000 V generally is allowed to be done under supervision of a qualified electrician according to EN 50110-1 "Operation of electrical installations" and is allowed to be done in accordance with the national accident prevention regulations (UVV) "Elektrische Anlagen und

Betriebsmittel" [Electrical installations and equipment] stipulated by the German Employer's Liability Association for the energy, textile, electrical and media product sector (BG ETEM) under observation of DGUV regulation 3 (previously BGV A3).

TRS NS Dry Cleaning Kit

Fully equipped plastic case.

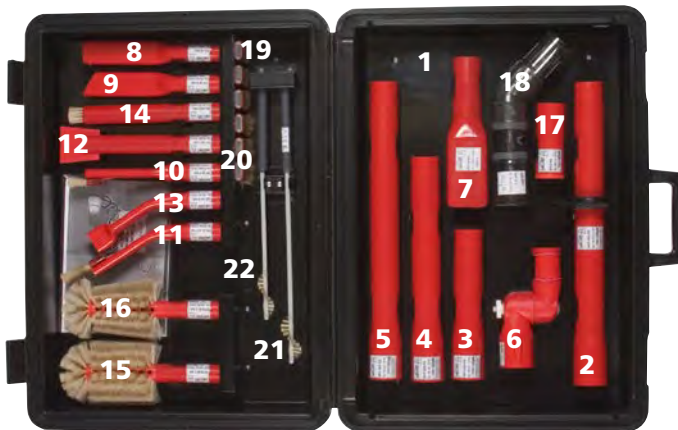

Kit includes:

Pos.	Part No.	Pos.	Part No.
1	785 506	12	785 560
2	785 520	13	785 543
3	785 521	14	785 570
4	785 522	15	785 550
5	785 523	16	785 555
6	785 530	17	785 515
7	785 540	18	785 200
8	785 541	19	785 595
9	785 542	20	785 596
10	785 590	21	785 580
11	785 591	22	785 585

For more detailed information on these products, see www.dehn-international.com.

Type	TRS NS
Part No.	785 502
Dimensions	560 x 410 x 170 mm
Total length (l _{G max} / l _{G min})	1350 / 560 mm



Cleaning Equipment

TRS MS Dry Cleaning Kit



Live cleaning of a transformer using the TRS MS dry cleaning kit.

Nominal voltages up to 36 kV / 15 ... 60 Hz

- For indoor and outdoor installations
- Equipment for live cleaning by means of suction
- For dry cleaning of transformers and switchgear installations
- Transparent intake tubes ensure enhanced safety
- Specially adapted operating heads for intensive cleaning
- Plug-in coupling system allows fast replacement of operating heads

General Information:

Standard	DIN VDE 0682-621
Not for use in wet weather conditions	



Requirements

Cleaning work from 1 to 36 kV must be carried out under supervision of a qualified electrician according to EN 50110-1 "Operation of electrical installations – Minimum Requirements", observing clauses 6.3.1 to 6.3.12. In Germany TRS MS dry cleaning kits are subject to DGUV Vorschrift 3 (previously BGV A3) and DGUV Regel 103-011 (previously BGR A3) of the national accident prevention regulations (UVV) "Elektrische Anlagen und Betriebsmittel" [Electrical installations and equipment] stipulated by the German Employer's Liability Association for the Energy, Textiles, Electric and Media Industry (BG ETEM).

TRS MS / TRS MS V1 Dry Cleaning Kit

Fully equipped GRP case.



TRS MS Kit includes:

Pos.	Part No.	Pos.	Part No.
1	785 301	19	785 140
5	785 131	20	785 150
6	785 132	21	785 170
7	785 130	25	785 220
10	785 120	26	785 221
15	2x 785 121	39	785 200
16	2x 785 122	42	785 180
17	2x 785 123	44	785 190
18	785 160	47	785 210

For more detailed information on these products, see www.dehn-international.com.

TRS MS V1 Kit includes:

Pos.	Part No.	Pos.	Part No.
1	785 301	21	785 170
5	785 131	22	785 171
6	785 132	23	785 172
7	785 130	25	785 220
10	785 120	26	785 221
15	2x 785 121	39	785 200
16	2x 785 122	40	785 212
17	785 123	42	785 180
18	785 160	44	785 190
19	785 140	47	785 210

For more detailed information on these products, see www.dehn-international.com.

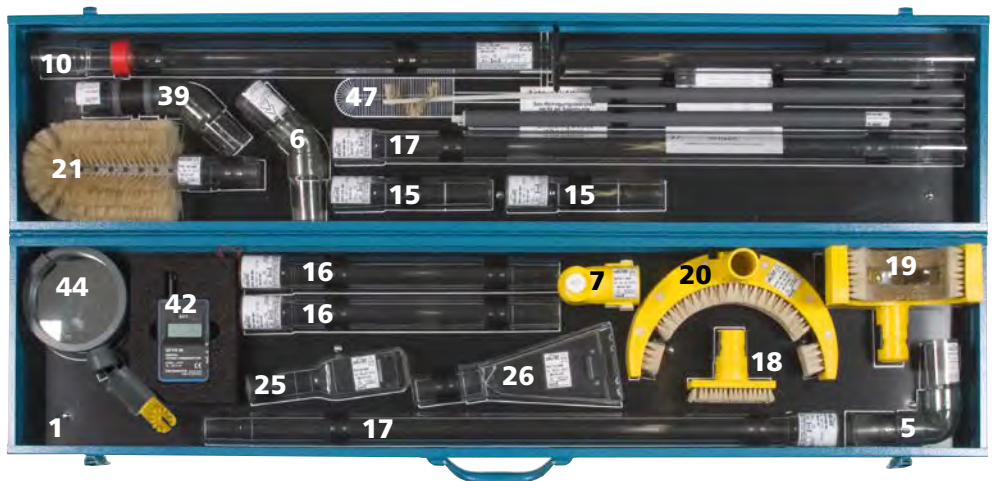

Type TRS ...	MS	MS V1
Part No.	785 100	785 112
Dimensions	1260 x 305 x 205 mm	1260 x 305 x 205 mm
Total length (lG max / lG min)	3580 / 1180 mm	3580 / 1180 mm
Extension (lG max / lG min)	2515 / 115 mm	2515 / 115 mm

Note: The Pos. Nos. highlighted in grey indicate the differences between the dry cleaning kits.

Cleaning Equipment

FRS ZK MS Damp Cleaning Kit

Nominal voltages up to 36 kV / 15 ... 60 Hz

- For indoor and outdoor installations
- Damp cleaning equipment for use under live conditions with special cleaning liquid
- Universal gear coupling for replacing and adjusting the angle of operating heads
- Rigid and flexible plug-in operating heads allow fast and easy replacement of the sponges

General Information:

Standard	Based on DIN VDE 0681-1 and DIN VDE 0682-621
Standard (universal gear coupling)	EN/IEC 60832 (DIN VDE 0682-211)
Not for use in wet weather conditions	

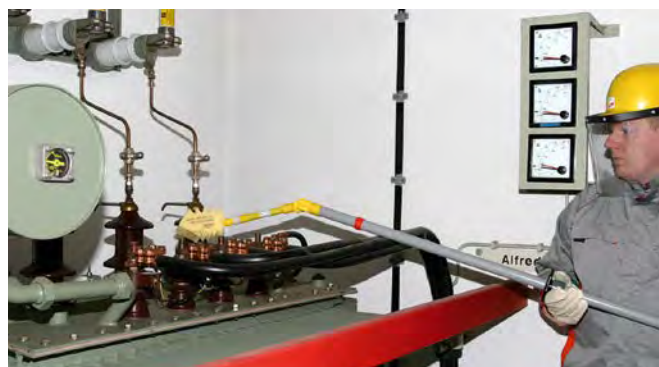

Damp cleaning of a transformer using the FRS ZK MS damp cleaning kit.



Application

Damp sponges allow to remove tough pollution layers and to clean oily transformer surfaces. Special insulating cleaning liquids (e.g. Rivolta SLX 500; SLX TOP or SLX Super from Bremer & Leguil, Duisburg/Germany, and Florin 2000 from Flore, Koblenz/Germany) must be selected according to the rated voltage of the installation and the environmental conditions.

Requirements

Cleaning work from 1 to 36 kV must be carried out under supervision of a qualified electrician according to EN 50110-1 "Operation of electrical installations – Minimum Requirements", observing clauses 6.3.1 to 6.3.12. In Germany FRS ZK MS damp cleaning kits are subject to DGUV Vorschrift 3 (former BGV A3) and DGUV Regel 103-011 (former BGR A3) of the national accident prevention regulations (UVV) "Elektrische Anlagen und Betriebsmittel" [Electrical installations and equipment] stipulated by the German Employer's Liability Association for the energy, textile, electrical and media product sector (BG ETEM).

FRS ZK MS Damp Cleaning Kit

Fully equipped GRP case.



Kit includes:			
Pos.	Part No.	Pos.	Part No.
2	785 229	32	785 324
8	785 315	33	785 322
11	785 316	34	785 323
12	785 317	35	785 274
13	785 318	36	785 275
14	785 319	37	785 279
30	785 320	38	785 280
31	785 321		

For more detailed information on these products, see www.dehn-international.com.

Type	FRS ZK MS
Part No.	785 940
Dimensions	945 x 285 x 170 mm
Total length (l _{G max} / l _{G min})	3250 / 1450 mm
Extension (l _{G max} / l _{G min})	2100 / 350 mm

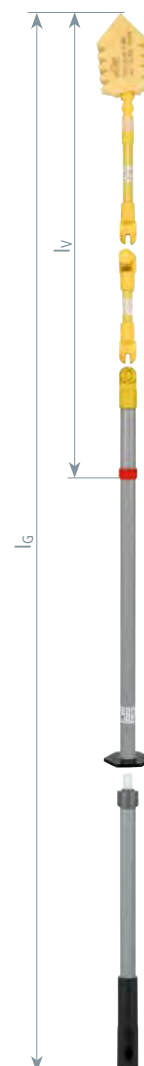

Cleaning Equipment

TFRS MS Combined Cleaning Kit

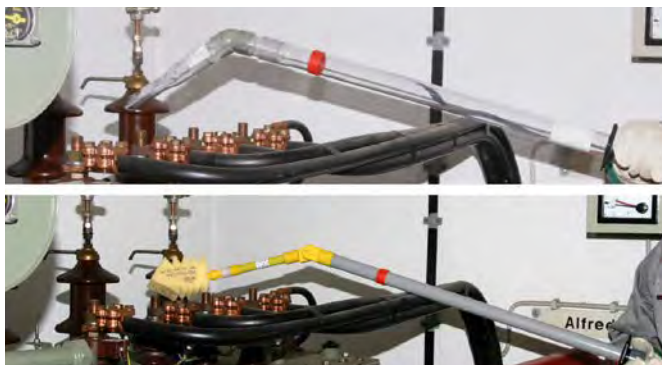

TFRS MS combined cleaning kit used for dry and damp cleaning of a transformer under live conditions.



Nominal voltages up to 36 kV / 15 ... 60 Hz

- For indoor and outdoor installations
- Combined dry and damp cleaning kit for cleaning under live conditions
- Transparent intake tubes ensure enhanced safety
- Specially adapted operating heads for intensive cleaning
- Universal gear coupling for replacing and adjusting the angle of operating heads
- Rigid and flexible plug-in operating heads allow fast and easy replacement of the sponges

General Information:

Standard	Based on DIN VDE 0681-1 and DIN VDE 0682-621
Standard (universal gear coupling)	EN/IEC 60832 (DIN VDE 0682-211)
Not for use in wet weather conditions	

Application

Dry cleaning work is performed by suction cleaning with operating heads or brushing soiled parts of the installation while simultaneously sucking the dirt away. Loose dust layers and cobwebs are easily removed with little effort. Damp cleaning eliminates oily and tough contaminants with the help of sponges soaked with special insulating cleaning liquids.

TFRS MS Combined Cleaning Kit

Fully equipped GRP case and leather bag.



Requirements

Cleaning work from 1 to 36 kV must be carried out under supervision of a qualified electrician according to EN 50110-1 "Operation of electrical installations – Minimum Requirements", observing clauses 6.3.1 to 6.3.12. In Germany TFRS MS combined cleaning kit are subject to DGUV Vorschrift 3 and DGUV Regel 103-011 (previously BGV A3 and BGR A3) of the national accident prevention regulations (UVV) "Elektrische Anlagen und Betriebsmittel" [Electrical installations and equipment] stipulated by the German Employer's Liability Association for the Energy, Textiles, Electric and Media Industry (BG ETEM).

Kit includes – Case:

Pos.	Part No.	Pos.	Part No.
3	785 951	27	785 223
5	785 131	28	785 551
6	785 132	29	785 552
7	785 130	30	785 320
11	785 316	31	785 321
12	785 317	32	785 324
13	785 318	33	785 322
14	2x 785 319	34	785 323
15	785 121	35	785 274
16	785 122	36	785 275
17	2x 785 123	37	785 279
18	785 160	38	785 280
19	785 140	39	785 200
20	785 150	40	785 212
21	785 170	41	785 259
22	785 171	43	785 181
23	785 172	44	785 190
24	785 151	45	785 953
25	785 220	46	785 224
26	785 221		

Kit includes – Bag:

Pos.	Part No.	Pos.	Part No.
4	785 952	47	785 210
9	785 325	48	785 585
10	785 120	49	785 109

For more detailed information on these products, see www.dehn-international.com.



Type	TFRS MS
Part No.	785 950
Dimensions (bag)	1400 x 280 mm
Dimensions (case)	900 x 415 x 430 mm

Cleaning Equipment

Accessory for NS and MS Cleaning Kits

Industrial vacuum cleaner

For dry and combined cleaning kits.

Equipment:

25 l special plastic container, 2 large wheels, 2 guide wheels with locking brakes, handle and cable holder, socket outlet with automatic switch-on mechanism, electromagnetic pulse filter cleaning, automatic vibration function, speed control, volume flow control, acceleration rate controller, electronic running feature, moisture identification with sensor-controlled disconnection, 2 new polyester filter cassettes, FKP 4300, filter area $2 \times 4300 \text{ cm}^2 = 8600 \text{ cm}^2$, dust collection capacity 99,99 %, class L in accordance with DIN EN 60335-2-69 Annex AA, cord length 8 m.

Technical data:

- Intake hose with straight connecting adapter $\varnothing 35 \text{ mm}$, 5 m long

Type	HISC 1600
Part No.	785 310
Dimensions	450 x 390 x 490 mm



Reducing inserts

For connection between SSA W D intake hose adapter and intake hoses from other manufacturers with different diameters and straight connecting adapter.

General Information:

Total length	105 mm
--------------	--------

Application:

intake hose with straight connecting adapter

SSA W D intake hose adapter
← Part No. 785 200

RSI ... reducing insert

Type	RSI 32	RSI 34	RSI 35	RSI 38
Part No.	785 213	785 214	785 215	785 216
Diameter	35 / 32 mm	35 / 34 mm	35 / 35 mm	35 / 38 mm

Type	RSI 45	RSI 51	RSI 58
Part No.	785 217	785 218	785 219
Diameter	35 / 45 mm	35 / 51 mm	35 / 58 mm



Tubular brush 80 mm

Cylindrical bristles.

Type	STB 80 ZK MS
Part No.	785 159
Total length	250 mm
Diameter	80 mm



Rectangular brush

Type	REB 25055 ZK MS
Part No.	785 169
Dimensions	250 x 55 x 155



Scraper

Type	S 100 ZK MS
Part No.	785 329
Total length	310 mm
Diameter	100 mm



Cleaning head 55 with scraper

For TRS MS and TFRS MS. Including 3 spare scrapers.

Type	FD 60 MS SN7271
Part No.	785 225
Total length	190 mm
Diameter	40 mm



90° Angled flat cleaning head with detachable brush

For TRS NS dry cleaning kits.

Type	FWD 35 P NS
Part No.	785 592
Total length	200 mm
Diameter	25 mm



Cleaning Equipment



Intake tube with handle

For TRS MS and TFRS MS cleaning kits.

Type	SRH 1180 IS 650 MS
Part No.	785 119
Total length	1180 mm, insulating element 650 mm
Diameter	40 mm



Canvas bag, empty

With two separate internal pockets and carrier handle.

Type	STT 55 27 30
Part No.	785 111
Dimensions	550 x 270 x 300 mm
Colour	Olive ●

Protective and Auxiliary Equipment

PPE – Personal Protective Equipment

Nominal voltages up to 1000 V

- For working on live parts
- Insulating gloves combine excellent fit and high elasticity with maximum insulation strength
- Two different models to suit your needs

General Information:

Standard (gloves)	EN 60903 (DIN VDE 0682-311)
Standard (NH fuse handle)	DIN VDE 0680-4; GS-ET-29 by the trade association

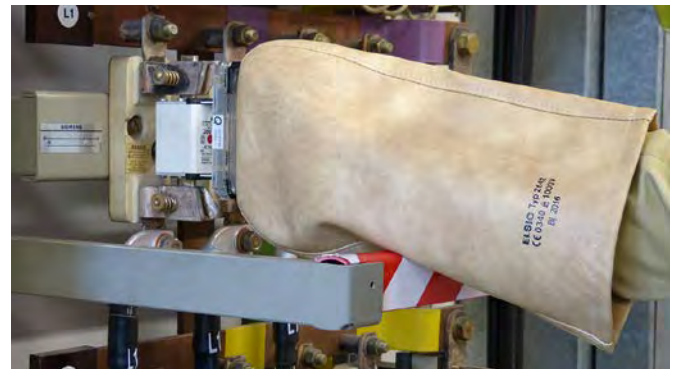

Operating an NH fuse with an NH fuse handle with sleeve.

NH Fuse Handle with Sleeve

- For actuating NH fuses of sizes 00, 1, 2 and 3

Type	NHS AG 00 3 NS
Part No.	785 645
Nominal voltage up to (U _N)	1000 V
Colour	Beige ●
Material	Coated cotton fabric



Insulating Gloves, Category M

- For high mechanical stress

Type	IHS 00 M 9 NS	IHS 00 M 10 NS	IHS 0 M 9 NS	IHS 0 M 10 NS
Part No.	785 491	785 492	785 493	785 494
Class	00	00	0	0
Nominal voltage up to (U _N)	500 V	500 V	1000 V	1000 V
Colour	Beige ●	Beige ●	Beige ●	Beige ●
Thickness	0.5 mm	0.5 mm	1.0 mm	1.0 mm
Size	9	10	9	10
Material	Latex	Latex	Latex	Latex



Insulating Gloves, Category RC

Resistant to acid, oil, ozone, high mechanical stress and extremely low temperatures. With inner coating and textured gripping surface.

Type	IHS 00 RC 9 NS	IHS 00 RC 10 NS
Part No.	785 495	785 496
Class	00	00
Nominal voltage up to (U _N)	500 V	500 V
Colour	Orange ●	Orange ●
Thickness	0.9 mm	0.9 mm
Size	9	10
Material	two-tone natural latex	two-tone natural latex



Accessories for PPE – Personal Protective Equipment

Storage bag, empty

With hook-and-loop fastener and hook.

Type	AT IHS NS
Part No.	785 490
Dimensions	400 x 180 x 50 mm
Colour	Brown ●



Pneumatic glove tester

For performing tests required by the standard.

Type	PHSP NS
Part No.	785 497
Colour	Grey ●



Protective and Auxiliary Equipment

Insulating Blankets and Matting



- Protection against accidental and direct contact with live parts
- For covering adjacent live parts
- Available in different lengths, widths, thicknesses and colours
- Insulating rubber mats for insulating the operating location

General Information:

Standard	Insulating blankets: EN/IEC 61112 (DIN VDE 0682-511); Insulating matting: EN/IEC 61111 (DIN VDE 0682-512)
----------	--

Covering live parts.

Insulating Blankets (Plastic)



Type	ATK 135 50M NS	ATK 135 ..M NS	ATK 120 25M NS	ATK 120 ..M NS
Part No.	785 465	785 466	785 467	785 468
Class	0	0	0	0
Nominal voltage up to (U _N)	1000 V	1000 V	1000 V	1000 V
Length	50 m	Any up to 50 m *)	25 m	Any up to 25 m *)
Width	1350 mm	1350 mm	1200 mm	1200 mm
Thickness	0.5 mm	0.5 mm	1.0 mm	1.0 mm
Colour	Crystal clear	Crystal clear	Transparent	Transparent

*) Required length to be specified at order!

Insulating Blanket (EPDM Elastomer)

With VDE / GS label, flexible at low temperatures.



Type	ATN 140 10M NS	ATN 140 ..M NS
Part No.	785 471	785 472
Class	0	0
Nominal voltage up to (U _N)	1000 V	1000 V
Length	10 m	Any up to 10 m *)
Width	1400 mm	1400 mm
Thickness	1.0 mm	1.0 mm
Colour	Red ●	Red ●

*) Required length to be specified at order!

Wrapping Tape (EPDM Elastomer)

For covering insulators



Type	WBN 200 2,5M NS
Part No.	785 646
Class	0
Nominal voltage up to (U _N)	1000 V
Length	2.5 m
Width	200 mm
Thickness	1.0 mm
Colour	Red ●

Insulating Rubber Mats for Insulating the Standing Surface



Type	IMG SI 1M NS	IMG SI 10M NS	IMG SI ..M NS
Part No.	785 455	785 457	785 456
Class	0	0	0
Nominal voltage up to (U _N)	1000 V	1000 V	1000 V
Length	1 m	10 m	Any up to 10 m *)
Width	1000 mm	1000 mm	1000 mm
Thickness	3.0 mm	3.0 mm	3.0 mm
Colour	Grey ●	Grey ●	Grey ●

*) Required length to be specified on order!

Protective and Auxiliary Equipment

Accessories for Insulating Blankets and Matting

Clip

With insulated steel spring.

Type	KK 35 NS
Part No.	785 647
Max. clamping range	35 mm
Dimensions	170 / 110 mm
Material	Plastic



Hook

Type	HK 8 NS
Part No.	785 648
Dimensions	Ø8, 126 / 72 mm
Material	Plastic



Eye

Two-piece

Type	OEK 12 NS
Part No.	785 649
Dimensions	Ø12 / 26 mm
Material	Plastic



Insulating Mats with Dielectric Strength 50 kV

- For use in electrical switch and test rooms
- Dielectric strength of 50 kV tested in accordance with DIN VDE 0303-21



Switch room floor covered with insulating mat 50 kV.

Type IMG SAN 1M ...	10M	..M
Part No.	785 459	785 458
Nominal voltage up to (U _N)	50 kV	50 kV
Length	10 m	up to 10 m *)
Width	1000 mm	1000 mm
Thickness	4.5 mm	4.5 mm
Colour	Grey ●	Grey ●

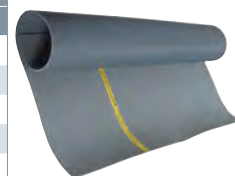











*) Required length to be specified at order!



DEHN protects.®

Arc Fault Protection

Passive Arc Fault Protection / Active Arc Fault Protection

Product	Application	Page
Passive Arc Fault Protection – DEHNcare® APC, APJ and APT		
	<p>Arc-fault-tested protective clothing</p> <ul style="list-style-type: none"> – Protective Coat – Protective Jacket – Protective Trousers <p>*) Protection against the thermal risks of an arc fault when working on electrical systems</p>	128
Passive Arc Fault Protection – DEHNcare® APG		
	<p>Arc-fault-tested protective gloves</p> <ul style="list-style-type: none"> *) Protection against the thermal risks of an arc fault when working on electrical systems  Protection against thermal risks  Protection against mechanical risks 	130
Passive Arc Fault Protection – DEHNcare® APHO		
	<p>Arc-fault-tested protective hood</p> <p>All-round protection for face, head and neck with 3-zone protective system</p> <p>*) Protection against the thermal risks of an arc fault when working on electrical systems</p>	131
Passive Arc Fault Protection – DEHNcare® ESH U S		
	<p>Insulating safety helmet for electricians (EN 50365)</p> <p>Six-point suspension with sweatband</p>	132
Passive Arc Fault Protection – DEHNcare® APS		
	<p>Arc-fault-tested face shield, suitable for all standard safety helmets for electricians</p>	133
Active Arc Fault Protection – Arc Fault Protection System		
	<p>Fixed Arc Fault Protection System DEHNshort</p>	135

*) Copyright © 2016 IEC Geneva, Switzerland. www.iec.ch

Passive Arc Fault Protection – DEHNcare®

DEHNcare® APJ, APT and APC



Attaching an earthing and short-circuiting device using adequate personal protective equipment.

APC/APJ



IEC 61482-1-2:2007
class 2
IEC 61482-1-1:2007
ATPV 33.1 cal/cm²

APT



IEC 61482-1-2:2007
class 2
IEC 61482-1-1:2007
ATPV 29.2 cal/cm²

Protective jackets, protective trousers and protective coats
Prevent injuries – Stay healthy

- Breathable leather ensures high wearing comfort
- Flame-retardant zip and hook-and-loop fasteners
- Reflective strips
- Certified in compliance with the 89/686/EEC directive on personal protective equipment

General Information:

Standard	Box test in accordance with IEC 61482-1-2; EN ISO 14116
Outer material	Siliconised calf grain leather, 100% Kevlar® interlock knit
Inner material	100% cotton
Material (sewing thread)	100% Kevlar®

Measure correctly

A Body height

Stand without shoes, e.g. at a wall and measure from tip to toe.

B Chest circumference

Measure horizontally at the largest width of chest.

C Waist circumference

Measure horizontally around the waist.

D Hip circumference

Measure horizontally at the largest width of back.

E Inner leg length

Measure along the leg from crotch to the ground.

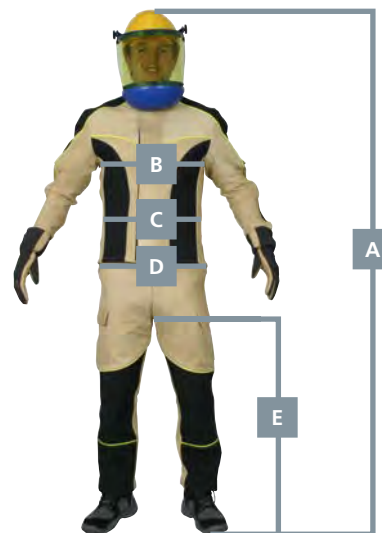

Part No.	Size	A Body height	B Chest circumference	C Waist circumference	D Hip circumference	E Inner leg length
Arc-fault-tested Protective Jacket and Trousers						
785 769 / 785 779	46 / S	169-174 cm	92-95 cm	79-82 cm	92-95 cm	77.5-80 cm
785 770 / 785 780	48 / M	172-177 cm	96-100 cm	83-86 cm	96-99 cm	79-81.5 cm
785 771 / 785 781	50 / M	175-180 cm	101-103 cm	87-90 cm	100-103 cm	80.5-83 cm
785 772 / 785 782	52 / L	178-183 cm	104-107 cm	91-94 cm	104-107 cm	82-84.5 cm
785 773 / 785 783	54 / XL	180-185 cm	108-111 cm	95-98 cm	108-111 cm	83-85.5 cm
785 774 / 785 784	56 / XXL	182-187 cm	112-115 cm	99-102 cm	112-115 cm	84-86.5 cm
785 775 / 785 785	58 / 3XL	184-189 cm	116-119 cm	103-107 cm	116-119 cm	85-87.5 cm
Arc-fault-tested Protective Coat						
785 755	48 / 50	172-180 cm	96-103 cm	83-90 cm	—	—
785 756	52 / 54	178-185 cm	104-111 cm	91-98 cm	—	—
785 757	56 / 58	182-189 cm	112-119 cm	99-107 cm	—	—
785 758	60 / 62	186-191 cm	120-127 cm	108-117 cm	—	—
785 759	64 / 66	190-197 cm	128-135 cm	118-132 cm	—	—

Passive Arc Fault Protection – DEHNcare®

Arc-fault-tested Protective Coat

- Reinforced stand-up collar
- Useful side arm pockets
- Zip and hook-and-loop fasteners

General Information:			
Direct incident energy (E_{i0})	(class 2 / 7 kA, 500 ms) 423 kJ / m ²		
Extended direct incident energy (E_{i0})	(class 2*) 1050 ... 1390 kJ / m ²		
Arc energy (W_{arc})	318 kJ		
ATPV (Arc Thermal Performance Value)	33.1 cal / cm ²		
Type	APC 48 50	APC 52 54	APC 56 58
Part No.	785 755	785 756	785 757
Size (international)	48 / 50 (M)	52 / 54 (L)	56 / 58 (XL)
Type	APC 60 62		APC 64 66
Part No.	785 758		785 759
Size (international)	60 / 62 (XXL)		64 / 66 (3XL)



*) The distance of the specimen was reduced from 300 mm to 150 mm based on IEC 61482-1-2.

In case of very heavy soiling, the protective coat can be dry cleaned by a specialist leather cleaner.

Arc-fault-tested Protective Jacket

- Reinforced stand-up collar
- Useful side arm pockets
- Zip and hook-and-loop fastener

General Information:				
Direct incident energy (E_{i0})	(class 2 / 7 kA, 500 ms) 423 kJ / m ²			
Extended direct incident energy (E_{i0})	(class 2*) 1050 ... 1390 kJ / m ²			
Arc energy (W_{arc})	318 kJ			
ATPV (Arc Thermal Performance Value)	33.1 cal / cm ²			
Type	APJ 46	APJ 48	APJ 50	APJ 52
Part No.	785 769	785 770	785 771	785 772
Size (international)	46 (XS)	48 (S)	50 (M)	52 (L)
Type	APJ 54	APJ 56	APJ 58	
Part No.	785 773	785 774	785 775	
Size (international)	54 (XL)	56 (XXL)	58 (3XL)	



*) The distance of the specimen was reduced from 300 mm to 150 mm based on IEC 61482-1-2.

In case of very heavy soiling, the protective jacket can be dry cleaned by a specialist leather cleaner.

Arc-fault-tested Protective Trousers

- Knee pads and pair of braces included
- Pockets for knee pads
- Adjustable belt

General Information:				
Direct incident energy (E_{i0})	(class 2 / 7 kA, 500 ms) 423 kJ / m ²			
Extended direct incident energy (E_{i0})	(class 2*) 1050 ... 1390 kJ / m ²			
Arc energy (W_{arc})	318 kJ			
ATPV (Arc Thermal Performance Value)	29.2 cal / cm ²			
Type	APT 46	APT 48	APT 50	APT 52
Part No.	785 779	785 780	785 781	785 782
Size (international)	46 (XS)	48 (S)	50 (M)	52 (L)
Type	APT 54	APT 56	APT 58	
Part No.	785 783	785 784	785 785	
Size (international)	54 (XL)	56 (XXL)	58 (3XL)	



*) The distance of the specimen was reduced from 300 mm to 150 mm based on IEC 61482-1-2.

In case of very heavy soiling, the protective trousers can be dry cleaned by a specialist leather cleaner.

Accessories for DEHNcare® APJ, APT and APC

Pair of braces (1)

For arc-fault-tested protective trousers with four hook-and-loop fasteners.

Type	APA B
Part No.	785 788
Colour	Black ●

Knee pads (2)

For arc-fault-tested protective trousers, to be inserted into the lining of the trouser legs (slit pockets).

Type	APA KP
Part No.	785 789
Material	Foam

Passive Arc Fault Protection – DEHNcare®

DEHNcare® APG



Actuation of an NH fuse puller using protective gloves.



IEC 61482-1-2:2007
class 2
IEC 61482-1-1:2007
ATPV 32.8 cal/cm²

EN 407:2004



4 X 3 X X X

EN 388:2003



2 1 3 3

General Information:

Standard	Box test in accordance with IEC 61482-1-2; ATPV test in accordance with IEC 61482-1-1; DIN EN 388, DIN EN 407
Material (glove palm)	Siliconised calf grain leather
Material (glove back)	100% Kevlar® interlock knit
Material (sewing thread)	Kevlar®

Notes

Article 5 of the German Occupational Health and Safety Act requires employers to perform a hazard analysis.

This hazard analysis also involves arc fault protection.

Employers must select and provide approved protective clothing including helmets, face shields and gloves to protect personnel against the hazards of arc faults.

They must also ensure that each employee who is exposed to the hazards of arc faults wears protective clothing.

Protective gloves of type APG are no insulating gloves in accordance with EN/IEC 60903 (DIN VDE 0682-311) for live working.

Measure correctly



Glove size

Measure the circumference around your knuckles to determine your correct glove size.

Example

For a knuckle circumference of 24 cm, you would choose a size 10.

Glove size

Size	Circumference around your knuckles
8 (M)	20.3 cm
9 (L)	22.9 cm
10 (XL)	25.4 cm
11 (XXL)	27.9 cm
12 (3XL)	30.5 cm

Arc-fault-tested Protective Gloves

General Information:

Direct incident energy (E_{i0})	(class 2 / 7 kA, 500 ms) 423 kJ / m ²
Extended direct incident energy (E_{i0})	(class 2*) 1050 ... 1390 kJ / m ²
Arc energy (W_{arc})	318 kJ
ATPV (Arc Thermal Performance Value)	32.8 cal / cm ²
Gauntlet length	100 mm



Type APG ...	8	9	10	11	12
Part No.	785 796	785 797	785 798	785 799	785 800
Total length	310 mm	320 mm	330 mm	340 mm	350 mm
Size (international)	8 (M)	9 (L)	10 (XL)	11 (XXL)	12 (3XL)

*) The distance of the specimen was reduced from 300 mm to 150 mm based on IEC 61482-1-2.

Arc-fault-tested Protective Gloves with Long Gauntlet

General Information:

Direct incident energy (E_{i0})	(class 2 / 7 kA, 500 ms) 423 kJ / m ²
Extended direct incident energy (E_{i0})	(class 2*) 1050 ... 1390 kJ / m ²
Arc energy (W_{arc})	318 kJ
ATPV (Arc Thermal Performance Value)	32.8 cal / cm ²
Gauntlet length	230 mm



Type APG ...	8 L	9 L	10 L	11 L	12 L
Part No.	785 808	785 809	785 810	785 811	785 812
Total length	430 mm	440 mm	450 mm	460 mm	470 mm
Size (international)	8 (M)	9 (L)	10 (XL)	11 (XXL)	12 (3XL)

*) The distance of the specimen was reduced from 300 mm to 150 mm based on IEC 61482-1-2.

Passive Arc Fault Protection – DEHNcare®

DEHNcare® APHO

Protective hood

In case of an arc fault the DEHNcare® protective hood in combination with the safety helmet for electricians provides:

- Frontal protection in case of direct incident energy from the switchgear (zone 1 = heat shield)
- Secondary protection in case of indirect incident energy, e.g. in case of energy reflection from the side and from the back (zone 2 = all-around protection)
- Protection against bursting off or falling down parts (zone 3)



All-round protection for face, head and neck with 3-zone protective system.

General Information:

Standard	EN 166 and EN 170, GS-ET-29; box test acc. to IEC 61482-1-2; ATPV test acc. to IEC 61482-1-1
----------	--



IEC 61482-1-2:2007
class 2
IEC 61482-1-1:2007
ATPV 37.2 cal/cm²

Zone 1

Frontal protection against the direct frontal incident energy from the switchgear

Zone 2

Secondary protection against the reflected energy from the side or from the back

Zone 3

Protection against bursting off or falling down parts

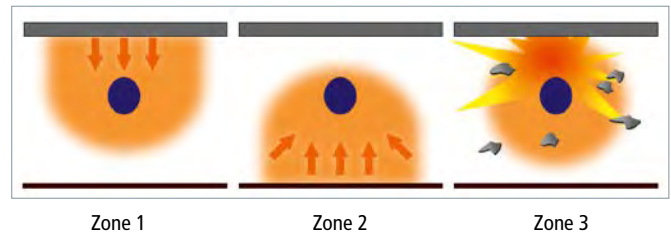

Arc-fault-tested Protective Hood

Note: Safety helmet for electricians ESH U S is not included in delivery!

Type	APHO
Part No.	785 760
Nominal voltage up to (U _N)	1000 V
Material	plastic, neoprene, leather
Incident energy after box test	(class 2 / 7 kA, 500 ms) 423 kJ / m ²
Arc thermal performance value (ATPV)	37.2 cal / cm ²
Visible light transmittance (VLT)	29.1 ... 43.2 %



Accessories for DEHNcare® APHO

Visor holder with clip

For arc-fault-tested face shields with clip; APS CL2 SC / APS 12C SC.

Type	VH SC APS
Part No.	785 753
Material	Nylon



Arc-fault-tested protective visor

For use with the arc-fault-tested protective hood APHO.

Type	APS HO
Part No.	785 754
Nominal voltage (U _N)	1000 V
Material	Plastic
ATPV value	37.2 cal / cm ²
Visible light transmittance (VLT)	29.1 ... 43.2 %

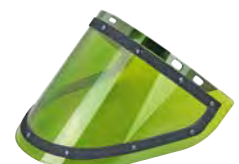

Passive Arc Fault Protection – DEHNcare®

ESH U S Safety Helmet for Electricians



Nominal voltages up to 1000 V

- With slot for APS ... SC face shield
- Adjustable to head sizes from 52 to 61 cm via push / rotary knob
- Six-point suspension with sweatband
- ABS plastic shell

General Information:

Standard	EN 397 and EN 50365
----------	---------------------

ESH U S

Safety helmet with short peak

General Information:

Nominal voltage up to (U _N)	1000 V
Material	ABS plastics



Type ESH U 1000 S ...	SY	SW	SO
Part No.	785 705	785 706	785 707
Colour	Yellow ●	White ○	Orange ●
Type ESH U 1000 S ...	SB	SR	
Part No.	785 708	785 709	
Colour	Blue ●	Red ●	

Accessories for ESH U S Safety Helmet for Electricians



Chin strap

For safety helmets for electricians ESH U S 1000, adjustable.

Type	KR ESH U 1000
Part No.	785 738
Colour	Black ●



Sweat band

Replacement part for ESH U S safety helmet for electricians.
1 set = 10 pieces

Type	SB ESH U 1000
Part No.	785 739
Material	Hydro-flock (S31F) PVC (S31P)
PU	10 pc(s).



LED Head torch

- Fits the slot of the ESH US safety helmet for electricians, in connection with face shield APS CL1 MEHA and APS CL2 MAHA
- With two separate reflectors for distance and area lighting, with 4 switching steps
- Two charging options: micro USB or charging cradle. Charging unit with with charging cradle included in delivery

Type	LED HL ESH
Part No.	785 723
Degree of protection	IP 67
Light current max.	115 lumens

Passive Arc Fault Protection – DEHNcare®

DEHNcare® APS

Face shields

Prevent injuries – Stay healthy

- Protection even if scratched
- Anti-mist
- Cost saving long service life
- Transparent chin protector provides all-round visibility



Cleaning a low-voltage switchgear using adequate personal protective equipment.

General Information:

Standard	EN 166 and EN 170, GS-ET-29; box test according to IEC 61482-1-2; ATPV test according to IEC 61482-1-1; ASTM F2178
----------	---

Arc-fault-tested Face Shield with Clip and Transparent Chin Protector

- Fits the slot in the ESH U S safety helmet for electricians

Type APS ...	T CL2 SC	T 12C SC	T 20C SC
Part No.	785 761	785 762	785 763
Nominal voltage up to (U _N)	1000 V	1000 V	1000 V
Material	Plastic	Plastic	Plastic
Thickness	1.5 mm	1.5 mm	1.5 mm
Incident energy after box test	(class 2 / 7 kA, 500 ms) 423 kJ / m ²	(class 2 / 7 kA, 500 ms) 423 kJ / m ²	(class 2 / 7 kA, 500 ms) 423 kJ / m ²
Arc thermal performance value (ATPV)	—	12 cal / cm ²	20 cal / cm ²
Visible light transmittance (VLT)	>> 75 %	58.1 ... 74.4 %	43.2 ... 58.1 %



Arc-fault-tested Face Shield with Strap and Transparent Chin Protector

- Suitable for all standard safety helmets for electricians

Type APS ...	T CL2 FS	T 12C FS	T 20C FS
Part No.	785 764	785 765	785 766
Nominal voltage up to (U _N)	1000 V	1000 V	1000 V
Material	Plastic	Plastic	Plastic
Thickness	1.5 mm	1.5 mm	1.5 mm
Incident energy after box test	(class 2 / 7 kA, 500 ms) 423 kJ / m ²	(class 2 / 7 kA, 500 ms) 423 kJ / m ²	(class 2 / 7 kA, 500 ms) 423 kJ / m ²
Arc thermal performance value (ATPV)	—	12 cal / cm ²	20 cal / cm ²
Visible light transmittance (VLT)	>> 75 %	58.1 ... 74.4 %	43.2 ... 58.1 %



Arc-fault-tested Face Shield with Clip and Chin Protector

- Fits the slot in the ESH U S safety helmet for electricians

Type APS ...	CL2 SC	12C SC
Part No.	785 746	785 747
Nominal voltage up to (U _N)	1000 V	1000 V
Material	Plastic	Plastic
Thickness	1.5 mm	1.5 mm
Incident energy after box test	(class 2 / 7 kA, 500 ms) 423 kJ / m ²	(class 2 / 7 kA, 500 ms) 423 kJ / m ²
Arc thermal performance value (ATPV)	—	12 cal / cm ²
Visible light transmittance (VLT)	> 75 %	65 ... 75 %



Arc-fault-tested Face Shield with Strap and Chin Protector

- Suitable for all standard safety helmets for electricians

Type APS ...	CL2 FS	12C FS
Part No.	785 748	785 749
Nominal voltage up to (U _N)	1000 V	1000 V
Material	Plastic	Plastic
Thickness	1.5 mm	1.5 mm
Incident energy after box test	(class 2 / 7 kA, 500 ms) 423 kJ / m ²	(class 2 / 7 kA, 500 ms) 423 kJ / m ²
Arc thermal performance value (ATPV)	—	12 cal / cm ²
Visible light transmittance (VLT)	> 75 %	65 ... 75 %



Passive Arc Fault Protection – DEHNcare®

Arc-fault-tested Face Shield with Mechanical Lever Arm

- Fits the slot in the safety helmet for electricians ESH U S



Type APS ...	CL1 MEHA
Part No.	785 721
Nominal voltage up to (U _N)	1000 V
Colour	transparent
Material	polycarbonate
Thickness	approx. 2 mm
Incident energy after box test	(class 1 / 4 kA, 500 ms) 135 kJ / m ²
Visible light transmittance (VLT)	≥ 75 %

Arc-fault-tested Face Shield with Magnetic Lever Arm

- Fits the slot of the safety helmet for electricians ESH U S



Type APS ...	CL2 MAHA
Part No.	785 722
Nominal voltage up to (U _N)	1000 V
Colour	blue
Material	polycarbonate
Thickness	approx. 2 mm
Incident energy after box test	(class 2 / 7 kA, 500 ms) 423 kJ / m ²
Visible light transmittance (VLT)	50 ... 75 %

Accessories for DEHNcare® APS

Visor holder with clip

For arc-fault-tested face shields with clip; APS CL2 SC / APS 12C SC.



Type	VH SC APS
Part No.	785 753
Material	Nylon

Microfibre Bag

For cleaning and storing the DEHNcare APS face shields.



Type	MFB APS
Part No.	785 724
Suitable for	DEHNcare APS
Dimension	450 x 400 mm
Colour	Black ●

Active Arc Fault Protection

DEHNshort – Active Arc Fault Protection System

- Protection of persons and installations and function in accordance with DIN EN 61439-2, Suppl. 1 (IEC/TR 61641 ed. 3, 2014)
- Maximum availability of installations
- Modular system design
- System status is indicated at the front of the installation

General Information:	
Rated operating voltage (Ue)	DSRT QD: 400 V AC; DSRT QD II: 690 V AC
Rated short-time withstand current of the quenching devices (Icw)	DSRT QD: 80 kA, 50 ms; DSRT QD II: 110 kA, 300 ms
Lower response threshold (I _{parc})	5 kA
Max. admissible ambient temperature of the point sensors (during operation)	-20 °C ... +85 °C
Max. admissible ambient temperature of the fibre-optic sensors (during operation)	-5 °C ... +85 °C
Max. admissible ambient temperature of the quenching devices (during operation)	-5 °C ... +70 °C
Typical arc fault extinction times (t _b)	DSRT QD: < 2-3 ms at 80 kA; DSRT QD II: < 3-4 ms at 100 kA

DEHNshort optimally protects persons and switchgear installations from the effects of an arc fault. To achieve this, particularly short response times are required in high-energy switchgear installations. Just a few milliseconds are decisive for the intensity and the effects of an arc fault. DEHNshort detects the arc fault the moment it starts to develop, evaluates the detected sensor signals and quenches the arc fault by generating a three-phase bolted short-circuit.

Functional principle:

Detection

The protection transformers situated upstream of the feeder circuit breakers detect the overcurrent resulting from the arc fault in all infeeds. Special light sensors detect the extremely bright light of the arc fault. Depending on the requirements of the relevant switchgear installation, light sensors are available as point sensors or fibre optic sensors.

Evaluation

Electronic detection devices link the sensor signals and activate the quenching devices of the relevant busbar as well as the shunt releases of all feeder circuit breakers in case of both detection parameters.



DEHNshort – active arc fault protection system

Quenching

As soon as the quenching devices are activated, a bolted short-circuit is generated in parallel to the arc fault within a short period of time. Due to this low-impedance bypass, the voltage drops and the arc fault is quenched immediately. Thyristors short-circuit the three phases of the busbar directly after the quenching devices have been activated. Subsequently, a spring-driven contact system carries the short-circuit current until the installation is disconnected by the feeder circuit breakers.

Isolation

To ensure that the switchgear installation is not loaded with the short-circuit current for longer than necessary – and to ensure additional safety – a disconnection command is transmitted to the relevant shunt release of all feeder circuit breakers via floating contacts. This means that the busbar section where the arc fault occurred is already isolated from the system.

Re-commissioning

The switchgear installation can be immediately re-commissioned after the fault has been rectified, the quenching devices have been replaced and an isolation test has been carried out. The arc fault protection system significantly exceeds the requirements of test criteria 1-7 of IEC TR 61641 ed3 of 2014. DEHNshort is used wherever the protection of persons and availability of the power supply is vital.



Built-in protection transformers



Built-in light sensors



Detection devices integrated in the door



Quenching device above the supply switch

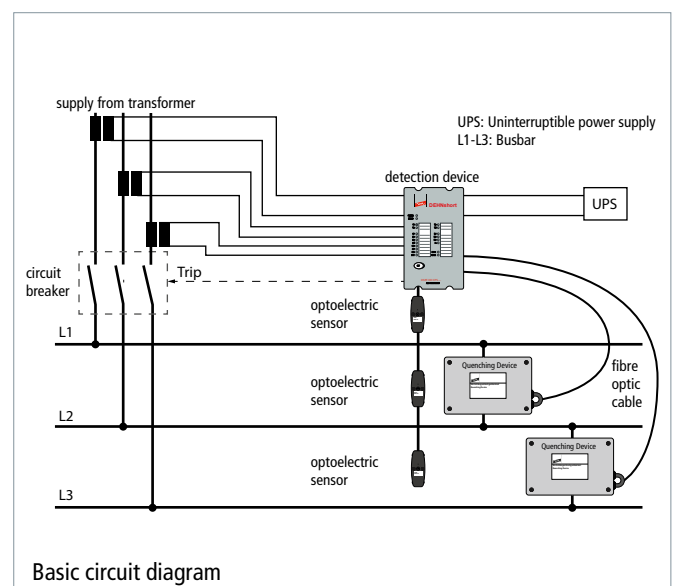

Active Arc Fault Protection

Detection Device (Current + Light)

DSRT DD CPS detection device for current and light detection (DSRT PS point sensors) including output for directly connecting two DSRT QD / DSRT QD II quenching devices.



Type DSRT ...	DD CPS BACA	DD CPS AACA
Part No.	782 030	782 031
Min. / max. voltage (U _N)	18-72 V d.c.	92-265 V AC / DC
Degree of protection (front side)	IP 50	IP 50
Degree of protection (rear side)	IP 20	IP 20
Dimensions of the front plate (H x W)	177 x 102 mm	177 x 102 mm
Mounting dimensions (H x W x D)	157 x 82 x 164 mm	157 x 82 x 164 mm
Sensor inputs	S1, S2, S3, S4 (3 sensors (DSRT PS) can be connected per channel)	S1, S2, S3, S4 (3 sensors (DSRT PS) can be connected per channel)
Current inputs	1 A / 5 A (IL1, IL2, IL3, Io)	1 A / 5 A (IL1, IL2, IL3, Io)
Binary inputs	24 V d.c., 3 mA (BI1, BI2)	24 V d.c., 3 mA (BI1, BI2)
Tripping relay	Up to 250 V a.c./d.c. 5 A (T1, T2, T3, T4)	Up to 250 V a.c./d.c. 5 A (T1, T2, T3, T4)
High-speed outputs	Up to 250 V a.c./d.c. 2 A (HS01, HS02)	Up to 250 V a.c./d.c. 2 A (HS01, HS02)
Quenching device outputs	Optical fibre cable (at least 43 mA) (2x TX)	Optical fibre cable (at least 43 mA) (2x TX)
Binary output	24 V d.c. 20 mA (B01)	24 V d.c. 20 mA (B01)
Operating temperature (T _U)	-35 °C ... +70 °C	-35 °C ... +70 °C
Tripping time of the relay	7 ms	7 ms
Tripping time HSO	< 2 ms	< 2 ms
Tripping time TX	< 2 ms	< 2 ms
Arc fault quenching time	< 2-3 ms with DSRT QD / < 3-4 ms with DSRT QD II	< 2-3 ms with DSRT QD / < 3-4 ms with DSRT QD II
Approvals	VdS	VdS

Detection Device (Point Sensor)

DSRT DD PS detection device for light detection (DSRT PS point sensors) including output for directly connecting two DSRT QD / DSRT QD II quenching devices.



Type DSRT ...	DD PS BACA	DD PS AACA
Part No.	782 040	782 041
Min. / max. voltage (U _N)	18-72 V d.c.	92-265 V AC / DC
Degree of protection (front side)	IP 50	IP 50
Degree of protection (rear side)	IP 20	IP 20
Dimensions of the front plate (H x W)	177 x 52 mm	177 x 52 mm
Mounting dimensions (H x W x D)	157 x 45 x 164 mm	157 x 45 x 164 mm
Sensor inputs	S1, S2, S3, S4 (3 sensors (DSRT PS) can be connected per channel)	S1, S2, S3, S4 (3 sensors (DSRT PS) can be connected per channel)
Binary inputs	24 V d.c., 3 mA (BI1, BI2)	24 V d.c., 3 mA (BI1, BI2)
Tripping relay	Up to 250 V a.c./d.c. 5 A (T1, T2, T3, T4)	Up to 250 V a.c./d.c. 5 A (T1, T2, T3, T4)
Quenching device outputs	Optical fibre cable (at least 43 mA) (2x TX)	Optical fibre cable (at least 43 mA) (2x TX)
Binary output	24 V d.c. 20 mA (B01)	24 V d.c. 20 mA (B01)
Operating temperature (T _U)	-35 °C ... +70 °C	-35 °C ... +70 °C
Tripping time of the relay	7 ms	7 ms
Tripping time TX	< 2 ms	< 2 ms
Arc fault quenching time	< 2-3 ms with DSRT QD / < 3-4 ms with DSRT QD II	< 2-3 ms with DSRT QD / < 3-4 ms with DSRT QD II
Approvals	VdS	VdS

Detection Device (Fibre Optic Sensor)

DSRT DD FS detection device for light detection (DSRT FS fibre optic sensor).



Type DSRT ...	DD FS BAAA	DD FS AAAA
Part No.	782 050	782 051
Min. / max. voltage (U _N)	18-72 V d.c.	92-265 V AC / DC
Degree of protection (front side)	IP 50	IP 50
Degree of protection (rear side)	IP 20	IP 20
Dimensions of the front plate (H x W)	177 x 52 mm	177 x 52 mm
Mounting dimensions (H x W x D)	157 x 45 x 164 mm	157 x 45 x 164 mm
Sensor inputs	S1, S2, S3 (one fibre optic sensor (DSRT FS) can be connected per channel)	S1, S2, S3 (fibre optic sensor (DSRT FS) can be connected per channel)
Binary inputs	24 V d.c., 3 mA (BI1, BI2)	24 V d.c., 3 mA (BI1, BI2)
Tripping relay	Up to 250 V a.c./d.c. 5 A (T1, T2, T3, T4)	Up to 250 V a.c./d.c. 5 A (T1, T2, T3, T4)
Binary output	24 V d.c. 20 mA (B01)	24 V d.c. 20 mA (B01)
Operating temperature (T _U)	-35 °C ... +70 °C	-35 °C ... +70 °C
Tripping time of the relay	7 ms	7 ms
Arc fault quenching time	< 2-3 ms with DSRT QD / < 3-4 ms with DSRT QD II	< 2-3 ms with DSRT QD / < 3-4 ms with DSRT QD II
Approvals	VdS	VdS

Active Arc Fault Protection

Point Sensor

DSRT PS point sensor for arc detection. Serial connection of max. 3 sensors at each sensor input of DSRT DD CPS and DSRT DD PS devices.

Type DSRT ...	PS
Part No.	782 060
Dimensions (L x W x H)	90 x 32.8 x 19.5 mm
Fixing holes	2x 3.2 mm
Lower response threshold (I_{parc})	5 kA
Detection radius	90° (180°)
Max. distance to the arc fault	max. 2 m (0.5 m)
Sensor wiring	Two cores and shielding
Sensor cable specification	Twisted pair max. 0,5 mm ² , shielded
Max. sensor cable length per sensor cable	100 m
Degree of protection	IP 60
Operating temperature (T_u)	-20 °C ... +85 °C
Approvals	VdS



Fibre Optic Sensor

DSRT FS fibre optic sensor for arc detection. Connection of one sensor at each sensor input of DSRT DD FS devices.

Type DSRT ...	FS 8 1.5	FS 10 1.5	FS 12 1.5	FS 15 1.5
Part No.	782 077	782 081	782 085	782 091
Sensor length	8 m	10 m	12 m	15 m
Active sensor length	5 m	7 m	9 m	12 m
Diameter	1.2 mm	1.2 mm	1.2 mm	1.2 mm
Bending radius	50 mm	50 mm	50 mm	50 mm
Lower response threshold (I_{parc})	5 kA	5 kA	5 kA	5 kA
Detection radius	360°	360°	360°	360°
Max. distance to the arc fault	max. 10 cm	max. 10 cm	max. 10 cm	max. 10 cm
Operating temperature (T_u)	-5 °C ... +85 °C	-5 °C ... +85 °C	-5 °C ... +85 °C	-5 °C ... +85 °C



Accessories for Fibre Optic Sensor

Foam rubber

For fibre optic sensors DSRT FS.

Type	DSRT SR D8 L20
Part No.	782 098
Length	20 mm
Diameter	8 mm
PU	50 pc(s)



Fixing clip

For fibre optic sensors DSRT FS.

Type	DSRT FC D8
Part No.	782 099
Diameter	8 mm
Mounting bore	Ø6.5 mm
PU	50 pc(s)



Active Arc Fault Protection

Quenching Device QD

Quenching device for direct connection to DSRT DD CPS and DSRT DD PS detection devices.



Type DSRT ...	QD
Part No.	782 000
Rated operating voltage (U_e)	400 V AC, 50 Hz
Rated short-time withstand current (I_{cw})	80 kA, 50 ms
Rated peak withstand current (I_{pk})	176 kA
Dimensions (H x W x D)	107 x 186 x 180 mm
System configurations	TN, TT
Degree of protection	IP 00
Approvals	VdS

Quenching Device QD II

Quenching device unit for direct connection to DSRT DD CPS and DSRT DD PS detection devices.



Type DSRT ...	QD II
Part No.	782 002
Rated operating voltage (U_e)	690 V AC, 50 Hz
Rated short-time withstand current (I_{cw})	110 kA, 300 ms
Rated peak withstand current (I_{pk})	242 kA
Dimensions (H x W x D)	177 x 120 x 180 mm
System configurations	TN, TT
Degree of protection	IP 00
Approvals	VdS

Fibre Optic Cable

Prewired fibre optic cables for connecting DSRT DD CPS, DSRT DD PS detection devices and DSRT QD quenching device units.
1 set = 2 pieces



Type DSRT ...	LWL 0.75	LWL 2.00	LWL 4.00	LWL 8.00
Part No.	782 020	782 022	782 024	782 028
Length	0.75 m	2 m	4 m	8 m
Diameter	2.2 mm	2.2 mm	2.2 mm	2.2 mm
Approvals	VdS	VdS	VdS	VdS



Products for Protection against High-pressure Water Jet

Products for Protection against High-pressure Water Jet

Reliable protection when working with high-pressure water jets up to 1000 bar

Working with high-pressure water jets, represents a special hazard for workers. To prevent accidents caused by the enormous penetrating power of the water, DEHN has developed a protective overall made of a special material mix.

Prevention of cuts and lacerations – one worry less!

The 2-layered composite material is breathable, waterproof and cut-resistant. The material mix also offers mechanical safety, i.e., it is abrasion and tear resistant. This makes it possible to prevent cuts and accompanying wound infections which otherwise pose a considerable risk when working with high-pressure water jets.



Safety bonus

The protective overall has been tested at up to 1,000 bars and is resistant to high pressure. Increased protection against abrasions and cuts is provided for those areas



Untroubled work

The 2-layer composite material is watertight and cut-resistant yet still breathable. For a **high degree of comfort**.



A true lightweight

The overall only weighs 2.3 kg and is therefore **especially light**. You have **freedom of movement** and **mobility** whatever the job.

Extra protection for the parts of the body at greatest risk

The DEHNcare® WJP overall has special protection zones and reinforced arm and leg protectors to guard those parts of the body which have the greatest exposure to high-pressure water jets.

DEHNcare® WJP (Water Jet Protection) is the first protective overall against high-pressure water jets tested and certified according to GS-IFA-P15 principles for testing and certifying personal protective equipment (PPE) and to the new EU regulation 2016/425.



Soon ready for use again

The overall can be **washed at 60 degrees** or **dry cleaned**. **Conserve environmental resources**: The overall is reusable, so you need **fewer disposable**.



Now with branding service:

Make your brand visible at your customer on site! Individualise your PPE (from 10 items off) with company logo and name of the wearer.

The overall made of a new material combination offers protection when working with high-pressure water jets in a variety of areas.

- Cleaning of industrial plants
- Cleaning public facilities and spaces
- Stripping paint off metal surfaces, e.g. bridges or monuments
- Cleaning machinery and vehicles, e.g. in the fields of construction, agriculture and transport
- Concrete cleaning and refurbishment



Products for Protection against High-pressure Water Jet

DEHNcare® WJP

Protective overall against high-pressure water jets

- High-pressure resistant up to 1000 bar (tested with flat-jet nozzle according to the test principles GS-IFA-P15)
- Completely waterproof – including the seams
- Breathable, thus comfortable to wear
- Great freedom of movement due to especially light material
- Environmentally friendly – washable up to 60°



The first protective overall against high-pressure water jets to correspond to the test principles GS-IFA-P15 is breathable and a lightweight and thus especially comfortable to wear.



Attachable hood



Helmet, visor and earmuffs



Replaceable arm and leg protectors

NEW

Protective Overall Against High-pressure Water Jets

Protective overall against high-pressure water jets, complete with arm and leg protectors.

General Information:			
High-pressure resistant	≤ 1000 bar		
Material	multilayer laminate		
Type	breathable and waterproof (class 3 according to EN 343)		
Standards / test principles	EN 343, EN 13034 (type 6), GS-IFA-P15		
Test parameters according to GS-IFA-P15	flat jet nozzle type B		
– Distance (nozzle – surface of test sample)	7.5 cm		
– Angle (high-pressure water jet)	15 °		
– Speed (feed)	0.5 m/s		
– Quantity of water (high-pressure water jet)	22 l/min		
– Pressure (high-pressure water jet)	1200 bar*		
Type WJP OC ...	S	M	L
Part No.	786 741 ^{NEW}	786 742 ^{NEW}	786 743 ^{NEW}
Size	48 (S)	50 (M)	52 (L)
Type WJP OC ...	XL	XXL	3XL
Part No.	786 744 ^{NEW}	786 745 ^{NEW}	786 746 ^{NEW}
Size	54 (XL)	56 (XXL)	58 (3XL)



Water Jet Protection

*) The test for protection against penetration of high-pressure water jets is performed with a safety factor of 1.2.

Accessories for DEHNcare® WJP

Hood

Hood for protective overall against high-pressure water jets.

Type	WJP O H
Part No.	786 770 ^{NEW}
Fastening	by means of press buttons



Products for Protection against High-pressure Water Jet

Spare Parts for DEHNcare® WJP



Overall

Overall without arm and leg protectors.

- Reflectors for better visibility
- Two-way zip

General Information:	
High-pressure resistant	≤ 1000 bar
Material	multilayer laminate
Type	breathable and waterproof (class 3 according to EN 343)
Standards / test principles	EN 343, EN 13034 (Type 6), GS-IFA-P15*

Type	WJP O S	WJP O M	WJP O L
Part No.	786 751 ^{NEW}	786 752 ^{NEW}	786 753 ^{NEW}
Size	48 (S)	50 (M)	52 (L)

Type	WJP O XL	WJP O XXL	WJP O 3XL
Part No.	786 754 ^{NEW}	786 755 ^{NEW}	786 756 ^{NEW}
Size	54 (XL)	56 (XXL)	58 (3XL)

*) Only in conjunction with arm and leg protectors of corresponding size.

Arm protectors

Arm protectors (set) for protective overall against high-pressure water jets.

- Increased protection against cuts and puncture wounds
- Reflectors for better visibility
- Silver popper – to start with buttoning

General Information:	
High-pressure resistant	≤ 1000 bar
Material	para-aramid fabric with polymer coating
Type	breathable and waterproof (class 3 according to EN 343)
Standards / test principles	EN 343, EN 13034 (Type 6), GS-IFA-P15*

Type	WJP O AP S	WJP O AP M	WJP O AP L
Part No.	786 761 ^{NEW}	786 762 ^{NEW}	786 763 ^{NEW}
Size	48 (S)	50 (M)	52 (L)

Type	WJP O AP XL	WJP O AP XXL	WJP O AP 3XL
Part No.	786 764 ^{NEW}	786 765 ^{NEW}	786 766 ^{NEW}
Size	54 (XL)	56 (XXL)	58 (3XL)

*) Only in conjunction with overall of corresponding size.

Leg protectors

Leg protectors (set) for protective overall against high-pressure water jets.

- Increased protection against cuts and puncture wounds
- Reflectors for better visibility
- Silver popper – to start with buttoning

General Information:	
High-pressure resistant	≤ 1000 bar
Material	para-aramid fabric with polymer coating
Type	breathable and waterproof (class 3 according to EN 343)
Standards / test principles	EN 343, EN 13034 (Type 6), GS-IFA-P15*

Type	WJP O LP S	WJP O LP M	WJP O LP L
Part No.	786 781 ^{NEW}	786 782 ^{NEW}	786 783 ^{NEW}
Size	48 (S)	50 (M)	52 (L)

Type	WJP O LP XL	WJP O LP XXL	WJP O LP 3XL
Part No.	786 784 ^{NEW}	786 785 ^{NEW}	786 786 ^{NEW}
Size	54 (XL)	56 (XXL)	58 (3XL)

*) Only in conjunction with an overall of the corresponding size.



Products for Protection against High-pressure Water Jet

Accessories for DEHNcare® WJP

ESH U Safety helmet for electricians

General Information:			
Material	ABS plastic		
Standard	EN 397 and EN 50365		
Type	ESH U 1000 S SY	ESH U 1000 S SW	ESH U 1000 S SO
Part No.	785 705	785 706	785 707
Colour	yellow ●	white ○	orange ●
Type	ESH U 1000 S SB		ESH U 1000 S SR
Part No.	785 708		785 709
Colour	blue ●		red ●



Face shield with mechanical lever arm

Fits the slot of the ESH U S safety helmet for electricians

Type	APS CL1 MEHA
Part No.	785 721
Colour	transparent
Material	polycarbonate



Earmuffs

For attaching to the face shield with mechanical lever arm according to EN 352-3.

- Pleasant to wear due to extra soft surface texture
- Comfortable protection in case of long-term application
- Turnable by 360°

Type	HKGH ESH MEHA
Part No.	786 799
SNR value	27 dB



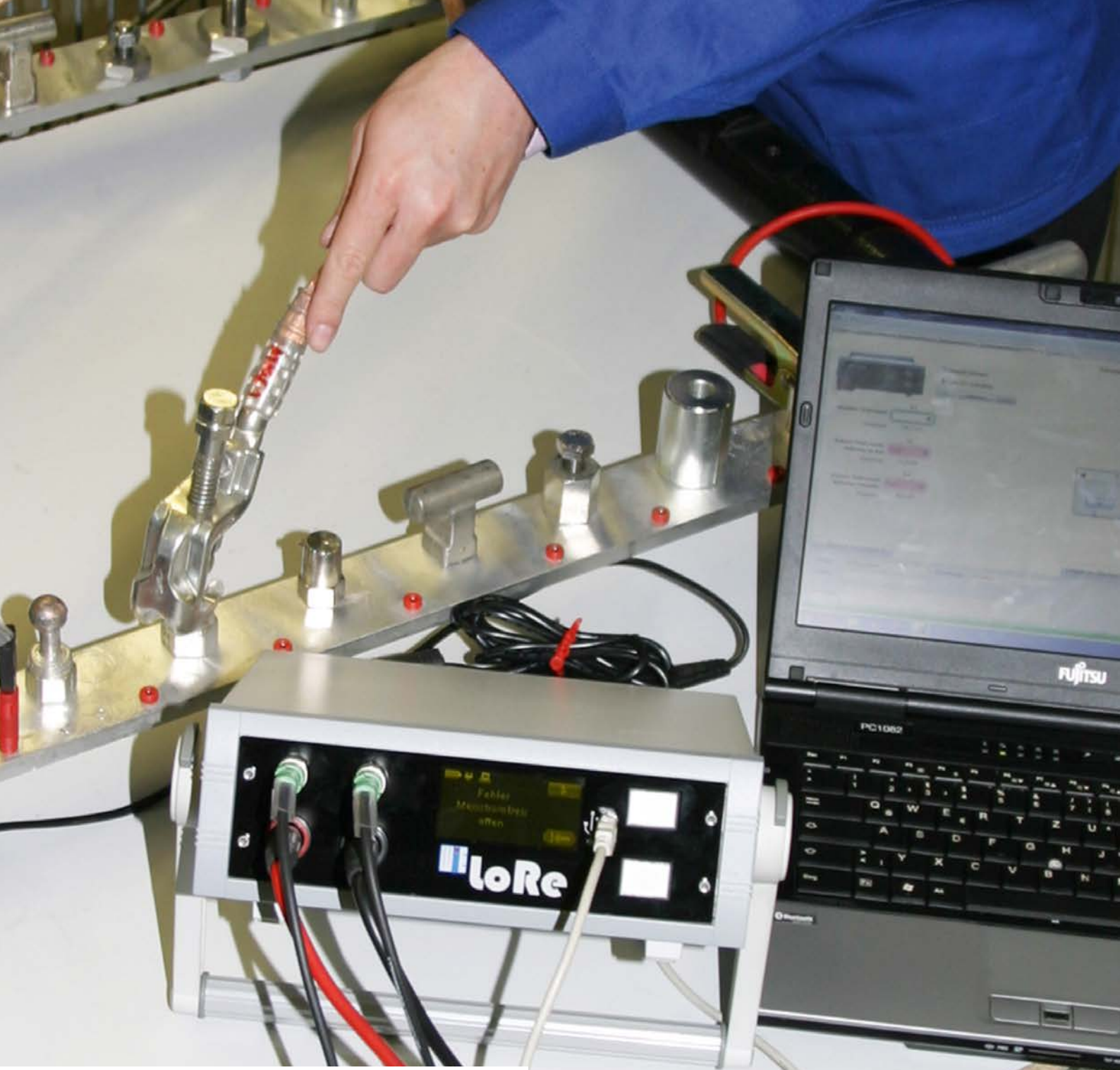

DEHN protects.®

Periodic Testing of Safety Devices at DEHN

Maintenance Test

Only tested devices protect your life

- Regular maintenance tests ensure that your devices are in a good order and condition
- Maintenance tests in DEHN's high-voltage test laboratory for operating and earthing sticks, voltage detectors, phase comparators, devices for voltage detecting systems, earthing and short-circuiting devices
- Test is documented on the device and in a separate test report



One of our high-voltage laboratories.

Voltage Detector Retest > 1 kV to IEC/EN 61243-1

Test Report No.: PHEC 005856 20131002



DETAILED INFORMATION ON THE UNIT

Voltage detector type: PHE III	Nominal voltage: 20KV	
Art.-No.: 767720	Man.-No.: 005856	Year of man.: 2007
Test prod type: 767761	Man.-No.: 007051	Year of man.: 2007
Insulating rod type: 766009	Man.-No.: 010168	Year of man.: 2007

Last retest made (accord. to type label):

Notes: **repeat examination**

Customer: **John Doe**
12345 Any City, Any Street 1

Goods receipt No.: **37630** dated: **16.06.2013**

TEST IN ACCORDANCE WITH DIN VDE 0682 TEIL 411

<p>1. Test by visual inspection</p> <p>a) Orderly State <input checked="" type="checkbox"/> yes <input type="checkbox"/> no</p> <p>b) Mechanical damage <input type="checkbox"/> yes <input checked="" type="checkbox"/> no</p> <p>c) Arcing or leakage current effects <input type="checkbox"/> yes <input checked="" type="checkbox"/> no</p> <p>d) Instructions for Use <input checked="" type="checkbox"/> yes <input type="checkbox"/> no</p> <p>e) Unit complete <input checked="" type="checkbox"/> yes <input type="checkbox"/> no</p> <p>f) Markings readable <input checked="" type="checkbox"/> yes <input type="checkbox"/> no</p> <p>g) Construction visible <input checked="" type="checkbox"/> yes <input type="checkbox"/> no</p> <p>h) Red ring visible and present <input checked="" type="checkbox"/> yes <input type="checkbox"/> no</p> <p>i) Hollow parts closed <input checked="" type="checkbox"/> yes <input type="checkbox"/> no</p> <p>k) Degree of protection of indicator given (visual inspection of enclosure sealings) <input checked="" type="checkbox"/> yes <input type="checkbox"/> no</p> <p>l) Active indication signals <input checked="" type="checkbox"/> yes <input type="checkbox"/> no</p> <p>m) Self-test unit ready for operation <input checked="" type="checkbox"/> yes <input type="checkbox"/> no</p>	<p>2. Test by handling</p> <p>a) Individual parts locked against unintentional loosening <input checked="" type="checkbox"/> yes <input type="checkbox"/> no</p> <p>b) Hand guard and red ring are solidly fitted <input checked="" type="checkbox"/> yes <input type="checkbox"/> no</p> <p>3. Test by measurement</p> <p>a) Length of insulating piece as determined <input checked="" type="checkbox"/> yes <input type="checkbox"/> no</p> <p>b) Length of extension piece as determined <input checked="" type="checkbox"/> yes <input type="checkbox"/> no</p> <p>4. Test on discharge current</p> <p>Discharge current below 0,2 mA <input checked="" type="checkbox"/> yes <input type="checkbox"/> no</p> <p>5. Test on short-circuit withstand</p> <p>Short-circuits or disruptive discharges <input type="checkbox"/> yes <input checked="" type="checkbox"/> no</p> <p>6. Test for clear indication</p> <p>a) Clear indication <input checked="" type="checkbox"/> yes <input type="checkbox"/> no</p> <p>b) Clear perceptibility of visual indication <input checked="" type="checkbox"/> yes <input type="checkbox"/> no</p> <p>c) Clear perceptibility of acoustic indication <input checked="" type="checkbox"/> yes <input type="checkbox"/> no</p>
--	---

ADDITIONAL NOTES

Report number PHEC 005856 20131002

9 Volt battery changed.

The test was made with equipment, the measurement standards of which base on the standards of the Physical and Technical Federal Institute of Brunswick and Berlin (PTB) directly resp. indirectly via a German calibration facility.

ALL TESTED CHARACTERISTICS COMPLY WITH THE ABOVE MENTIONED STANDARD. THE MAINTENANCE TEST WAS PASSED SUCCESSFULLY AND WAS MARKED ON THE RATING PLATE: yes no



Marks: **2013** Next maintenance test: **2019**

9 kV AC-Measuring System D-K-15286-01-00-11018
 15 kV AC-Measuring System D-K-15103-01-00-4252
 50 kV AC-Measuring System D-K-15903-01-00-373
 100 kV AC-Measuring System D-K-15403-01-00-4251

NEUMARKT, 07.10.2013 - Meier Robert _____
 Signature of Quality Management

DEHN + SOHNE 92388 Neumarkt/OPf. www.dehn.de
 GmbH + Co. KG Postfach 16 40 Tel: 0 91 81/9 06-0
 Hamr-Dehn-Str. 1 92306 Neumarkt/OPf. Fax: 0 91 81/9 06-1100
 DEHN form No.: WPR-PHE3_REC_DD_ab 8/2006_englisch.doc

Contact

Fa. DEHN Standort 2
 Service-Center Retouren
 Am Ludwigskanal 1
 92360 Mühlhausen
 E-Mail: retoure@dehn.de

Maintenance test criteria for protective and auxiliary equipment







	DGUV regulation 3 (former BGV A3)	VDE 0105-100	Equipment standard
Earthing and short-circuiting devices	§ 5 (1) [... It shall be checked whether equipment is in good order and condition...] (2) [... at certain intervals. The intervals must be chosen so that the defects to be expected are detected in due time.]	5.3.101 [Periodic inspections, general information.]	IEC/EN 61230, Annex C (informative), C 3.2.2 [It is recommended to perform a cut test and visual inspection at least every five years in case of outdoor use and every ten years in case of indoor use.]
Voltage detectors, phase comparators and voltage detecting systems	§ 5: according to table 1C [Tests for compliance with the limit values specified in the electrotechnical rules must be carried out at least every six years.]	6.2.4 [Inspection at least before and, if possible, after each use], 5.3.101 [Periodic inspections, general information.]	IEC/EN 61243-1, Annex G (informative): Tests for capacitive voltage detectors > 1 kV [Voltage detectors that have not been subjected to a maintenance test within six years should not be used.] IEC/EN 61243-5: Tests for voltage detecting systems (VDS) IEC/EN 61481, Annex G (informative): Tests for phase comparators between 1 and 36 kV a.c. [The maximum interval between maintenance tests is six years.]
Operating and earthing sticks	§ 5: according to table 1C [A visual inspection for signs of damage and defects must be carried out prior to each use.]	5.3.101 [Periodic inspections, general information.]	VDE 0681-1 to 3: Tests for operating sticks Note: Operating sticks also have to be subjected to electrotechnical tests. DEHN recommends to use the test intervals of voltage detectors. E DIN VDE V 0681-1 to 3 Annex B (informative) [Maximum interval between maintenance tests for operating sticks is six years.]

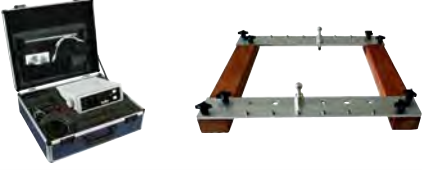

Part No.	Item
Periodic Testing of ...	
799 971	Passive voltage detector for nominal voltages up to 30 kV (all brands) *
799 950	Voltage detector for nominal voltages up to 30 kV (all brands) *
799 951	Voltage detector for nominal voltages exceeding 30 kV [up to 132 kV / 50 Hz] (all brands) *
799 952	Voltage detector for overhead contact lines for nominal voltages up to 15 kV (all brands) *
799 953	Voltage detector for voltage ranges up to 30 kV (all brands) *
799 954	Voltage detector for voltage ranges exceeding 30 kV [up to 132 kV / 50 Hz] (all brands) *
799 955	Voltage detector for voltage ranges up to 30 kV – switchable / standby / test kit (all brands) *
799 956	Voltage detector for voltage ranges exceeding 30 kV [up to 132 kV / 50 Hz] – switchable / standby (all brands) *
799 957	Distance voltage detector (D+S devices only)
799 958	Capacitive voltage detecting system (all brands) <i>Note: Passive voltage indicators are not tested!</i>
799 959	Two-pole resistive phase comparator up to 36 kV (D+S devices only) **
799 960	Single-pole capacitive phase comparator up to 36 kV (D+S devices only) *
799 961	Single-pole capacitive phase comparator (switchable) up to 36 kV (D+S devices only) *
799 962	Resistive d.c. voltage detector with one stick (D+S devices only)
799 963	Resistive d.c. voltage detector with two sticks (D+S devices only)
799 964	Operating stick [fuse tong, insulating stick, switching stick and rescue rod] (all brands)
799 965	Operating stick kit (all brands)
799 966	Additional test prod for voltage detectors and two-pole phase comparators
799 967	Test probe
Periodic Testing (visual and technical) of ...	
799 990	Single-pole earthing and short-circuiting device (Dimension ≤ 8,500 mm)
799 991	Three-pole earthing and short-circuiting device (Dimension ≤ 1,000/1,000/1,000 / 2,500 mm)
Technical Testing of ...	
799 992	Earthing stick (all brands)
799 993	Test adapter / measuring impedance for capacitive voltage detecting system (all brands)
799 994	Earthing and discharge devices

* including one test prod / ** including two test prods

Further Equipment

Product	Type	Application	Page
Measuring Device			
	MikroΩmeter	Mobile measuring system for performing technical tests on portable earthing and short-circuiting devices at regular intervals	148
VLD Voltage Limiting Devices			
	SDS	Voltage limiting devices	149
Barriers			
		Barriers	151
Discharge Devices			
		For discharging static charges Different contact electrodes	153
Storage Bags and Transport Cases			
		Easy Choice	158
		Cases: Sheet steel or plastic Bags: Artificial leather or canvas	159
Accessories, Spare Parts and Kit Parts			
		Accessories	163
		Spare parts	168
		Kit parts	169
Index			
		Index of Part Nos.	179
		Index of Variant Nos.	186
		Index of Types	187
		Key words	192

MicroΩmeter LoRe EaS

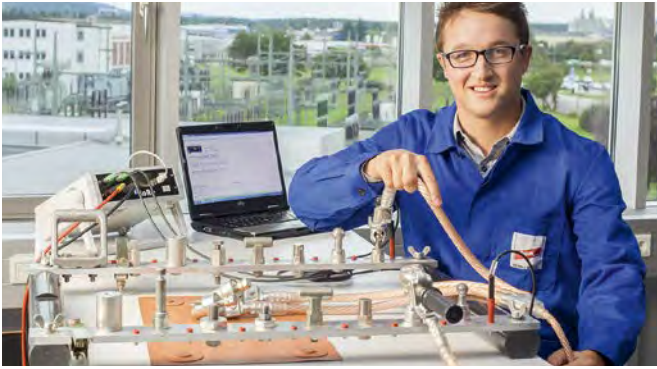

MicroΩmeter LoRe EaS

- Mobile measuring system for performing technical tests on portable earthing and short-circuiting devices (EaS) at regular intervals
- For determining minimum ohmic resistances of earthing and short-circuiting devices and the quality of electrical connections e.g. conductor rails or switch contacts
- Electronic transfer of measured values to the evaluation software via USB interface
- Software-aided procedure and automatic documentation of results
- Acoustic signal as soon as the limit values are exceeded
- Calibrated when delivered
- Software update via USB interface

MikroΩmeter LoRe EaS

Double rail system included in delivery.



Type	MOMS LORE EUK
Part No.	799 100
Measuring range	0.01 μΩ ... 500 mΩ
Min. resolution	1 nΩ
Measuring accuracy	10 nΩ
Type of measurement	Four-conductor measurement
Measuring current	Approx. 30 A ... 70 A
Interface	USB 2.0 connection
Dimensions (case) (H x W x D)	190 x 500 x 450 mm
Weight (with accessories)	Approx. 9 kg
Temperature range	-10 °C ... +40 °C



Voltage Limiting Devices

- Electrical isolation of insulated track sections and earthed parts of installations
- Safe equipotential bonding in case of a short-circuit or earth fault at the overhead contact line due to high-current-resistant welding of the electrodes
- Discharge of lightning surges without short-circuit formation due to lightning-resistant SDS ... voltage limiting device
- Short-circuit withstand capability up to 25 kA_{rms} / 100 ms; 36 kA_{rms} / 75 ms



EN 50122-1 describes the use of voltage limiting devices for d.c. and a.c. traction systems for so-called „open traction system earthing“ of conductive components of the overhead contact line and pantograph zone. Voltage limiting devices (SDS ...) are used to prevent the occurrence of hazardous surges between the insulated tracks or track sections of electric railways and earthed parts of the installation.

Their function is to permanently connect parts of the installation in the overhead contact line and pantograph zone to the return circuit as soon as the threshold voltage is exceeded.

In case of atmospheric overvoltages, the lightning-resistant SDS ... voltage limiting device is capable of returning to its initial state after discharging the impulse current. Only if the specified lightning current load is exceeded, a permanent short-circuit is initiated by high-current-resistant welding of the electrodes and the fuse link has to be replaced.

The SDS voltage limiting device consists of a spark gap unit and the respective connecting kit and can be directly connected to the rail or overhead contact line tower.

The spark gap unit of type SDS 1 (Part No. 923 110) developed by DEHN has also been approved by the German Federal Railway Authority (EBA).

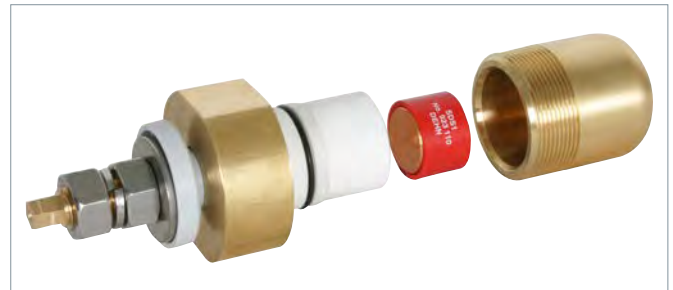

SDS 1 Voltage limiting device for a power-frequency sparkover voltage ≤ 940 V.

Type SDS ...	1
Part No.	923 110
VLD type (EN 50122-1)	VLD-F
Power frequency sparkover voltage (U _{av})	≤ 940 V
d.c. sparkover voltage (U _{ag})	600 V +/- 20 %
Impulse sparkover voltage	≤ 1400 V (1kV/μs)
Self-extinguishing capability	300 A / 65 V
Lightning current discharge capacity (10/350 μs) 0.1x / 0.5x / 1x	5 kA
Lightning current withstand capability (10/350 μs)	25 kA
Safe short-circuit due to welding of the electrodes in case of alternating currents	≥ 2.5 kA / 1000 V / 30 ms, ≥ 1.5 kA / 1000 V / 100 ms
Safe short-circuit due to welding of the electrodes in case of direct currents	≥ 750 A / 250 ms
Short-circuit withstand capability	25 kA _{rms} / 100 ms; 36 kA _{rms} / 75 ms
Long-term current	1 kA _{rms} for t ≤ 120 s
Leakage current (I _{lc})	< 1 μA for 100 V d.c.
Operating temperature range (T _U)	-40 °C ... +80 °C
To be mounted with	mast adapter MA SDS M12 or SIEMENS No. 8WL6503-xx
Approvals	EBA
DB drawing No.	4 Ebs 15.13.20 Sheet 2



SDS 2 Voltage limiting device for a d.c. sparkover voltage of 350 V.

Type SDS ...	2
Part No.	923 117
VLD type (EN 50122-1)	VLD-F
d.c. sparkover voltage (U _{ag})	350 V +/- 20 %
Impulse sparkover voltage	≤ 900 V (1 kV/μs)
Lightning current discharge capacity (10/350 μs) 0.1x / 0.5x / 1x	2 kA
Lightning current withstand capability (10/350 μs)	25 kA
Safe short-circuit due to welding of the electrodes in case of direct currents	≥ 600 A / 250 ms
Short-circuit withstand capability	25 kA _{rms} / 100 ms; 36 kA _{rms} / 75 ms
Long-term current	1 kA _{rms} for t ≤ 120 s
Leakage current (I _{lc})	< 1 μA for 100 V d.c.
Operating temperature range (T _U)	-40 °C ... +80 °C
To be mounted with	mast adapter MA SDS M12 or SIEMENS No. 8WL6503-xx



SDS 3

Voltage limiting device for a d.c. sparkover voltage of 550 V.



Type SDS ...	3
Part No.	923 116
VLD type (EN 50122-1)	VLD-F
d.c. sparkover voltage (U_{ag})	550 V +/- 20 %
Impulse sparkover voltage	≤ 1000 V (1 kV/μs)
Lightning current discharge capacity (10/350 μs) 0.1x / 0.5x / 1x	2.5 kA
Lightning current withstand capability (10/350 μs)	25 kA
Short-circuit withstand capability	25 kA _{rms} / 100 ms
Operating temperature range (T_U)	-40 °C ... +80 °C
To be mounted with	mast adapter MA SDS M12 or SIEMENS Nr. 8WL6503-xx

SDS 4

Voltage limiting device for a d.c. sparkover voltage of 230 V.



Type SDS ...	4
Part No.	923 118
VLD type (EN 50122-1)	VLD-F
d.c. sparkover voltage (U_{ag})	230 V +/- 20%
Impulse sparkover voltage	≤ 650 V (1 kV/μs)
Lightning current discharge capacity (10/350 μs) 0.1x / 0.5x / 1x	2.5 kA
Lightning current withstand capability (10/350 μs)	25 kA
Impulse current discharge capacity (8/20 μs) 0.1x / 0.5x / 1x	20 kA
Safe short-circuit due to welding of the electrodes in case of direct currents	≥ 600 A / 250 ms
Short-circuit withstand capability	25 kA _{rms} / 100 ms; 36 kA _{rms} / 75 ms
Long-term current	1 kA _{rms} for t ≤ 120 s
Leakage current (I_{lc})	< 1 μA for 100 V d.c.
Operating temperature range (T_U)	-40 °C ... +80 °C
To be mounted with	mast adapter MA SDS M12 or SIEMENS No. 8WL6503-xx

SDS 5

Voltage limiting device for a d.c. sparkover voltage of 120 V.



Type SDS ...	5
Part No.	923 119
VLD type (EN 50122-1)	VLD-F
d.c. sparkover voltage (U_{ag})	120 V +/- 20 %
Impulse sparkover voltage	≤ 600 V (1 kV/μs)
Lightning current discharge capacity (10/350 μs) 0.1x / 0.5x / 1x	2 kA
Lightning current withstand capability (10/350 μs)	25 kA
Impulse current discharge capacity (8/20 μs) 0.1x / 0.5x / 1x	20 kA
Safe short-circuit due to welding of the electrodes in case of direct currents	≥ 600 A / 250 ms
Short-circuit withstand capability	25 kA _{rms} / 100 ms; 36 kA _{rms} / 75 ms
Long-term current	1 kA _{rms} for t ≤ 120 s
Leakage current (I_{lc})	< 1 μA for 100 V d.c.
Operating temperature range (T_U)	-40 °C ... +80 °C
To be mounted with	mast adapter MA SDS M12 or SIEMENS No. 8WL6503-xx

Accessories for Voltage Limiting Devices

Mast adapter for SDS Voltage Limiting Devices

For installation on the mast profile of overhead contact line masts with Ø8-12 mm.



Type	MA SDS M12
Part No.	723 199
Lightning current carrying capability (10/350 μs)	25 kA
Short-circuit withstand capability	21 kA _{rms} / 30 ms
Long-term current	1 kA _{rms} at t ≤ 120 s
Leakage current (I_{lc})	< 1 μA at 100 V d.c.
Dimensions of the threaded pin	M12
Material	Ms
Degree of protection of the inner enclosure	IP 67

Barrier and Accessories

Barrier and accessories for providing protection for installation parts.



Barrier in a transformer station.

Barrier

Robust design, suitable for indoor and outdoor installations.

Type	AB 32 46 RW K L...
Part No.	700 099
Material	Glass-fibre reinforced polyester
Dimensions (W x H)	32 x 46 mm
Length	Any up to 6000 mm *)
Colour	Red ● / White ○



*) Length to be specified when ordering!

Barrier Holder

1 set = 2 pieces

Type	H AB 32 46 K
Part No.	700 098
Material	Plastic
Colour	Red ●





DEHN protects.®

Discharge and Equipotential Bonding Devices

- For discharging static charges
- Different contact electrodes
- Coupling electrode, especially for round conductors (Ø12 ... 26.5 mm) of electrostatic precipitator systems
- Waterproof, plastic-sheathed cable entries, with additional anti-kink protection



Single-pole device for discharging static charges



General Information:

Not for use in wet weather conditions	
Material (contact electrode)	Cu alloy/gal Sn
Material (contact and coupling electrode)	Zamak
Material (coupling electrode)	Bronze/gal Sn
Material (insulating tube)	Glass-fibre reinforced polyester tube
Material (earthing cable)	Cu, highly flexible

Discharge Device with Handle and Earth Clamp with Wing Bolt

Type	EV TES 465 EK
Part No.	758 020
Cable length	3500 mm
Cable cross-section	16 mm ²
Cable sheath	Transparent
Total length (l _G)	550 mm
Clamping range	Up to 20 mm

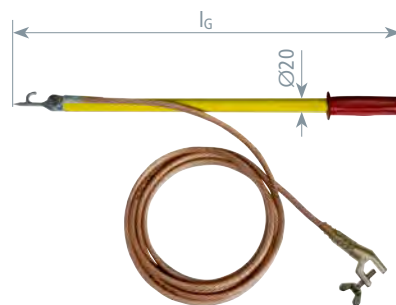

Discharge Device with Handle and Spring-loaded Earth Pliers

Type	EV TES 465 EZ
Part No.	758 021
Cable length	3500 mm
Cable cross-section	16 mm ²
Cable sheath	Transparent
Total length (l _G)	550 mm
Clamping range	Up to 18 mm

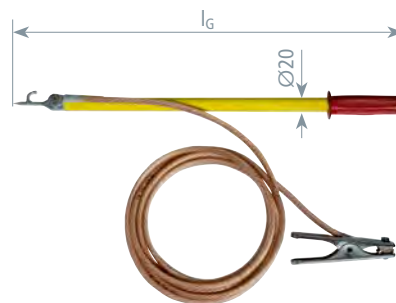

Discharge Device with Handle and Cable Lug at the Earth Cable End

Hole (Ø8.4 mm) and silicone cable

Type	EV TES 465 KS10
Part No.	758 022
Cable length	3500 mm
Cable cross-section	10 mm ²
Cable sheath	Red silicone cable
Total length (l _G)	550 mm

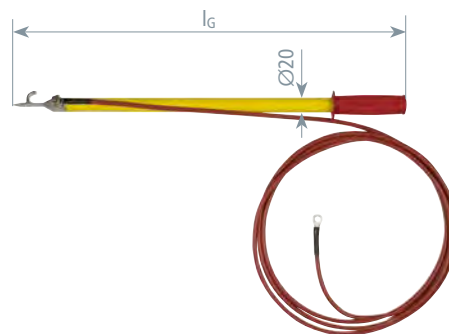

Discharge Device with Earth Clamp with Wing Bolt

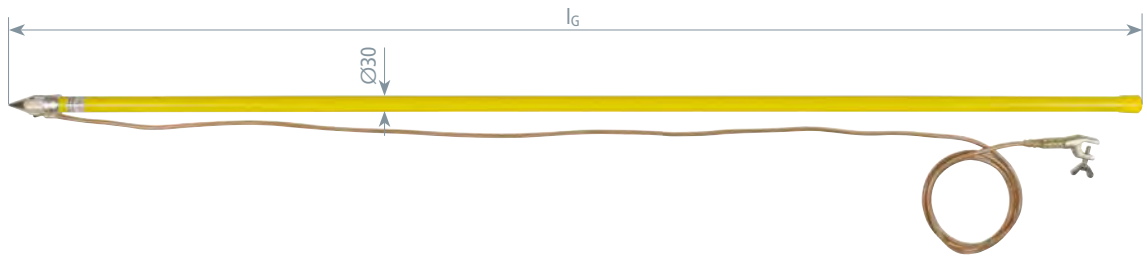

Type	EV TS 2000 EK
Part No.	758 001
Cable length	3500 mm
Cable cross-section	16 mm ²
Cable sheath	Transparent
Total length (l _G)	2050 mm
Clamping range	Up to 20 mm

Discharge Device with Spring-loaded Earth Pliers

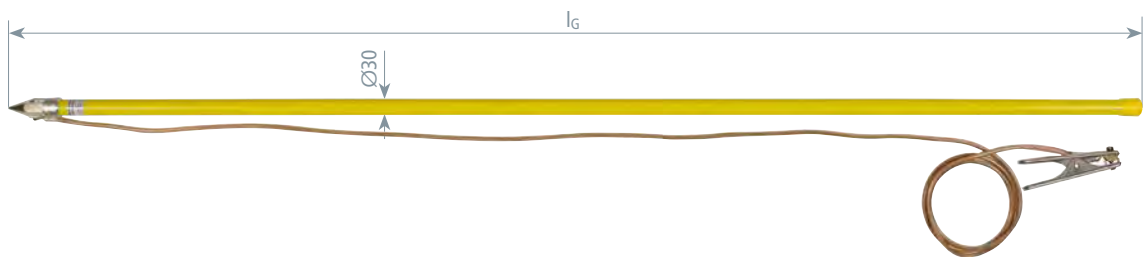

Type	EV TS 2000 EZ
Part No.	758 003
Cable length	3500 mm
Cable cross-section	16 mm ²
Cable sheath	Transparent
Total length (l _G)	2050 mm
Clamping range	Up to 18 mm

*) Check according to own data

Earthing Device with Earth Clamp with Tommy Bar

For round conductors (Ø12 ... 26.5 mm) of electrostatic precipitator systems

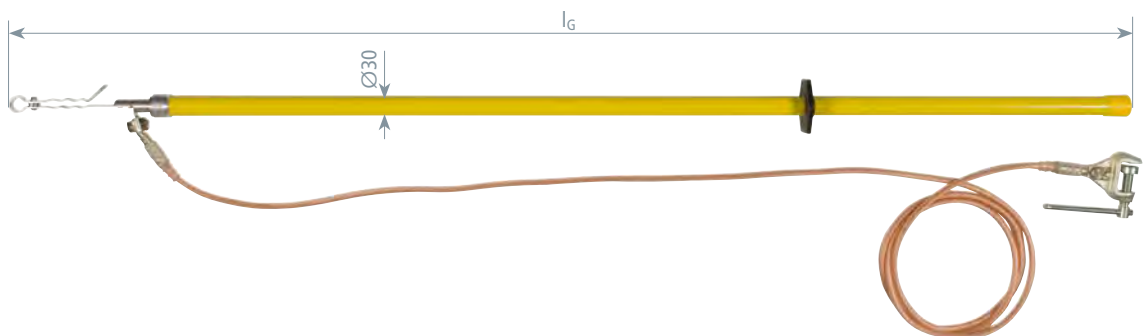

Type	EV EH 1725 EK
Part No.	758 015
Cable length	3500 mm
Cable cross-section	25 mm ²
Cable sheath	Transparent
Total length (l _G)	1725 mm
Clamping range	Up to 30 mm

Discharge Device with Contact and Coupling Electrode and Cable Lug at the Earth Cable End

PK1 anti-rotation crimped cable lug (hole $\varnothing 12.5$ mm).

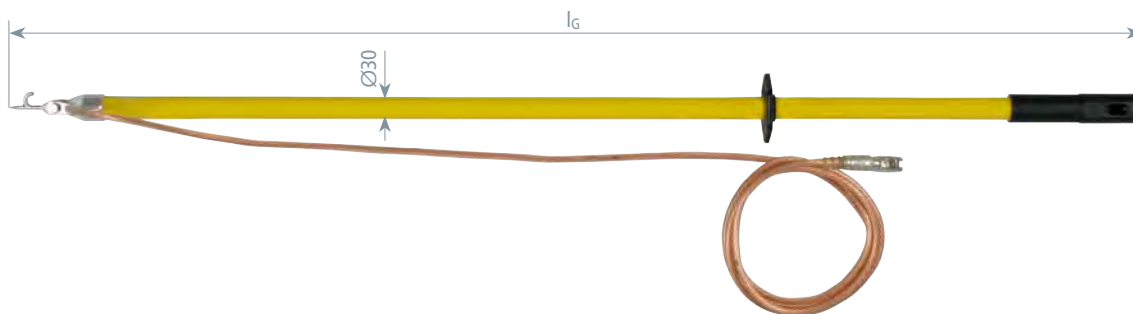

Type	EV TES STK 1500 KS
Part No.	758 025
Cable length	3500 mm
Cable cross-section	16 mm ²
Cable sheath	Transparent
Total length (l_G)	1500 mm

Discharge Device with Contact Electrode and Cable Lug at the Earth Cable End

PK1 anti-rotation crimped cable lug (hole $\varnothing 12.5$ mm).

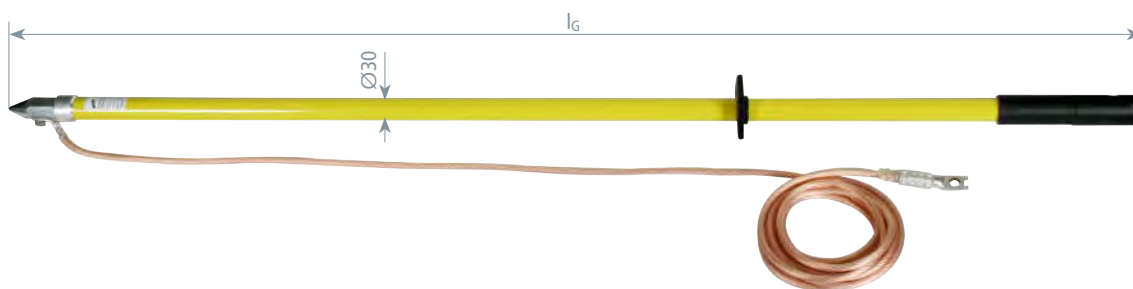

Type	EV TS 1470 SN7685
Part No.	758 031
Cable length	5000 mm
Cable cross-section	16 mm ²
Cable sheath	Transparent
Total length (l_G)	1500 mm

Discharge Device with Clamp and Cable Lug at the Earth Cable End

PK1 anti-rotation crimped cable lug (hole $\varnothing 12.5$ mm).

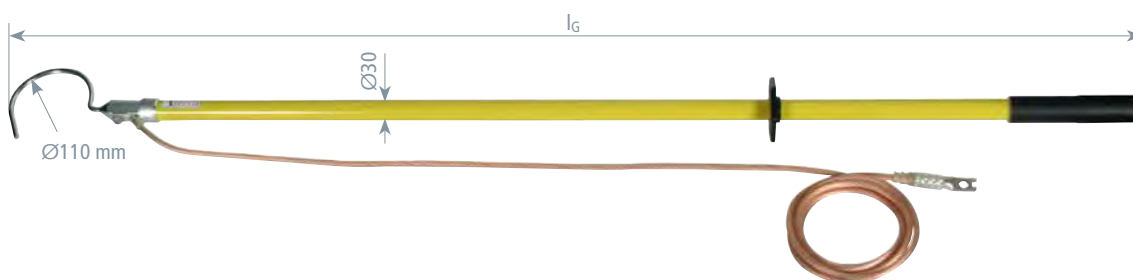

Type	EV EHB 1600 SN7114
Part No.	758 028
Cable length	3500 mm
Cable cross-section	16 mm ²
Cable sheath	Transparent
Total length (l_G)	1600 mm



Equipotential Bonding Device with Insulated Earth Clamps

Type	PAV 3+1 16 ZAK
Part No.	758 099
Cable length (A / B / C)	1750 mm
Cable length (D)	3200 mm
Cable cross-section	16 mm ²
Cable sheath	transparent
Clamping range	5-25 mm

Single Parts for Discharge Devices

Discharge Device with Handle, without Earth Cable

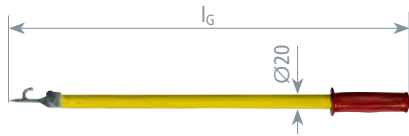

Type	EV TES 465 SN7215
Part No.	758 036
Total length (l _G)	550 mm
Screw	M8 x 20 mm

Discharge Device with Contact Electrode without Earth Cable

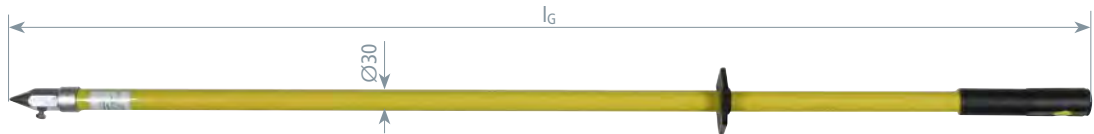

Type	EV TS STK 1470
Part No.	758 075
Total length (l _G)	1470 mm
Screw	M8 x 20 mm

Discharge Device with Contact and Coupling Electrode without Earth Cable

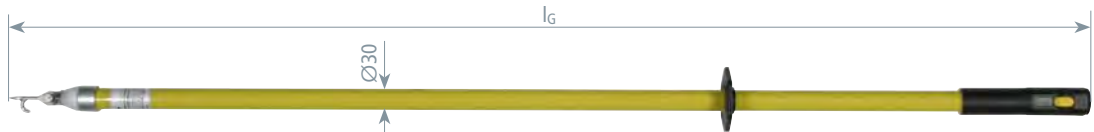

Type	EV TES STK 1500
Part No.	758 085
Total length (l _G)	1500 mm
Screw	M8 x 20 mm

Discharge Device with Hook without Earth Cable

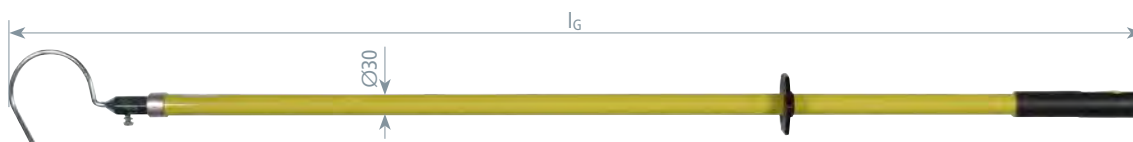

Type	EV EHB STK 1600
Part No.	758 095
Total length (l _G)	1600 mm
Screw	M8 x 20 mm

Earth cable with crimped cable lug

Earthing cable combinable with discharge device.

PK1 crimped cable lug for connection with earth connecting elements.



Type	EL 16CU KS12.5 8.5	EL 25CU KS12.5 8.5	EL 35CU KS12.5 8.5
Part No.	758 116	758 125	758 135
Material	Cu	Cu	Cu
Type of crimped cable lug	PK1 (Ø12.5 mm) and PK2 (Ø8.5 mm)	PK1 (Ø12.5 mm) and PK2 (Ø8.5 mm)	PK1 (Ø12.5 mm) and PK2 (Ø8.5 mm)
Cable cross-section	16 mm ²	25 mm ²	35 mm ²
Cable length	To be specified on order (500-25000 mm)	To be specified on order (500-25000 mm)	To be specified on order (500-25000 mm)

Earthing cable length to be specified when ordering (in steps of 500 mm).

Earth cable with earth pliers

Earth cable combinable with discharge device.



Type	EL 16CU EZ KS8.5
Part No.	758 216
Material (cable)	Cu
Type of crimped cable lug	PK2 (Ø8.5 mm)
Material of pliers	StSt
Clamping range Rd / Fl	Up to Ø16 mm / up to 13 mm
Cable cross-section	16 mm ²
Cable length	To be specified on order (500-25000 mm)

Earthing cable length to be specified when ordering (in steps of 500 mm).

Easy Choice

Storage Bags and Transport Cases Safety Equipment	Sheet Steel Case					Plastic Case										Artificial Leather Bag						Storage Bag								
	767 701	759 003	745 900	766 300	766 298	767 997	767 999	766 036	766 998	766 995	766 994	767 107	745 953	745 952	745 902	745 106	767 996	766 602	766 996	767 574	767 500	766 614	766 543	766 601	766 704	766 039	769 509	785 111	785 442	785 443
PHE4 up to l _G 1450 mm																														
PHE4 up to l _G 3420 mm * up to l _G 1760 mm																									*					
PHE4 from l _G 4420 mm (l _G 5750 mm)																														
PHE III up to l _G 1675 mm																														
PHE III ZK Indicator with Test Prod																														
PHE III – Set * up to 1270 mm								*																						
PHE – Set DB for Part No. 766 616																														
ASP * for Part No. 767 573																	*													
HSA																														
PHE/G																														
Voltage Detectors for LV Installations																														
PHV I up to l _G 1270 mm																														
PHV I up to l _G 1730 mm																														
DEHNcap																														
Earthing and Short-Circuiting Device																														
EaS Kit for LV Installations																														
EaS Kit Street Lighting																														
Insulating Stick																														
Insulating Stick Kit																														
Earthing Stick																														
DEHNcare® ESH, APS and APG																														
DEHNcare® for complete protective equipment																														

Note: All storage bags and transport cases are delivered without content.

Storage Bags and Transport Cases

Sheet Steel Case

- For voltage detectors and earthing and short-circuiting devices VI/TI.

Sheet Steel Case for PHE III

Hammer-tone finished with foam padding.

Type	SKL 95 21 10
Part No.	767 701
Dimensions	950 x 210 x 115 mm
Colour	Blue ●



Sheet Steel Case for Earthing and Short-Circuiting Device VI/TI

Optionally available with foam padding

Type	SBKL EKS VI KVS	SBKL EKS TI KVS 2F	SBKL EKS TI KVS
Part No.	745 900	766 298	766 300
Dimensions	440 x 330 x 100 mm	440 x 330 x 66 mm	380 x 260 x 80 mm
Colour	Blue ●	Blue ●	Blue ●
Design	With foam padding	With foam padding	—



Plastic Case

- For voltage detectors, phase comparators, voltage detecting systems and earthing and short-circuiting devices.

Universal Plastic Case for PHE4, PHE III and PHV I

With aluminium frame and convoluted foam.

Type	KKL 92 28 12	KKL 127 28 12
Part No.	766 994	766 995
Dimensions	920 x 280 x 126 mm	1270 x 280 x 126 mm
Colour	Black ●	Black ●



Plastic Case for PHE III

With foam padding

Type	KKL PHE3	KKL PHE3 L
Part No.	767 997	767 999
Dimensions	940 x 235 x 140 mm	1290 x 235 x 140 mm
Colour	Black ●	Black ●



Plastic Case for PHE III Indicator with Test Prod

With foam padding

Type	KKL PK PHE3 L
Part No.	766 036
Dimensions	390 x 280 x 80 mm
Colour	Grey ●



Plastic Case for PHE III – Kit

With foam padding

Type	KKL PHE3 60 110
Part No.	766 998
Dimensions	1290 x 235 x 140 mm
Colour	Black ●



Storage Bags and Transport Cases



Plastic Case for DEHNcap

With foam padding

Type	KKL DCA
Part No.	767 107
Dimensions	390 x 280 x 84 mm
Colour	Grey ●



Plastic Case for Earthing and Short-Circuiting Device VI/TI

With foam padding

Type	KK 56 41 17 EK VI TI	KKL EKS VI KVS
Part No.	745 952	745 902
Dimensions	565 x 410 x 170 mm	450 x 350 x 110 mm
Colour	Black ●	Black ●



Plastic Case for Earthing and Short-Circuiting Devices

With retaining springs for two-part earthing stick.

Type	KK 56 41 17 EK HK
Part No.	745 953
Dimensions	565 x 410 x 170 mm
Colour	Black ●



Artificial Leather Bag

- For voltage detectors, phase comparators and insulating sticks.

Artificial Leather Bag for PHE4, PHE III, ASP, PHV I and IS STK

With zip, carrier handle and shoulder strap.



Type KLT ...	101 30 10	133 34 10
Part No.	767 996	766 996
Dimensions	1010 x 300 x 100 mm	1300 x 345 x 100 mm
Colour	Black ●	Black ●

Artificial Leather Bag for PHE4 and PHE

With carrier handle



Type KLT ...	247 10 22
Part No.	766 602
Dimensions	2470 x 220 x 100 mm
Colour	Black ●

Artificial Leather Bag for PHE4, PHE and PHV I

With carrier handle



Type KLT ...	121 25 16
Part No.	766 601
Dimensions	1200 x 250 x 160 mm
Colour	Black ●

Storage Bags and Transport Cases

Artificial Leather Bag for PHE/G

With carrier handle

Type KLT ...	160 17
Part No.	766 614
Dimensions	Ø170 x 1600 mm
Colour	Black ●



Artificial Leather Bag for ASP and HSA

With carrier handle.

Type KLT ...	104 9
Part No.	767 574
Dimensions	Ø90 x 1040 mm
Colour	Black ●



Canvas Bag

- For voltage detectors, insulating sticks, earthing sticks and earthing and short-circuiting devices.

Canvas Bag for PHE and PHE/G I

With carrier handle.

Type STT ...	120 30 15
Part No.	766 704
Dimensions	1220 x 390 x 150 mm
Colour	Olive ●



Canvas Bag for ISMTC

With carrier handle.

Type STT ...	180 20
Part No.	766 039
Dimensions	Ø200 x 1800 mm
Colour	Olive ●



Canvas Bag for six-part Earthing Stick

With carrier handle.

Type STT ...	110 15
Part No.	769 509
Dimensions	Ø150 x 1100 mm
Colour	Olive ●
DB drawing No.	3 Ebgw 01.67



Canvas Bag for Earthing and Short-Circuiting Device

With two separate internal pockets and carrier handle.

Type STT ...	55 27 30
Part No.	785 111
Dimensions	550 x 255 x 300 mm
Colour	Olive ●
DB drawing No.	3 Ebgw 01.67



Plastic Bag / Rucksack

- For DEHNcare protective equipment.

**Storage Bag**

With side handle, carrying strap and string.

Type	AT 50 30
Part No.	785 442
Suitable for	ESH U + DEHNcare APS and APG
Dimensions	Ø300, 500 mm
Colour	Red ●

**Storage Rucksack**

With carrying straps and side net pocket with string.







Type	ARS 65 40
Part No.	785 443
Suitable for	DEHNcare protective equipment
Dimensions	650 x 400 mm
Colour	Red ●

**Microfibre Bag**

For cleaning and keeping of face shields DEHNcare APS.

Type	MFB APS
Part No.	785 724
Suitable for	DEHNcare APS
Dimensions	450 x 400 mm
Colour	Black ●

Accessories, Spare Parts, Kit Parts

Product	Application	Page
Accessories – Electrodes, Probes		
	Electrodes with M8 thread, to be screwed on test prods	164
	Probes with M8 thread, to be screwed on test electrodes For switchgear installations with limited access	165
Accessories – Adapters and End Fittings		
	With plug-in coupling	166
Accessories – Storage Devices, Installation Devices		
	Storage devices for earthing and short-circuiting devices, sticks and fuse tongs	167
Spare Parts		
		168
Kit Parts – Test Prods, Operating Heads		
	Test prods for safe contact with parts of an installation to be tested	169
	Operating heads	170
Kit Parts – Insulating Sticks, Extensions, Adapters		
	Insulating sticks	172
	Insulating elements	174
	Handle / Extensions	175
	Adapters	177

Electrodes

- Safe contact with the part of an installation to be tested
- With M8 thread, to be screwed on the test prods of PHE4, PHE III, PHE voltage detectors as well as PHV I phase comparators

Onion-shaped Electrode

For contacting varnished busbars.



Type EL M8 ...	SZ PHE PHV
Part No.	766 913
Nominal voltage (U _N)	From 3 kV
Material	Brass/gal CuSn

Pin-shaped Electrode

For contacting varnished busbars.



Type EL M8 ...	S PHE PHV
Part No.	766 925
Nominal voltage (U _N)	From 3 kV
Material	StSt

V-shaped Electrode

For contacting round conductors.



Type EL M8 ...	V PHE PHV
Part No.	766 927
Nominal voltage (U _N)	From 3 kV
Material	Cu/gal Sn

Hook-shaped Electrode

For contacting overhead line conductors.



Type EL M8 ...	H PHE
Part No.	766 923
Application	For overhead lines only
Material	St/gal Zn

Fork-shaped Electrode

For contacting overhead line conductors.



Type EL M8 ...	G PHE
Part No.	766 924
Application	For overhead lines only
Material	StSt

Eaton Holec Magnefix Electrode

For Eaton Holec Magnefix switchgear installations of type MA, MD4, MF, MG, MY.



Type EL M8 ...	MAG PHE PHV
Part No.	766 915
Nominal voltage (U _N)	3 ... 15 kV
Material	Brass/gal CuSn, PVC

Test Probes

- Safe contact with the part of an installation to be tested
- With M8 thread, to be screwed on test electrodes of PHE4, PHE III and PHE voltage detectors
- For switchgear installations with limited access
- Available in different lengths and angles

Test Probe, straight

For switchgear installations with limited access
(e.g. Calor Emag/Isopond and Krone/KES)

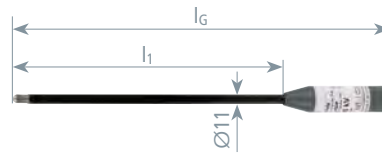

Type PSO M8 ...	PHE
Part No.	766 916
Nominal voltage (U _N)	3 ... 24 kV
Total length (l _G)	420 mm
Length (l ₁)	300 mm
Diameter	11 mm
For use at	



Test Probe, straight, 800 mm

For transformer stations and switchgear installations that require a greater insertion depth.



Type PSO M8 ...	PHE L800
Part No.	766 960
Nominal voltage (U _N)	3 ... 24 kV
Total length (l _G)	890 mm
Diameter	14 mm
For use at	



Test Probe, 25° angled

For switchgear installations with limited access.

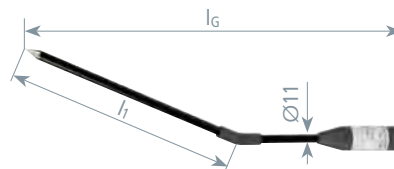

Type PSO M8 ...	W25 PHE
Part No.	766 940
Nominal voltage (U _N)	3 ... 24 kV
Total length (l _G)	450 mm
Length (l ₁)	280 mm
Diameter	11 mm
For use at	



Test Probe, 45° angled

For switchgear installations with limited access.

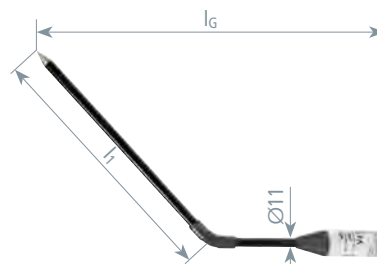

Type PSO M8 ...	W45 PHE
Part No.	766 941
Nominal voltage (U _N)	3 ... 24 kV
Total length (l _G)	395 mm
Length (l ₁)	280 mm
Diameter	11 mm
For use at	



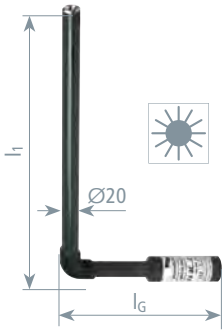

Test Probe, 90° angled

For switchgear installations with a limited tulip-shaped access from bottom to top.

Type PSO M8 ...	W90 PHE
Part No.	766 950
Nominal voltage (U _N)	3 ... 36 kV
Total length (l _G)	200 mm
Length (l ₁)	370 mm
Diameter	20 mm
For use at	☀

Test probes for other special switchgear installations are available on request.

Adapters and End Fittings



Adapter (Plug-In Coupling / T Pin Shaft)

For extending the handle of IS ... STK insulating sticks by an ES SQ or ES SQL earthing stick.

Type	AD HV STK SQ
Part No.	766 313
Total length (l _G)	275 mm



End Fitting STK (Plug-in Coupling)

For use as termination and protection

Type	A STK
Part No.	766 888
Total length (l _G)	85 mm
Diameter	30 / 43 mm



End Fitting STK with Eye

For use as protection and transport eye when working on overhead lines.

Type	AR STK
Part No.	766 889
Total length (l _G)	150 mm
Diameter	30 / 43 mm

Storage Devices

- Wall-mounted
- Easy and safe storage of earthing and short-circuiting devices, voltage detectors and operating sticks (Ø30 or 43 mm)

For a Voltage Detector and an Earthing Stick

For a voltage detector and an earthing stick of any length
Hole spacing: 290/390 mm, holes: Ø7 mm

Type HV ...	P ST D24	P ST D30	P ST D40 45
Part No.	700 006	700 007	700 008
Dimensions	530 x 30 x 136 mm	430 x 30 x 136 mm	530 x 30 x 149 mm
For stick diameters	24 mm	30 mm	40 ... 45 mm
DB material No.	—	828 077	—



For an Earthing and Short-Circuiting Device and an Earthing Stick

For an earthing and short-circuiting device and an earthing stick of any length
Hole spacing: 424 mm, holes: Ø7 mm

Type HV ...	EKV ES30	EKV ES40
Part No.	700 000	700 002
Dimensions	525 x 175 x 214 mm	525 x 175 x 214 mm
For stick diameters	30 mm	43 mm
DB drawing No.	3 Ebgw 01.70	—
DB material No.	742 395	—



For an Earthing and Short-Circuiting Device and an Earthing Stick up to 1.5 m

For an earthing and short-circuiting device and an earthing stick with a length up to 1.5 m
Hole spacing: 104 mm, holes: Ø7 mm

Type HV ...	EKV ES30 1500
Part No.	700 003
Dimensions	214 x 150 mm
For stick diameters	30 / 43 mm



For HH Fuses and a Fuse Tong – Single Parts

Wall-mounted, holes Ø7 mm

Type HV ...	3HH ET	3HH SZ ET
Part No.	700 005	700 004
For	HH fuses	HH fuses and a fuse tong

Note: Two storage devices are required!



For HH Fuses and a Fuse Tong – Kit

Wall-mounted, holes Ø7 mm

Kit includes:			
Kit Type	Kit Part No.	consisting of:	Pos. No.
HV 3HH	700 015	2x 700 005	1
HV 3HH SZ	700 014	1x 700 005	1
		1x 700 004	2

Type HV ...	3HH	3HH SZ
Part No.	700 015	700 014
For	3 HH fuses	3 HH fuses and a fuse tong





Electric Bulb

Type	GL 3.5V 0.2A E10
Part No.	766 605
Description	Small electric bulb 3.5 V / 0.2 A
Suitable for	PHE



Mignon Battery

Dangerous goods transport regulations only allow delivery of Part No. 766 611 within Germany.

Type	MZ 1.5V L91 FR6 LI 4	MZ 1.5 IEC LR6 AL
Part No.	766 611	766 618
Description	Mignon battery 1.5 V, lithium	Mignon battery 1.5 V, alkaline manganese
PU	4 pieces	1 piece



Block Battery

Dangerous goods transport regulations only allow delivery of Part No. 767 712 within Germany.

Type	EB 9V LI	EB 9V AL
Part No.	767 712	767 713
Description	9 V E block battery, lithium	9 V E block battery, alkaline manganese
PU	1 piece	1 piece



Protective Rubber for PHE

Type	FSG PHE
Part No.	767 776
Suitable for	PHE

Protective Rubber for PHG II

Type	FSG PHG2 PHV
Part No.	767 777
Suitable for	PHG II and PHV



Sealing Ring for PHE III

Type	DR PS PHE3
Part No.	767 779
Suitable for	PHE III test prod and ASP electric field sensor

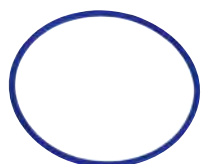

Sealing Ring for PHE4 and PHV I

Type	DR PAG
Part No.	759 798
Suitable for	PHE4 and PHV I



Threaded ring for PHE4 and PHV I

Type	GR PAG
Part No.	759 799
Suitable for	PHE4 and PHV I



Plastic Star Grip Screw

Type	KS SG BLS 8
Part No.	766 105
Total length (l _G)	42 mm
Suitable for	Universal gear coupling

Support

Type	AH ISMTC
Part No.	766 038
Suitable for	Telescopic insulating stick

- Test prod with integrated test electrode allows safe contact with the part of an installation to be tested



General Information:	
Colour	Grey ● or yellow ●
Diameter	20 mm
Material (test electrode)	Cu alloy/gal Sn
Material (test prod)	Glass-fibre reinforced epoxy resin tube

For PHE III up to 30 kV / Category „S“

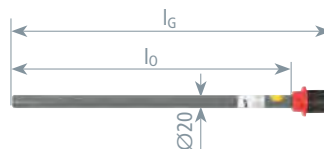

Type	S60 PS PHE 285	S61 PS PHE 435	S62 PS PHE 620	S63 PS PHE 780	S64 PS PHE 880
Part No.	767 760	767 761	767 762	767 763	767 764
Total length (l _G)	320 mm	470 mm	655 mm	815 mm	915 mm
Insertion depth (l _o)	285 mm	435 mm	620 mm	780 mm	880 mm

For PHE III above 30 kV / Category „S“

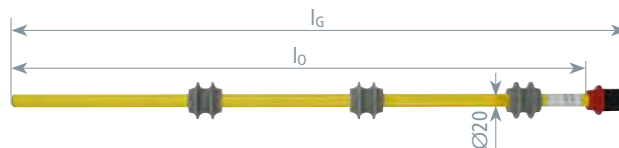

Type	S66 PS PHE 880	S66PS PHE880 C SN7771
Part No.	767 771	769 701
Total length (l _G)	915 mm	915 mm
Insertion depth (l _o)	880 mm	880 mm
Type	–	Coded

For PHE III up to 30 kV / Category „L“

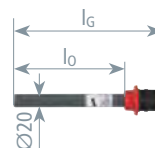

Type	L71 PS PHE 185
Part No.	767 766
Total length (l _G)	220 mm
Insertion depth (l _o)	185 mm

For Siemens 8CK Switchgear Installations

Category „S“ for voltage detector PHE III Part No. 767 721, 767 951, 767 722, 767 740 and 767 940.

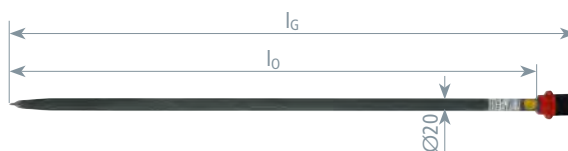

Type	S63 PS PHE 8CK
Part No.	767 768
Total length (l _G)	880 mm
Insertion depth (l _o)	845 mm

For Mipak Switchgear Installations

Category „S“ for voltage detectors (and indicators) PHE III Part Nos. 767 731 (767 796), 767 750 (767 728), 767 961 (767 956) and 767 950 (767 968).

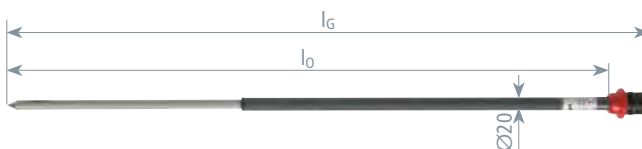

Type	S65 M PS PHE 905
Part No.	767 767
Total length (l _G)	940 mm
Insertion depth (l _o)	905 mm

For PHE 15 kV / 16.7 Hz

Test prod suitable for indicator with test prod Part No. 766 677.



Type	PS PHE 15 16.7
Part No.	766 619
Total length (l _G)	1060 mm

Other versions are available on request.

Operating Heads

STK Switching stick head

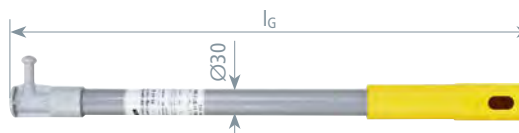

Type	SSK 36 STK 560	SSK 36 STK 930SN7689
Part No.	766 164	766 169
Total length (l _G)	560 mm	930 mm

STK Operating head / T pin shaft

Operating head with spring-loaded bayonet coupling for indoor use.

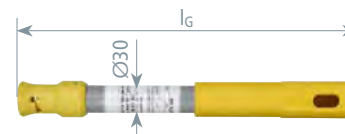

Type	AK 36 SQ STK 360
Part No.	766 365
Total length (l _G)	360 mm

STK Operating head / hexagon shaft

Operating head with tension spring locking and M12 threaded bushing for indoor use.

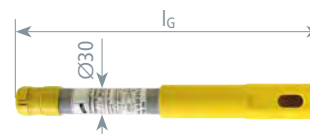

Type	AK 36 SK STK 330
Part No.	766 364
Total length (l _G)	330 mm

Screw-on switching stick head for IS SK insulating sticks

With M12 thread.
In accordance with DIN VDE V 0681-2.



Type	SSK M12
Part No.	765 005
Material	Steel, plastic-sheathed

Switching stick head for IS SQ insulating sticks

With T pin shaft (bayonet locking mechanism).
In accordance with DIN VDE V 0681-2.
T pin shaft in accordance with DIN 48087.
Switching stick head is fixed on the insulating stick via the knurled nut.



Type	SSK SQ
Part No.	765 009
Material	Polyamide

SQL Operating head



Type	ES SQL STK 43 1045
Part No.	766 074
Total length (l _G)	1045 mm
Diameter	43 mm
DB drawing No.	3 Ebgw 01.68

SQL Operating head with aluminium plug-in coupling

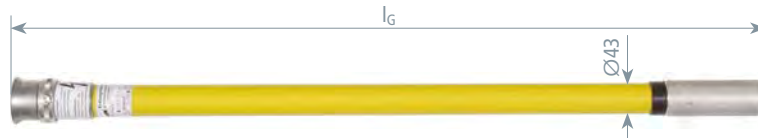

Type	ES SQL ALSTK 1035
Part No.	769 516
Total length (l _G)	1035 mm
Diameter	43 mm

Contacting aid

For telescopic insulating sticks.

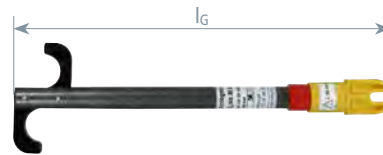

Type	AK AH ZK ISMTC
Part No.	766 049
Total length (l _G)	340 mm

Cleaning head

Flexibly adjustable, for attaching cleaning pads.

Type	RK 230 100 AS25
Part No.	766 056
Dimensions	230 x 100 mm
Diameter	25 mm



Accessories for Cleaning Head

Rectangular cleaning pad

Type	RP 250 115 20
Part No.	766 057
Dimensions	250 x 115 x 20 mm
PU	5 pc(s)



Insulating Sticks

Insulating stick for PHE4 with M12 threaded bushing

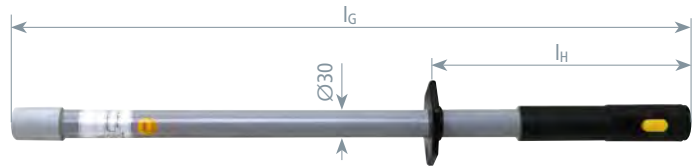

Type	IS PHE4 STK 700	IS PHE4 STK 770	IS PHE4 STK 1110
Part No.	783 900	783 905	783 906
Total length (l _G)	700 mm	770 mm	1110 mm
Length (handle) (l _H)	250 mm	220 mm	520 mm
Diameter	30 mm	30 mm	30 mm
Material	Glass-fibre reinforced polyester tube	Glass-fibre reinforced polyester tube	Glass-fibre reinforced polyester tube

Insulating stick for ASP with universal gear coupling

Plug-in coupling for extending the handle.

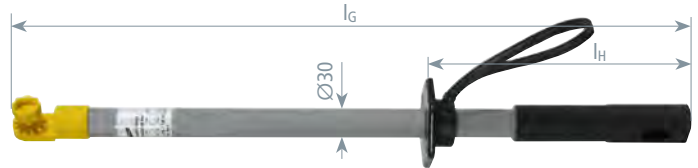

Type	IS ZK STK HS 670
Part No.	766 369
Total length (l _G)	670 mm
Length (handle) (l _H)	270 mm
Diameter	30 mm
Material	Glass-fibre reinforced polyester tube

Insulating stick for PHE III with M12 threaded bushing

With plug-in coupling for extending the handle.

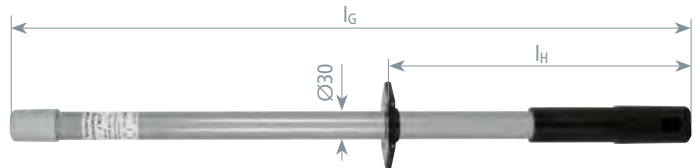

Type	IS M12 STK 640
Part No.	766 331
Total length (l _G)	640 mm
Length (handle) (l _H)	270 mm
Diameter	30 mm
Material	Glass-fibre reinforced polyester tube

Insulating stick for PHE III with M12 threaded bushing

With end cap.

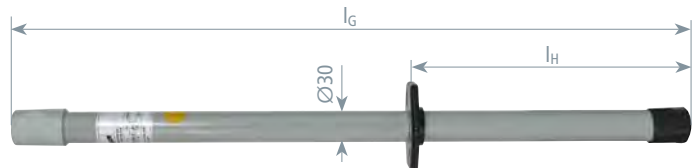

Type	IS M12 AK 635
Part No.	766 328
Total length (l _G)	635 mm
Handle length (l _H)	270 mm
Diameter	30 mm
Material	Glass-fibre reinforced polyester tube

Insulating stick for PHE4 and PHE III with universal gear coupling

Handle end fitting with plastic plug-in coupling as extension handle.

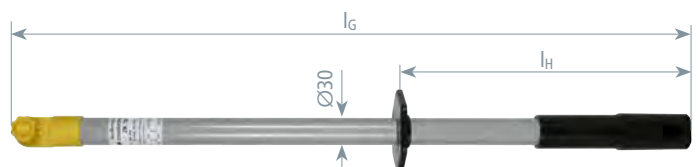

Type	IS ZK STK 670
Part No.	766 368
Total length (l _G)	670 mm
Length (handle) (l _H)	265 mm
Diameter	30 mm
Material	Glass-fibre reinforced polyester tube

Kit Parts

Insulating stick for cleaning windscreens

Consists of one element, with foam-filled insulating element.

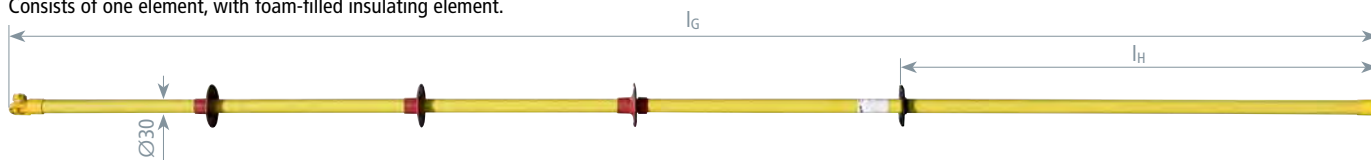

Type	IS 25 ZK 2885
Part No.	766 048
Nominal voltage (U _N)	Up to 25 kV AC
Total length (l _G)	2890 mm
Length (handle) (l _H)	1000 mm
Diameter	30 mm
Material	Glass-fibre reinforced polyester tube

Telescopic insulating stick, with universal gear coupling

With scale for measuring the ground clearance, mounted support included.

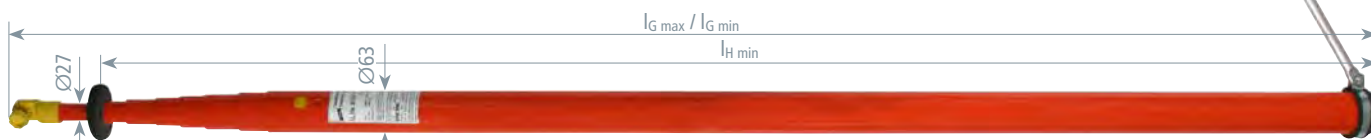

Type	ISMTC N 36 ZK 10600
Part No.	766 037
Nominal voltage (U _N)	Up to 36 kV
Total length (l _{G max} / l _{G min})	10,600 / 1750 mm
Length (handle) (l _{H min})	1680 mm
Material	Glass-fibre reinforced epoxy resin tube

IS STK Insulating stick with plug-in coupling

Plug-in coupling at both ends for attaching extension elements, operating heads or adapters.

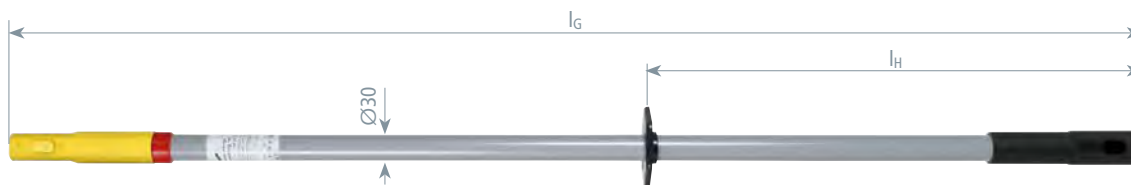

Type	IS 36 STK 30 1280
Part No.	766 363
Nominal voltage (U _N)	Up to 36 kV
Total length (l _G)	1280 mm
Length (handle) (l _H)	560 mm
Diameter	30 mm

ISN 36 STK Insulating stick with silicon insulator

Plug-in coupling at both ends for attaching extension elements, operating heads or adapters.

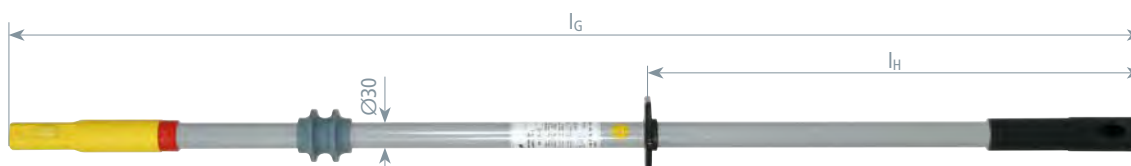

Type	ISN 36 STK 30 1280	ISN 36 STK 930SN7688
Part No.	766 367	766 362
Nominal voltage (U _N)	Up to 36 kV	Up to 36 kV
Total length (l _G)	1280 mm	930 mm
Length (handle) (l _H)	560 mm	190 mm
Diameter	30 mm	30 mm
Material	Glass-fibre reinforced polyester tube	Glass-fibre reinforced polyester tube

**Insulating stick for PHE
(voltage detectors for overhead lines)**

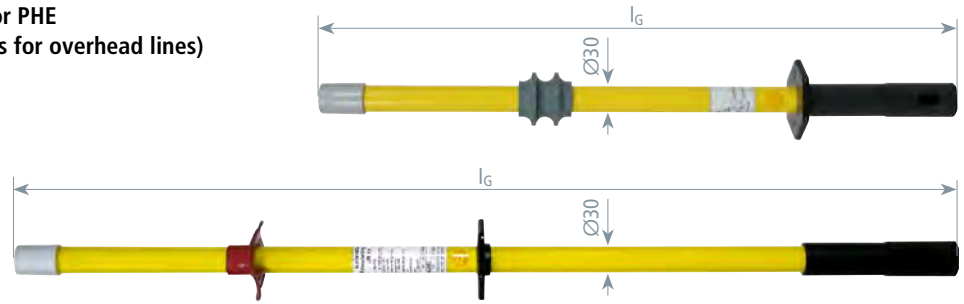

Type	IS M12 STK 30 720	IS M12 STK 30 1060
Part No.	766 072	766 075
Total length (l_G)	720 mm	1060 mm
Diameter	30 mm	30 mm
DB drawing No.	3 Ebgw 02.51	3 Ebgw 02.53

Insulating Elements

Insulating element with M12 threaded bushing

With plug-in coupling for the handle.

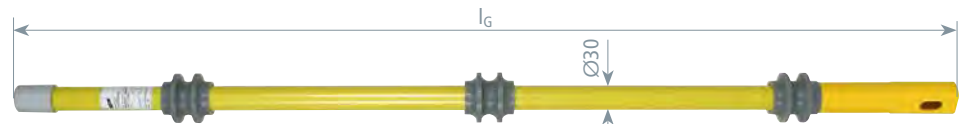

Type	IT M12 STK 30 1150	ISO M12 STK 30SN7563
Part No.	766 115	766 116
Nominal voltage (U_N)	up to 110 kV	up to 110 kV
Total length (l_G)	1150 mm	780 mm
Diameter	30 mm	30 mm
Type	—	coded

**Insulating element
with hand guard**



Type	ISU STK STK 30SN7564
Part No.	766 117
Nominal voltage	up to 110 kV
Total length (l_G)	935 mm
Diameter	30 mm
Type	coded

Insulating element with gear coupling

With plug-in coupling.

Setting angle of the gear coupling: $-30^\circ / 0^\circ / +30^\circ$.

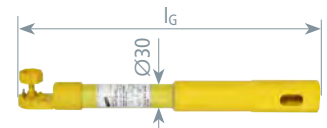

Type	IT ZK30 STK 30 360
Part No.	766 358
Total length (l_G)	360 mm
Diameter	30 mm

**Insulating element
for PHE4**

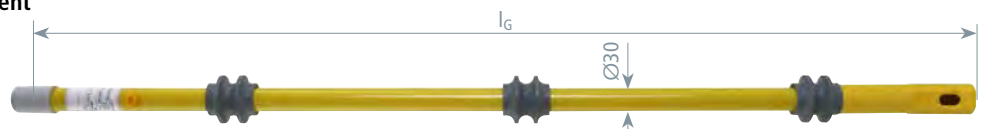

Type	IT PHE4 STK 760	IT PHE4 STK 1210
Part No.	783 920	783 925
Total length (l_G)	760 mm	1210 mm
Diameter	30 mm	30 mm

Handle

With hand guard and end fitting with plug-in coupling for extending the handle.



Type	H STK 43 800		
Part No.	766 120		
Total length (l _G)	830 mm		
Diameter	43 mm		

Handle

With hand guard and end fitting with plug-in coupling for extending the handle.



Type	H STK 43 500		
Part No.	766 520		
Total length (l _G)	500 mm		
Diameter	43 mm		

ISV 36 STK Insulating stick extension

Plug-in coupling at both ends for extending the insertion depth or the handle.

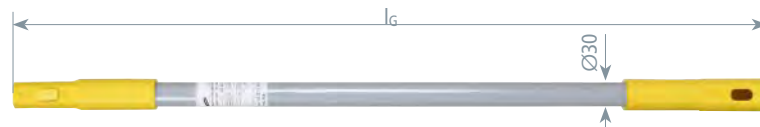

Type	ISV 36 STK 30 910	ISV 36 STK 30 1280
Part No.	766 356	766 366
Total length (l _G)	910 mm	1280 mm
Diameter	30 mm	30 mm

HV STK Extension handle

Plug-in coupling at both ends for extending the handle.

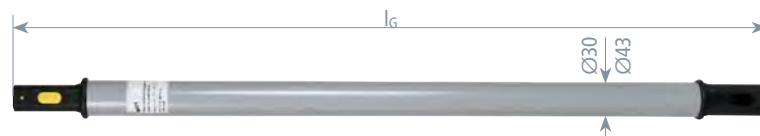

Type	HV STK 30 710	HV STK 43 910	HV STK 43 1280
Part No.	766 335	766 456	766 466
Total length	710 mm	910 mm	1280 mm
Diameter	30 mm	43 mm	43 mm

Extension handle

Plug-in coupling at both ends for extending the handle.

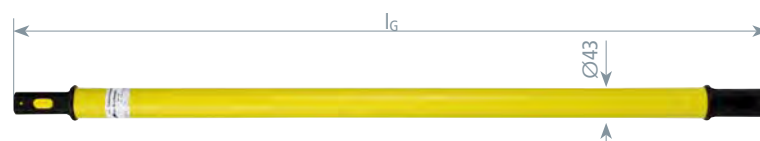

Type	HV STK 43 975	HV STK 43 1045	HV STK 43 2350
Part No.	766 077	766 076	766 073
Total length (l _G)	975 mm	1045 mm	2350 mm
Diameter	43 mm	43 mm	43 mm
DB drawing No.	3 Ebgw 02.53	3 Ebgw 02.53	3 Ebgw 02.51





Extension handle



	Type	HV STK RW 43 975	HV STK RW 43 1045
	Part No.	766 079	766 078
	Total length (l _G)	975 mm	1045 mm
	Diameter	43 mm	43 mm
	DB drawing No.	3 Ebgw 01.68	3 Ebgw 01.68

Extension handle with aluminium plug-in coupling



	Type	HV ALSTK 1035
	Part No.	769 517
	Total length (l _G)	1035 mm
	Diameter	43 mm

RW Extension handle with aluminium plug-in coupling



	Type	HV ALSTK RW 1035
	Part No.	769 518
	Total length (l _G)	1035 mm
	Diameter	43 mm

RW Extension handle with aluminium plug-in coupling and ring eye



	Type	HV ALSTK AK RW 1035
	Part No.	769 519
	Total length (l _G)	1035 mm
	Diameter	43 mm

Adapter

Adapter with M12 threaded bushing

With plug-in coupling.



Type	AD M12 STK 30 350	AD PHE4 STK 410
Part No.	766 352	783 930
Total length (l _G)	350 mm	410 mm
Diameter	30 mm	30 mm

Adapter with gear coupling

With plug-in coupling.

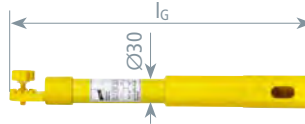

Type	AD ZK STK 30 360
Part No.	766 359
Total length (l _G)	360 mm
Diameter	30 mm

Adapter with cone-shaped support

With gear coupling and cone-shaped support, accommodates cleaning sponges (Part No. 766 056).

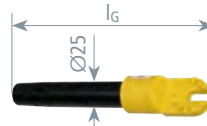

Type	AD ZK 25 200
Part No.	766 055
Dimensions	200 mm
Diameter	25 mm

Adapter with flat lock bushing

and plug-in coupling for attaching WOLF gardening tools



Type	AD FB18 7 STK SN7007
Part No.	766 321
Total length	345 mm
Dimension (bushing)	18 x 7 mm

Note: WOLF gardening tools with adapter are not protected against bridging (electrical safety)!

Adapter for animal guard

Adapter with gear coupling for mounting the 3M Animal Guard.

Type	AD ZK 3M 170
Part No.	766 059
Total length (l _G)	170 mm



NEW



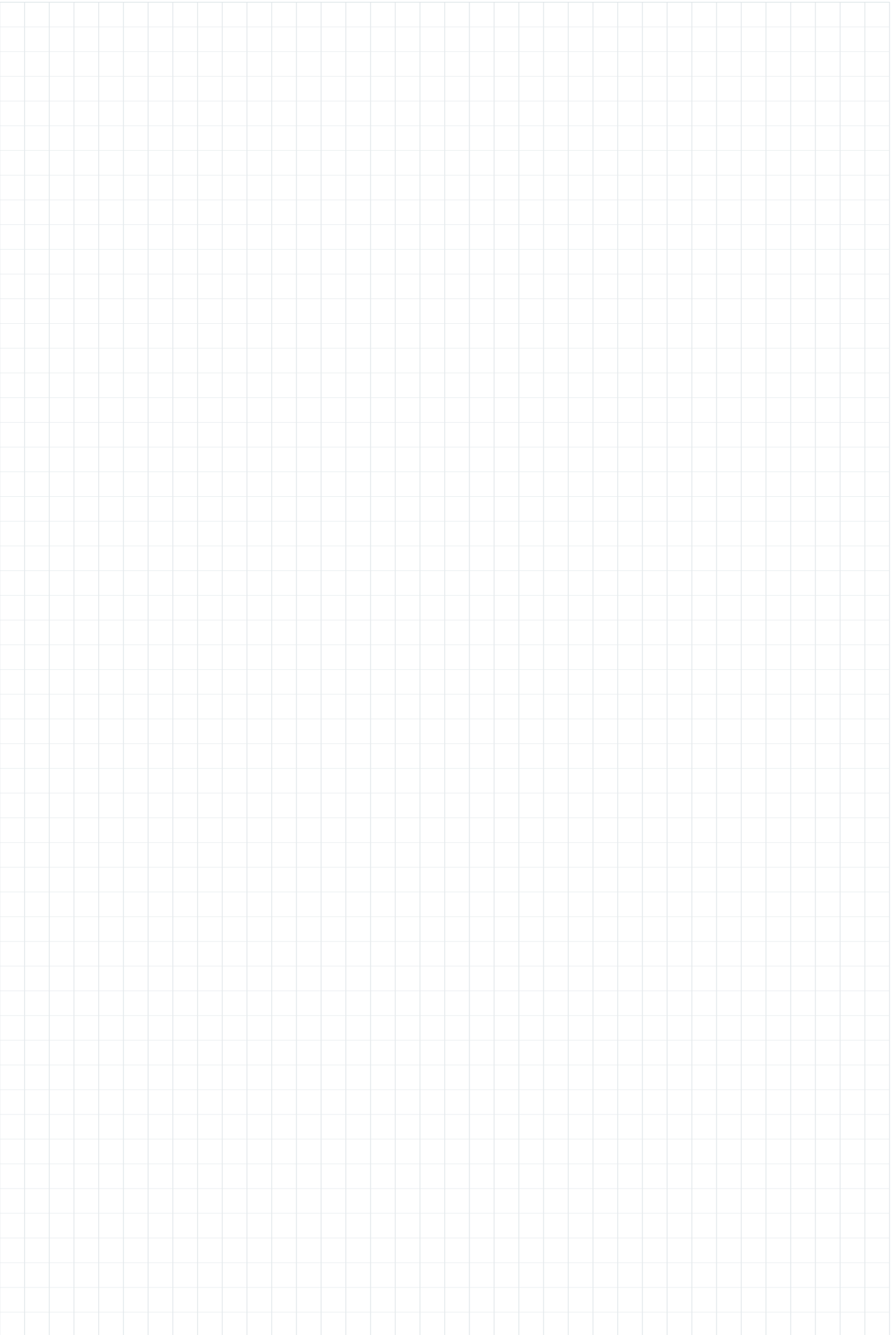

Part No. / GTIN* / PG / Weight / PU / SU / Page

Part No.	GTIN*	PG	Weight	PU	SU	Page
336 020	003941	05 00 04 01	118 g	1	pc(s)	60
336 025	003958	05 00 04 01	252 g	1	pc(s)	60
524 910	039339	01 50 50 01	2 g	1	pc(s)	59
524 912	039360	01 06 01 01	4 g	1	pc(s)	59
524 913	053250	01 06 01 01	8 g	1	pc(s)	59
525 001	004986	05 00 04 50	19 g	10	pc(s)	59
525 002	004993	05 00 04 50	37 g	10	pc(s)	59
525 910	390911	01 50 50 01	3 g	1	pc(s)	59
525 912	053267	01 50 50 01	5 g	1	pc(s)	59
525 916	053274	01 06 01 01	10 g	1	pc(s)	59
561 924	047280	01 50 50 01	26 g	1	pc(s)	59
561 925	056244	01 06 01 01	35 g	1	pc(s)	59
561 930	053298	01 06 01 01	39 g	1	pc(s)	59
561 931	053311	01 06 01 01	77 g	1	pc(s)	59
561 935	056053	01 06 01 01	42 g	1	pc(s)	59
644 000	030268	03 07 01 01	4.45 kg	1	pc(s)	75
700 000	004122	05 05 01 06	1.16 kg	1	pc(s)	167
700 002	004139	05 05 01 06	1.15 kg	1	pc(s)	167
700 003	004146	05 05 01 06	700 g	1	pc(s)	167
700 004	004153	05 05 01 06	1 kg	1	pc(s)	167
700 005	004160	05 05 01 06	707 g	1	pc(s)	167
700 006	004177	05 05 01 06	780 g	1	pc(s)	167
700 007	004184	05 05 01 06	780 g	1	pc(s)	167
700 008	004191	05 05 01 06	803 g	1	pc(s)	167
700 014	007208	05 05 01 06	1.71 kg	1	pc(s)	167
700 015	007192	05 05 01 06	1.41 kg	1	pc(s)	167
700 098	157422	05 00 02 03	180 g/Sa	1	Sa	151
700 099	157415	05 00 02 03	1.28 kg/m	1	m	151
705 500	000025	05 00 04 50	122 g	1	pc(s)	61
705 501	003927	05 00 04 01	152 g	1	pc(s)	60
705 504	008021	05 00 04 50	183 g	1	pc(s)	61
705 510	089587	05 00 04 50	240 g	1	pc(s)	61
706 200	004276	05 00 04 01	172 g	1	pc(s)	58
706 235	004290	05 00 04 01	219 g	1	pc(s)	58
706 239	155145	05 00 04 01	227 g	1	pc(s)	58
706 300	003675	05 00 04 01	129 g	1	pc(s)	57
706 600	004283	05 00 04 01	158 g	1	pc(s)	58
706 645	004306	05 00 04 01	274 g	1	pc(s)	58
707 200	004368	05 00 04 01	204 g	1	pc(s)	59
707 235	004382	05 00 04 01	259 g	1	pc(s)	59
707 600	004375	05 00 04 01	191 g	1	pc(s)	59
707 645	004399	05 00 04 01	299 g	1	pc(s)	59
712 001	011823	05 00 04 02	1.23 kg/m	1	m	68
715 001	011830	05 00 04 02	1.52 kg/m	1	m	68
715 312	150386	05 00 04 06	1.50 kg	1	pc(s)	70
715 313	154971	05 00 04 06	1.55 kg	1	pc(s)	70
715 314	132474	05 00 04 06	1.61 kg	1	pc(s)	70
715 315	135338	05 00 04 06	1.60 kg	1	pc(s)	70
716 001	010406	05 00 04 02	184 g/m	1	m	68
723 199	151703	05 03 01 01	750 g	1	pc(s)	150
725 001	011793	05 00 04 02	207 g/m	1	m	68
725 010	003750	05 00 04 01	410 g	1	pc(s)	58
725 012	003767	05 00 04 01	400 g	1	pc(s)	58
725 014	003774	05 00 04 01	385 g	1	pc(s)	58
725 016	003781	05 00 04 01	365 g	1	pc(s)	58
725 018	078048	05 00 04 01	345 g	1	pc(s)	58
725 020	003804	05 00 04 01	320 g	1	pc(s)	58

Part No.	GTIN*	PG	Weight	PU	SU	Page
728 312	128712	05 00 04 06	270 g	1	pc(s)	73
728 313	157132	05 00 04 06	612 g	1	pc(s)	73
728 501	079618	05 00 04 07	900 g	1	pc(s)	63
728 502	079571	05 00 04 07	708 g	1	pc(s)	63
728 503	079564	05 00 04 07	453 g	1	pc(s)	63
728 506	147904	05 00 04 09	867 g	1	pc(s)	62
728 516	147898	05 00 04 09	1.44 kg	1	pc(s)	62
728 522	147874	05 00 04 09	676 g	1	pc(s)	62
728 526	147881	05 00 04 09	934 g	1	pc(s)	62
728 620	147843	05 00 04 09	985 g	1	pc(s)	62
728 625	147867	05 00 04 09	984 g	1	pc(s)	62
735 001	011847	05 00 04 02	366 g/m	1	m	68
740 124	051072	05 00 04 06	255 g	1	pc(s)	96
745 016	052000	05 00 04 13	467 g	1	pc(s)	104
745 017	052017	05 00 04 13	277 g	1	pc(s)	104
745 018	052048	05 00 04 13	271 g	1	pc(s)	104
745 021	155336	05 00 04 13	289 g	1	pc(s)	105
745 022	353138	05 00 04 13	114 g	1	pc(s)	104
745 105	104457	05 00 04 15	1.83 kg	1	pc(s)	108
745 106	104495	05 05 01 02	890 g	1	pc(s)	108
745 107	104501	05 00 04 15	286 g	1	pc(s)	108
745 108	104518	05 00 04 15	20 g	1	pc(s)	109
745 109	104525	05 00 04 15	18 g	1	pc(s)	109
745 115	155299	05 00 04 15	296 g	1	pc(s)	109
745 121	268418	05 00 04 15	415 g	1	pc(s)	109
745 201	008007	05 00 04 15	65 g	1	pc(s)	105
745 202	007871	05 00 04 15	90 g	1	pc(s)	105
745 203	008014	05 00 04 15	102 g	1	pc(s)	105
745 204	018655	05 00 04 15	145 g	1	pc(s)	105
745 302	052024	05 00 04 15	110 g	1	pc(s)	104
745 400	006959	05 00 04 13	250 g	1	pc(s)	106
745 414	116085	05 00 04 11	285 g	1	pc(s)	110
745 415	116092	05 00 04 11	275 g	1	pc(s)	110
745 500	007888	05 00 04 13	7.57 kg	1	pc(s)	102
745 502	072213	05 00 04 13	360 g	1	pc(s)	105
745 503	133570	05 00 04 12	154 g	1	pc(s)	101
745 506	307667	05 00 04 13	114 g	1	pc(s)	105
745 508	149366	05 00 04 13	137 g	1	pc(s)	105
745 509	149915	05 00 04 13	127 g	1	pc(s)	109
745 510	155671	05 00 04 13	225 g	1	pc(s)	101
745 602	072220	05 00 04 13	580 g	1	pc(s)	105
745 900	082731	05 05 01 01	3.71 kg	1	pc(s)	159
745 901	083530	05 00 04 12	6.89 kg	1	pc(s)	99
745 902	093591	05 05 01 02	1.62 kg	1	pc(s)	160
745 903	093577	05 00 04 12	7 kg	1	pc(s)	99
745 905	082021	05 00 04 12	75 g	1	pc(s)	101
745 910	082038	05 00 04 12	190 g	1	pc(s)	101
745 915	082045	05 00 04 12	420 g	1	pc(s)	101
745 921	082069	05 00 04 12	216 g	1	pc(s)	101
745 922	082434	05 00 04 12	220 g	1	pc(s)	101
745 952	137066	05 05 01 02	4.90 kg	1	pc(s)	160
745 953	137073	05 05 01 02	4.95 kg	1	pc(s)	160
750 001	011809	05 00 04 02	535 g/m	1	m	68
750 041	126688	05 00 04 06	4.22 kg	1	pc(s)	95
750 042	126695	05 00 04 06	3.89 kg	1	pc(s)	95
750 196	123823	05 00 04 06	26.58 kg	1	pc(s)	90
750 200	123830	05 00 04 06	16.95 kg	1	pc(s)	92
750 210	123793	05 00 04 06	13.44 kg	1	pc(s)	90
750 211	123809	05 00 04 06	15.55 kg	1	pc(s)	91
750 212	123847	05 00 04 06	13 kg	1	pc(s)	92
750 213	123861	05 00 04 06	8.76 kg	1	pc(s)	93
750 214	123816	05 00 04 06	15.60 kg	1	pc(s)	91
750 215	123878	05 00 04 06	7.30 kg	1	pc(s)	93

Part No.	GTIN*	PG	Weight	PU	SU	Page
750 216	157255	05 00 04 06	26.58 kg	1	pc(s)	90
750 217	157262	05 00 04 06	17.08 kg	1	pc(s)	92
750 218	157224	05 00 04 06	14.73 kg	1	pc(s)	90
750 219	157231	05 00 04 06	16.87 kg	1	pc(s)	91
750 221	157248	05 00 04 06	15.51 kg	1	pc(s)	91
750 500	000032	05 00 04 01	250 g	1	pc(s)	61
751 040	006041	05 00 04 02	2.6 kg	1	pc(s)	96
751 085	006058	05 00 04 02	4.98 kg	1	pc(s)	96
751 086	126626	05 00 04 06	8.99 kg	1	pc(s)	94
751 087	126633	05 00 04 06	9.13 kg	1	pc(s)	94
751 120	006065	05 00 04 02	6.86 kg	1	pc(s)	96
751 121	126640	05 00 04 06	11.14 kg	1	pc(s)	94
751 122	126657	05 00 04 06	11.41 kg	1	pc(s)	94
751 126	126664	05 00 04 06	10.88 kg	1	pc(s)	94
751 127	126671	05 00 04 06	11.01 kg	1	pc(s)	94
751 130	041776	05 00 04 02	7.39 kg	1	pc(s)	96
751 140	018570	05 00 04 02	7.93 kg	1	pc(s)	96
751 150	084520	05 00 04 06	4.53 kg	1	pc(s)	95
751 191	126602	05 00 04 06	8.82 kg	1	pc(s)	95
751 192	123885	05 00 04 06	6.68 kg	1	pc(s)	96
751 193	123892	05 00 04 06	10.28 kg	1	pc(s)	95
751 196	157767	05 00 04 06	8.53 kg	1	pc(s)	96
751 197	157774	05 00 04 06	14.41 kg	1	pc(s)	96
752 040	230187	05 00 04 03	1.09 kg	1	pc(s)	96
752 041	230569	05 00 04 05	3.18 kg	1	pc(s)	95
752 042	230576	05 00 04 05	3.57 kg	1	pc(s)	95
752 085	230637	05 00 04 03	2.32 kg	1	pc(s)	96
752 086	230217	05 00 04 07	7.02 kg	1	pc(s)	94
752 087	230422	05 00 04 07	7.33 kg	1	pc(s)	94
752 120	230644	05 00 04 03	3.28 kg	1	pc(s)	96
752 121	230316	05 00 04 07	8.32 kg	1	pc(s)	94
752 122	230453	05 00 04 07	8.48 kg	1	pc(s)	94
752 126	230262	05 00 04 07	8.05 kg	1	pc(s)	94
752 127	230439	05 00 04 07	8.21 kg	1	pc(s)	94
752 191	230330	05 00 04 07	6.34 kg	1	pc(s)	95
752 192	230590	05 00 04 07	4.66 kg	1	pc(s)	96
752 193	230538	05 00 04 07	7.38 kg	1	pc(s)	95
752 196	230545	05 00 04 07	6.52 kg	1	pc(s)	96
752 197	230552	05 00 04 07	7.55 kg	1	pc(s)	96
754 200	004207	05 00 04 01	131 g	1	pc(s)	57
754 205	097865	05 00 04 01	137 g	1	pc(s)	57
754 235	004221	05 00 04 01	184 g	1	pc(s)	57
754 238	131309	05 00 04 01	180 g	1	pc(s)	57
754 600	004214	05 00 04 01	116 g	1	pc(s)	57
754 645	004238	05 00 04 01	287 g	1	pc(s)	57
755 200	000087	05 00 04 01	220 g	1	pc(s)	57
755 225	004498	05 00 04 01	265 g	1	pc(s)	57
755 245	000070	05 00 04 01	278 g	1	pc(s)	57
755 501	003934	05 00 04 01	298 g	1	pc(s)	60
755 600	000094	05 00 04 01	204 g	1	pc(s)	57
755 626	079625	05 00 04 01	301 g	1	pc(s)	58
755 627	077768	05 00 04 01	311 g	1	pc(s)	58
755 636	079670	05 00 04 01	310 g	1	pc(s)	58
755 645	000100	05 00 04 01	319 g	1	pc(s)	57
755 646	079632	05 00 04 01	330 g	1	pc(s)	58
756 200	004313	05 00 04 01	357 g	1	pc(s)	58
756 245	004337	05 00 04 01	434 g	1	pc(s)	58
756 300	003682	05 00 04 01	212 g	1	pc(s)	57
756 600	004320	05 00 04 01	356 g	1	pc(s)	58
756 645	004344	05 00 04 01	470 g	1	pc(s)	58
757 200	004405	05 00 04 01	395 g	1	pc(s)	59
757 245	004429	05 00 04 01	454 g	1	pc(s)	59

Part No.	GTIN*	PG	Weight	PU	SU	Page
757 600	004412	05 00 04 01	370 g	1	pc(s)	59
757 645	004436	05 00 04 01	491 g	1	pc(s)	59
758 001	004030	05 00 04 16	2.21 kg	1	pc(s)	154
758 003	004047	05 00 04 16	1.95 kg	1	pc(s)	154
758 015	041608	05 00 04 16	2.62 kg	1	pc(s)	154
758 020	098992	05 00 04 16	1.34 kg	1	pc(s)	153
758 021	099005	05 00 04 16	1.10 kg	1	pc(s)	153
758 022	099012	05 00 04 16	650 g	1	pc(s)	153
758 025	127838	05 00 04 16	1.49 kg	1	pc(s)	155
758 028	132450	05 00 04 16	4.16 kg	1	pc(s)	155
758 031	229853	05 00 04 16	2.10 kg	1	pc(s)	155
758 036	133884	05 00 04 16	203 g	1	pc(s)	156
758 075	247789	05 00 04 16	1.08 kg	1	pc(s)	156
758 085	247819	05 00 04 16	750 g	1	pc(s)	156
758 095	247826	05 00 04 16	1.32 kg	1	pc(s)	157
758 099	287587	05 00 04 16	3.06 kg	1	pc(s)	156
758 116	247918	05 00 04 16	220 g	1	pc(s)	157
758 125	247925	05 00 04 16	260 g	1	pc(s)	157
758 135	247932	05 00 04 16	301 g	1	pc(s)	157
758 216	247949	05 00 04 16	282 g	1	pc(s)	157
759 706	259232	05 00 03 11	1.30 kg	1	pc(s)	46
759 712	259256	05 00 03 11	1.15 kg	1	pc(s)	46
759 716	259270	05 00 03 11	1.52 kg	1	pc(s)	46
759 736	259263	05 00 03 11	1.51 kg	1	pc(s)	46
759 798	259317	05 00 03 50	2 g	1	pc(s)	168
759 799	259294	05 00 03 50	31 g	1	pc(s)	168
761 001	125179	05 00 04 11	400 g	1	pc(s)	81
761 002	125186	05 00 04 11	400 g	1	pc(s)	81
761 003	134348	05 00 04 11	840 g	1	pc(s)	81
761 004	134355	05 00 04 11	1.99 kg	1	pc(s)	81
761 010	000155	05 00 04 11	980 g	1	pc(s)	80
761 011	000230	05 00 04 11	1.05 kg	1	pc(s)	80
761 015	000162	05 00 04 11	1.35 kg	1	pc(s)	80
761 016	000247	05 00 04 11	1.36 kg	1	pc(s)	80
761 070	136212	05 00 04 11	800 g	1	pc(s)	81
761 075	136229	05 00 04 11	800 g	1	pc(s)	81
763 100	125155	05 00 01 02	600 g	1	pc(s)	13
763 111	137226	05 00 01 02	580 g	1	pc(s)	13
763 211	081567	05 00 05 01	8 kg	1	pc(s)	113
763 221	081574	05 00 05 01	8 kg	1	pc(s)	113
763 231	081581	05 00 05 01	8 kg	1	pc(s)	113
763 241	081598	05 00 05 01	8 kg	1	pc(s)	113
763 610	003286	05 00 01 02	962 g	1	pc(s)	13
763 611	076921	05 00 01 02	610 g	1	pc(s)	13
763 612	078635	05 00 01 02	800 g	1	pc(s)	13
763 615	003309	05 00 01 02	1.42 kg	1	pc(s)	13
763 620	003316	05 00 01 02	800 g	1	pc(s)	13
763 710	098558	05 00 01 01	1.20 kg	1	pc(s)	19
763 711	098565	05 00 01 01	442 g	1	pc(s)	19
763 712	098572	05 00 01 01	49 g	1	pc(s)	19
765 001	051805	05 00 04 11	190 g	1	pc(s)	81
765 005	051775	05 00 01 02	117 g	1	pc(s)	170
765 006	156104	05 00 04 11	315 g	1	pc(s)	83
765 009	051782	05 00 01 02	145 g	1	pc(s)	170
765 040	093751	05 00 01 03	2.13 kg	1	pc(s)	15
765 041	093768	05 00 01 03	2.28 kg	1	pc(s)	15
765 042	093775	05 00 01 03	2.59 kg	1	pc(s)	15
765 050	093782	05 00 01 03	2.15 kg	1	pc(s)	15
765 051	093799	05 00 01 03	2.29 kg	1	pc(s)	15
765 052	093805	05 00 01 03	2.59 kg	1	pc(s)	15
766 001	017825	05 00 01 01	416 g	1	pc(s)	10
766 002	017832	05 00 01 01	810 g	1	pc(s)	10

Part No. / GTIN* / PG / Weight / PU / SU / Page

Part No.	GTIN*	PG	Weight	PU	SU	Page
766 036	105584	05 05 01 02	968 g	1	pc(s)	159
766 037	125940	05 00 01 01	6.56 kg	1	pc(s)	173
766 038	105355	05 00 01 01	275 g	1	pc(s)	168
766 039	105362	05 05 01 04	712 g	1	pc(s)	161
766 040	113046	05 00 01 04	820 g	1	pc(s)	14
766 041	113053	05 00 01 04	1 kg	1	pc(s)	14
766 042	113060	05 00 01 04	1.12 kg	1	pc(s)	14
766 048	120433	05 00 01 01	2.60 kg	1	pc(s)	173
766 049	108059	05 00 01 01	165 g	1	pc(s)	171
766 055	125063	05 00 01 01	120 g	1	pc(s)	177
766 056	125070	05 00 01 01	204 g	1	pc(s)	171
766 057	125087	05 00 01 50	75 g/Sa	1	Sa	171
766 059	378681	05 00 01 01	110 g	1	pc(s)	177
766 072	126114	05 00 01 01	400 g	1	pc(s)	174
766 073	126121	05 00 03 50	1.60 kg	1	pc(s)	175
766 074	120952	05 00 04 11	1.20 kg	1	pc(s)	171
766 075	120471	05 00 01 01	520 g	1	pc(s)	174
766 076	120464	05 00 04 11	800 g	1	pc(s)	175
766 077	120457	05 00 04 11	740 g	1	pc(s)	175
766 078	120969	05 00 04 11	1 kg	1	pc(s)	176
766 079	120976	05 00 04 11	1 kg	1	pc(s)	176
766 100	125117	05 00 01 01	400 g	1	pc(s)	11
766 105	125988	05 00 03 50	10 g	1	pc(s)	168
766 111	137295	05 00 01 01	560 g	1	pc(s)	11
766 115	136038	05 00 01 50	725 g	1	pc(s)	174
766 116	153073	05 00 01 01	1.05 kg	1	pc(s)	174
766 117	153080	05 00 01 01	645 g	1	pc(s)	174
766 120	136052	05 00 01 50	690 g	1	pc(s)	175
766 122	134249	05 00 01 01	800 g	1	pc(s)	11
766 164	121751	05 00 01 02	400 g	1	pc(s)	170
766 169	230675	05 00 01 02	550 g	1	pc(s)	170
766 298	007864	05 05 01 01	3.70 kg	1	pc(s)	159
766 300	007628	05 05 01 01	1.20 kg	1	pc(s)	159
766 301	125124	05 00 01 01	400 g	1	pc(s)	11
766 302	051317	05 00 04 13	4.38 kg	1	pc(s)	102
766 310	137318	05 00 01 01	560 g	1	pc(s)	11
766 311	017856	05 00 01 01	419 g	1	pc(s)	10
766 312	311985	05 00 01 01	540 g	1	pc(s)	10
766 313	115040	05 00 01 50	413 g	1	pc(s)	166
766 315	008281	05 00 01 01	820 g	1	pc(s)	10
766 321	129528	05 00 01 50	187 g	1	pc(s)	177
766 322	134256	05 00 01 01	800 g	1	pc(s)	11
766 328	135765	05 00 01 01	283 g	1	pc(s)	172
766 331	115002	05 00 01 01	375 g	1	pc(s)	172
766 332	137325	05 00 01 01	2.38 kg	1	pc(s)	11
766 335	115033	05 00 01 50	400 g	1	pc(s)	175
766 340	125056	05 00 01 01	3 kg	1	pc(s)	20
766 352	136069	05 00 01 50	250 g	1	pc(s)	177
766 356	121799	05 00 01 50	400 g	1	pc(s)	175
766 358	136137	05 00 01 50	200 g	1	pc(s)	174
766 359	134379	05 00 01 50	200 g	1	pc(s)	177
766 362	230705	05 00 01 01	635 g	1	pc(s)	173
766 363	121737	05 00 01 01	600 g	1	pc(s)	173
766 364	128262	05 00 01 01	240 g	1	pc(s)	170
766 365	121768	05 00 01 01	200 g	1	pc(s)	170
766 366	121782	05 00 01 50	600 g	1	pc(s)	175
766 367	137042	05 00 01 01	600 g	1	pc(s)	173
766 368	115026	05 00 01 01	340 g	1	pc(s)	172
766 369	125025	05 00 01 01	388 g	1	pc(s)	172
766 371	139909	05 00 01 01	560 g	1	pc(s)	18
766 372	139916	05 00 01 01	1.24 kg	1	pc(s)	18
766 390	282810	05 00 01 05	1.55 kg	1	pc(s)	16
766 395	365988	05 00 01 05	67 g	1	pc(s)	16
766 456	121812	05 00 01 50	800 g	1	pc(s)	175
766 466	121805	05 00 01 50	85 g	1	pc(s)	175
766 469	139893	05 00 01 01	3.42 kg	1	pc(s)	18

Part No.	GTIN*	PG	Weight	PU	SU	Page
766 520	136243	05 00 01 50	643 g	1	pc(s)	175
766 542	051706	05 00 03 09	71 g	1	pc(s)	44
766 543	051683	05 05 01 03	148 g	1	pc(s)	44
766 601	056596	05 05 01 03	319 g	1	pc(s)	160
766 602	056626	05 05 01 03	1.31 kg	1	pc(s)	160
766 605	054370	05 50 50 01	2 g	1	pc(s)	168
766 611	146549	05 00 03 50	94 g/Sa	1	Sa	168
766 614	056916	05 05 01 03	600 g	1	pc(s)	161
766 616	126091	05 00 03 02	5.09 kg	1	pc(s)	36
766 617	101760	05 00 03 02	4.95 kg	1	pc(s)	36
766 618	148277	05 00 03 50	24 g	1	pc(s)	168
766 619	120488	05 00 03 02	600 g	1	pc(s)	170
766 660	302464	05 00 03 09	460 g	1	pc(s)	44
766 665	302488	05 00 03 09	460 g	1	pc(s)	44
766 677**	120495	05 00 03 02	2.1 kg		www.dehn-international.com	
766 678**	126107	05 00 03 02	2.3 kg		www.dehn-international.com	
766 704	069749	05 05 01 04	720 g	1	pc(s)	161
766 706	094307	05 00 03 07	800 g	1	pc(s)	37
766 710	094314	05 00 03 07	1.70 kg	1	pc(s)	37
766 720	094321	05 00 03 07	1.70 kg	1	pc(s)	37
766 888	125209	05 00 03 50	63 g	1	pc(s)	166
766 889	125193	05 00 03 50	172 g	1	pc(s)	166
766 913	051836	05 00 03 50	42 g	1	pc(s)	164
766 915	088207	05 00 03 50	220 g	1	pc(s)	164
766 916	106840	05 00 03 50	125 g	1	pc(s)	165
766 923	074590	05 00 03 50	71 g	1	pc(s)	164
766 924	094840	05 00 03 50	46 g	1	pc(s)	164
766 925	091672	05 00 03 50	10 g	1	pc(s)	164
766 927	097452	05 00 03 50	12 g	1	pc(s)	164
766 940	080485	05 00 03 50	145 g	1	pc(s)	165
766 941	080478	05 00 03 50	150 g	1	pc(s)	165
766 950	090668	05 00 03 50	339 g	1	pc(s)	166
766 960	109629	05 00 03 50	310 g	1	pc(s)	165
766 994	247062	05 05 01 02	3.31 kg	1	pc(s)	159
766 995	247147	05 05 01 02	4.38 kg	1	pc(s)	159
766 996	128170	05 05 01 03	4 kg	1	pc(s)	160
766 998	115286	05 05 01 02	3.36 kg	1	pc(s)	159
767 101	069541	05 00 03 12	60 g	1	pc(s)	48
767 102	074064	05 00 03 12	62 g	1	pc(s)	48
767 107	105577	05 05 01 02	880 g	1	pc(s)	160
767 110	070905	05 00 03 12	119 g	1	pc(s)	48
767 112	074361	05 00 03 12	150 g	1	pc(s)	49
767 122	074385	05 00 03 12	185 g	1	pc(s)	50
767 125	130319	05 00 03 01	1.26 kg	1	pc(s)	29
767 132	073005	05 00 03 12	640 g	1	pc(s)	51
767 133	073494	05 00 03 12	85 g	1	pc(s)	52
767 136	081109	05 00 03 12	65 g	1	pc(s)	52
767 139	136953	05 00 03 12	820 g	1	pc(s)	51
767 150	139473	05 00 03 12	1.94 kg	1	pc(s)	50
767 413	128750	05 00 03 02	1.77 kg	1	pc(s)	35
767 415	081116	05 00 03 02	1.52 kg	1	pc(s)	35
767 416	084247	05 00 03 02	2.62 kg	1	pc(s)	34
767 500	105676	05 05 01 03	280 g	1	pc(s)	51
767 539	306769	05 00 03 06	1.4 kg	1	pc(s)	40
767 541	115712	05 00 03 06	1.2 kg	1	pc(s)	40
767 542	086616	05 00 03 06	5.35 kg	1	pc(s)	40
767 547	158276	05 00 03 06	2 kg	1	pc(s)	41
767 552	115736	05 00 03 06	2 kg	1	pc(s)	41
767 564**	143784	05 00 03 06	464 g		www.dehn-international.com	
767 565	143760	05 00 03 06	2.03 kg	1	pc(s)	39
767 571	124967	05 00 03 06	1.99 kg	1	pc(s)	39
767 572	124974	05 00 03 06	2.01 kg	1	pc(s)	39
767 573	134270	05 00 03 06	3.57 kg	1	pc(s)	39
767 574	125971	05 05 01 03	500 g	1	pc(s)	161
767 576**	124998	05 00 03 06	214 g		www.dehn-international.com	

Part No.	GTIN*	PG	Weight	PU	SU	Page
767 577**	125001	05 00 03 06	380 g		www.dehn-international.com	
767 591**	146785	05 00 03 06	809 g		www.dehn-international.com	
767 592**	146792	05 00 03 06	465 g		www.dehn-international.com	
767 593**	146808	05 00 03 06	471 g		www.dehn-international.com	
767 610	135208	05 00 03 08	4.40 kg	1	pc(s)	42
767 614	135307	05 00 03 08	6 kg	1	pc(s)	42
767 636	155886	05 00 03 08	2.31 kg	1	pc(s)	43
767 637	155879	05 00 03 08	2.10 kg	1	pc(s)	43
767 639	155817	05 00 03 08	2.40 kg	1	pc(s)	43
767 640	155978	05 00 03 08	2.10 kg	1	pc(s)	43
767 645	156067	05 00 03 08	2.60 kg	1	pc(s)	43
767 647	156081	05 00 03 08	2.10 kg	1	pc(s)	43
767 666	157071	05 00 03 08	2.20 kg	1	pc(s)	42
767 671	156807	05 00 03 08	2.60 kg	1	pc(s)	43
767 701	071292	05 05 01 01	5.70 kg	1	pc(s)	159
767 703	070899	05 00 03 01	1.01 kg	1	pc(s)	29
767 706	070837	05 00 03 01	1.01 kg	1	pc(s)	29
767 707	131620	05 00 03 01	1.85 kg	1	pc(s)	29
767 710	070851	05 00 03 01	1.01 kg	1	pc(s)	29
767 711	070820	05 00 03 01	1.16 kg	1	pc(s)	29
767 712	074699	05 50 50 01	37 g	1	pc(s)	168
767 713	094925	05 50 50 01	44 g	1	pc(s)	168
767 719	131699	05 00 03 01	1.85 kg	1	pc(s)	29
767 720	070844	05 00 03 01	1.89 kg	1	pc(s)	29
767 721	070868	05 00 03 01	1.23 kg	1	pc(s)	29
767 722**	113183	05 00 03 01	474 g		www.dehn-international.com	
767 724	125902	05 00 03 01	4.22 kg	1	pc(s)	33
767 730	070813	05 00 03 01	1.13 kg	1	pc(s)	29
767 731	070875	05 00 03 01	1.29 kg	1	pc(s)	29
767 733	070882	05 00 03 01	1.29 kg	1	pc(s)	29
767 734**	115149	05 00 03 01	420 g		www.dehn-international.com	
767 740	071063	05 00 03 01	1.45 kg	1	pc(s)	30
767 750	071070	05 00 03 01	1.51 kg	1	pc(s)	30
767 756	132047	05 00 03 01	1.95 kg	1	pc(s)	29
767 757	132054	05 00 03 01	1.13 kg	1	pc(s)	29
767 758	132030	05 00 03 01	1.16 kg	1	pc(s)	29
767 760	072947	05 00 03 01	177 g	1	pc(s)	169
767 761	072954	05 00 03 01	282 g	1	pc(s)	169
767 762	072961	05 00 03 01	352.9 g	1	pc(s)	169
767 763	072978	05 00 03 01	528.8 g	1	pc(s)	169
767 764	072114	05 00 03 01	506 g	1	pc(s)	169
767 766	091696	05 00 03 01	129 g	1	pc(s)	169
767 767	090378	05 00 03 01	440 g	1	pc(s)	169
767 768	113190	05 00 03 01	445 g	1	pc(s)	169
767 769	139831	05 00 03 01	1.23 kg	1	pc(s)	29
767 771	115118	05 00 03 01	600 g	1	pc(s)	169
767 773	135567	05 00 03 01	1.2 kg	1	pc(s)	29
767 774	131637	05 00 03 01	1.3 kg	1	pc(s)	29
767 776	096486	05 50 50 01	58 g	1	pc(s)	168
767 777	096493	05 50 50 01	46 g	1	pc(s)	168
767 779	093942	05 00 03 50	3 g	1	pc(s)	168
767 798	160019	05 00 03 01	1 kg	1	pc(s)	29
767 903	134737	05 00 03 01	992 g	1	pc(s)	30
767 906	134744	05 00 03 01	992 g	1	pc(s)	30
767 910	134751	05 00 03 01	992 g	1	pc(s)	30
767 920	134768	05 00 03 01	1.1 kg	1	pc(s)	30
767 921	097360	05 00 03 01	1.65 kg	1	pc(s)	31
767 922	097384	05 00 03 01	1.07 kg	1	pc(s)	31
767 930	134775	05 00 03 01	1.17 kg	1	pc(s)	30
767 931	097377	05 00 03 01	1.08 kg	1	pc(s)	31
767 932	097391	05 00 03 01	1.07 kg	1	pc(s)	31
767 940	134829	05 00 03 01	1.39 kg	1	pc(s)	30
767 941	134782	05 00 03 01	1.17 kg	1	pc(s)	30
767 944	277731	05 00 03 01	1.38 kg	1	pc(s)	30
767 950	134836	05 00 03 01	1.44 kg	1	pc(s)	30
767 951	134799	05 00 03 01	1.26 kg	1	pc(s)	30

Part No.	GTIN*	PG	Weight	PU	SU	Page
767 960	134812	05 00 03 01	1.32 kg	1	pc(s)	30
767 961	134805	05 00 03 01	1.32 kg	1	pc(s)	30
767 980	125926	05 00 03 01	5.98 kg	1	pc(s)	33
767 996	120181	05 05 01 03	2.30 kg	1	pc(s)	160
767 997	115682	05 05 01 02	2.42 kg	1	pc(s)	159
767 999	115262	05 05 01 02	3.40 kg	1	pc(s)	159
768 029	131415	05 00 04 08	5.20 kg	1	pc(s)	72
769 300	080867	05 00 04 11	2.80 kg	1	pc(s)	82
769 304	149144	05 00 04 11	2 kg	1	pc(s)	81
769 352	007345	05 00 04 11	3.70 kg	1	pc(s)	84
769 400	080881	05 00 04 11	3.68 kg	1	pc(s)	82
769 500	080904	05 00 04 11	4.68 kg	1	pc(s)	82
769 502	004542	05 00 04 11	5.60 kg	1	pc(s)	84
769 503	003996	05 00 04 11	1.64 kg	1	pc(s)	83
769 504	004559	05 00 04 11	1.60 kg	1	pc(s)	83
769 505	004566	05 00 04 11	1.46 kg	1	pc(s)	83
769 506	120938	05 00 04 11	5.25 kg	1	pc(s)	85
769 508	052383	05 00 04 11	4.50 kg	1	pc(s)	84
769 509	068230	05 05 01 04	358 g	1	pc(s)	161
769 511	135055	05 00 04 11	4.68 kg	1	pc(s)	72
769 515	157361	05 00 04 11	6.01 kg	1	pc(s)	85
769 516	157378	05 00 04 11	1.22 kg	1	pc(s)	171
769 517	157385	05 00 04 11	1.15 kg	1	pc(s)	176
769 518	157392	05 00 04 11	1.29 kg	1	pc(s)	176
769 519	157408	05 00 04 11	1.15 kg	1	pc(s)	176
769 701	242470	05 00 03 01	750 g	1	pc(s)	169
769 712	242517	05 00 03 01	5.23 kg	1	pc(s)	33
770 001	011762	05 00 04 02	753 g/m	1	m	68
771 230	144392	05 00 04 14	1.05 kg	1	pc(s)	107
771 231	144408	05 00 04 14	1.05 kg	1	pc(s)	107
771 232	144415	05 00 04 14	1.05 kg	1	pc(s)	107
771 233	144422	05 00 04 14	1.05 kg	1	pc(s)	107
771 316	150393	05 00 04 08	418 g	1	pc(s)	70
772 310	057593	05 00 04 08	469 g	1	pc(s)	69
772 311	057586	05 00 04 08	482 g	1	pc(s)	69
772 312	054431	05 00 04 08	480 g	1	pc(s)	77
772 313	054448	05 00 04 09	400 g	1	pc(s)	77
772 314	080171	05 00 04 08	446 g	1	pc(s)	73
772 320	057432	05 00 04 08	785 g	1	pc(s)	69
772 321	057449	05 00 04 08	756 g	1	pc(s)	69
772 322	054455	05 00 04 09	747 g	1	pc(s)	77
772 323	054462	05 00 04 09	876 g	1	pc(s)	77
772 324	080188	05 00 04 08	719 g	1	pc(s)	73
772 330	069220	05 00 04 08	560 g	1	pc(s)	70
772 331	066304	05 00 04 08	566 g	1	pc(s)	70
772 340	057456	05 00 04 08	878 g	1	pc(s)	70
772 341	057425	05 00 04 08	902 g	1	pc(s)	70
773 034	114562	05 00 04 08	634 g	1	pc(s)	70
773 130	057722	05 00 04 08	801 g	1	pc(s)	70
773 234	114555	05 00 04 08	661 g	1	pc(s)	70
773 236	114579	05 00 04 08	714 g	1	pc(s)	73
773 251	005990	05 00 04 08	901 g	1	pc(s)	79
773 330	057760	05 00 04 08	830 g	1	pc(s)	70
773 331	069244	05 00 04 08	793 g	1	pc(s)	73
774 034	114586	05 00 04 09	662 g	1	pc(s)	77
774 130	057739	05 00 04 09	780 g	1	pc(s)	77
774 234	114593	05 00 04 09	772 g	1	pc(s)	77
774 251	006003	05 00 04 09	955 g	1	pc(s)	79
774 330	057715	05 00 04 09	941 g	1	pc(s)	77
774 434	114609	05 00 04 09	712 g	1	pc(s)	77
774 530	057746	05 00 04 09	700 g	1	pc(s)	77

Part No. / GTIN* / PG / Weight / PU / SU / Page

Part No.	GTIN*	PG	Weight	PU	SU	Page
775 621	102545	05 00 04 09	311 g	1	pc(s)	78
775 626	102569	05 00 04 09	343 g	1	pc(s)	78
775 631	102552	05 00 04 09	290 g	1	pc(s)	78
775 636	102576	05 00 04 09	350 g	1	pc(s)	78
782 000	239401	05 02 10 02	4.03 kg	1	pc(s)	138
782 002	312562	05 02 10 02	5.23 kg	1	pc(s)	138
782 020	236509	05 02 10 02	10 g/Sa	1	Sa	138
782 022	236516	05 02 10 02	20 g/Sa	1	Sa	138
782 024	237193	05 02 10 02	36 g/Sa	1	Sa	138
782 028	237223	05 02 10 02	66 g/Sa	1	Sa	138
782 030	245792	05 02 10 02	1.19 kg	1	pc(s)	136
782 031	245815	05 02 10 02	1.19 kg	1	pc(s)	136
782 040	245822	05 02 10 02	784 g	1	pc(s)	136
782 041	245839	05 02 10 02	784 g	1	pc(s)	136
782 050	245846	05 02 10 02	851 g	1	pc(s)	136
782 051	245853	05 02 10 02	851 g	1	pc(s)	136
782 060	245860	05 02 10 02	27 g	1	pc(s)	137
782 077	273375	05 02 10 02	47 g	1	pc(s)	137
782 081	273344	05 02 10 02	50 g	1	pc(s)	137
782 085	273443	05 02 10 02	53 g	1	pc(s)	137
782 091	273474	05 02 10 02	60 g	1	pc(s)	137
782 098	274013	05 02 10 02	30 g/Sa	1	Sa	137
782 099	274006	05 02 10 02	45 g/Sa	1	Sa	137
783 003	310179	05 00 03 03	1.24 kg	1	pc(s)	25
783 006	310155	05 00 03 03	1.27 kg	1	pc(s)	25
783 010	297869	05 00 03 03	1.23 kg	1	pc(s)	25
783 011	310131	05 00 03 03	1.25 kg	1	pc(s)	28
783 013	310186	05 00 03 03	1.47 kg	1	pc(s)	25
783 020	310124	05 00 03 03	1.35 kg	1	pc(s)	25
783 022	310117	05 00 03 03	1.35 kg	1	pc(s)	28
783 030	310100	05 00 03 03	1.62 kg	1	pc(s)	25
783 033	310162	05 00 03 03	1.28 kg	1	pc(s)	28
783 045	310094	05 00 03 03	1.35 kg	1	pc(s)	28
783 066	310148	05 00 03 03	1.27 kg	1	pc(s)	28
783 103	317277	05 00 03 03	1.27 kg	1	pc(s)	26
783 106	317260	05 00 03 03	1.27 kg	1	pc(s)	26
783 110	317253	05 00 03 03	1.27 kg	1	pc(s)	26
783 120	317246	05 00 03 03	1.35 kg	1	pc(s)	26
783 130	317239	05 00 03 03	1.61 kg	1	pc(s)	26
783 141	317222	05 00 03 03	1.46 kg	1	pc(s)	26
783 151	317215	05 00 03 03	1.55 kg	1	pc(s)	26
783 161	317208	05 00 03 03	1.61 kg	1	pc(s)	26
783 231	310087	05 00 03 03	1.46 kg	1	pc(s)	25
783 233	310063	05 00 03 03	1.46 kg	1	pc(s)	28
783 235	310049	05 00 03 03	1.55 kg	1	pc(s)	25
783 240	310056	05 00 03 03	1.46 kg	1	pc(s)	25
783 243	310018	05 00 03 03	1.55 kg	1	pc(s)	28
783 245	310032	05 00 03 03	1.61 kg	1	pc(s)	25
783 250	309999	05 00 03 03	1.61 kg	1	pc(s)	25
783 255	309982	05 00 03 03	1.61 kg	1	pc(s)	28
783 270	309852	05 00 03 03	2.48 kg	1	pc(s)	27
783 275	309845	05 00 03 03	2.91 kg	1	pc(s)	27
783 280	317284	05 00 03 03	3.31 kg	1	pc(s)	27
783 285	316898	05 00 03 03	3.80 kg	1	pc(s)	27
783 290	316904	05 00 03 03	5.56 kg	1	pc(s)	27
783 332	310070	05 00 03 03	1.46 kg	1	pc(s)	26
783 335	310001	05 00 03 03	1.55 kg	1	pc(s)	26
783 342	310025	05 00 03 03	1.61 kg	1	pc(s)	26
783 345	309975	05 00 03 03	1.61 kg	1	pc(s)	26
783 395	309951	05 00 03 03	1.61 kg	1	pc(s)	26
783 420	309890	05 00 03 03	1.55 kg	1	pc(s)	26
783 430	309906	05 00 03 03	1.55 kg	1	pc(s)	26
783 460	309869	05 00 03 03	3.31 kg	1	pc(s)	27
783 511	309937	05 00 03 03	1.27 kg	1	pc(s)	28

Part No.	GTIN*	PG	Weight	PU	SU	Page
783 520	309913	05 00 03 03	1.55 kg	1	pc(s)	25
783 530	309968	05 00 03 03	1.61 kg	1	pc(s)	25
783 533	309920	05 00 03 03	1.61 kg	1	pc(s)	28
783 536	309944	05 00 03 03	1.61 kg	1	pc(s)	25
783 900	292505	05 00 01 01	443 g	1	pc(s)	172
783 905	292499	05 00 01 01	488 g	1	pc(s)	172
783 906	292482	05 00 01 01	702 g	1	pc(s)	172
783 920	292437	05 00 01 50	520 g	1	pc(s)	174
783 925	292444	05 00 01 50	745 g	1	pc(s)	174
783 930	292451	05 00 03 03	265 g	1	pc(s)	177
784 032	018679	05 00 04 08	969 g	1	pc(s)	73
784 038	138452	05 00 04 08	1.01 kg	1	pc(s)	73
784 085	018686	05 00 04 08	872 g	1	pc(s)	72
784 201	006591	05 00 04 08	880 g	1	pc(s)	71
784 301	006553	05 00 04 08	1.70 kg	1	pc(s)	71
784 352	006072	05 00 04 08	806 g	1	pc(s)	74
784 401	006614	05 00 04 08	1.30 kg	1	pc(s)	71
784 480	054479	05 00 04 08	600 g	1	pc(s)	72
784 501	006560	05 00 04 08	1.95 kg	1	pc(s)	71
784 755	054202	05 00 04 08	1.54 kg	1	pc(s)	74
784 756	230118	05 00 04 08	1.60 kg	1	pc(s)	74
785 100	087606	05 01 01 01	18 kg	1	pc(s)	118
785 109**	098176	05 01 01 01	504 g		www.dehn-international.com	
785 111	070257	05 05 01 04	612 g	1	pc(s)	161
785 112	106550	05 01 01 01	17.80 kg	1	pc(s)	118
785 119	098213	05 01 01 01	700 g	1	pc(s)	122
785 120**	087613	05 01 01 01	700 g		www.dehn-international.com	
785 121**	087620	05 01 01 01	110 g		www.dehn-international.com	
785 122**	087637	05 01 01 01	220 g		www.dehn-international.com	
785 123**	087644	05 01 01 01	430 g		www.dehn-international.com	
785 130**	087651	05 01 01 01	130 g		www.dehn-international.com	
785 131**	087668	05 01 01 01	160 g		www.dehn-international.com	
785 132**	087675	05 01 01 01	150 g		www.dehn-international.com	
785 140**	087682	05 01 01 01	340 g		www.dehn-international.com	
785 150**	087699	05 01 01 01	320 g		www.dehn-international.com	
785 151**	087705	05 01 01 01	260 g		www.dehn-international.com	
785 159	284517	05 01 01 01	120 g	1	pc(s)	121
785 160**	087712	05 01 01 01	90 g		www.dehn-international.com	
785 169	284753	05 01 01 01	312 g	1	pc(s)	121
785 170**	087729	05 01 01 01	255 g		www.dehn-international.com	
785 171**	082106	05 01 01 01	105 g		www.dehn-international.com	
785 172**	082113	05 01 01 01	100 g		www.dehn-international.com	
785 180**	073869	05 01 01 01	150 g		www.dehn-international.com	
785 181**	106413	05 01 01 01	195 g		www.dehn-international.com	
785 190**	110359	05 01 01 01	389 g		www.dehn-international.com	
785 200**	087354	05 01 01 01	180 g		www.dehn-international.com	
785 210**	087743	05 01 01 01	260 g		www.dehn-international.com	
785 212**	082120	05 01 01 01	71 g		www.dehn-international.com	
785 213	090279	05 01 01 01	320 g	1	pc(s)	121
785 214	090286	05 01 01 01	320 g	1	pc(s)	121
785 215	090293	05 01 01 01	320 g	1	pc(s)	121
785 216	090309	05 01 01 01	320 g	1	pc(s)	121
785 217	090316	05 01 01 01	320 g	1	pc(s)	121
785 218	090323	05 01 01 01	320 g	1	pc(s)	121
785 219	090330	05 01 01 01	320 g	1	pc(s)	121
785 220**	087750	05 01 01 01	82 g		www.dehn-international.com	
785 221**	087767	05 01 01 01	200 g		www.dehn-international.com	
785 223**	098183	05 01 01 01	290 g		www.dehn-international.com	
785 224**	106482	05 01 01 01	11 g/Sa		www.dehn-international.com	
785 225	136434	05 01 01 01	140 g	1	pc(s)	121
785 229**	106260	05 01 01 01	6 kg		www.dehn-international.com	
785 259**	106444	05 01 01 01	94 g		www.dehn-international.com	
785 274**	100015	05 01 01 01	32 g/Sa		www.dehn-international.com	
785 275**	100022	05 01 01 01	62 g/Sa		www.dehn-international.com	

Part No.	GTIN*	PG	Weight	PU	SU	Page
785 279**	100060	05 01 01 01	67 g/Sa	www.dehn-international.com		
785 280**	100039	05 01 01 01	60 g/Sa	www.dehn-international.com		
785 301**	106246	05 01 01 01	6 kg	www.dehn-international.com		
785 310	092013	05 01 01 01	12.70 kg	1	pc(s)	121
785 315**	106277	05 01 01 01	632 g	www.dehn-international.com		
785 316**	106284	05 01 01 01	95 g	www.dehn-international.com		
785 317**	106291	05 01 01 01	130 g	www.dehn-international.com		
785 318**	106307	05 01 01 01	152 g	www.dehn-international.com		
785 319**	106314	05 01 01 01	247 g	www.dehn-international.com		
785 320**	106321	05 01 01 01	88 g	www.dehn-international.com		
785 321**	106338	05 01 01 01	97 g	www.dehn-international.com		
785 322**	106345	05 01 01 01	132 g	www.dehn-international.com		
785 323**	106352	05 01 01 01	182 g	www.dehn-international.com		
785 324**	106369	05 01 01 01	89 g	www.dehn-international.com		
785 325**	106581	05 01 01 01	600 g	www.dehn-international.com		
785 329	284760	05 01 01 01	135 g	1	pc(s)	121
785 442	152847	05 05 01 05	280 g	1	pc(s)	162
785 443	152854	05 05 01 05	550 g	1	pc(s)	162
785 455	088337	05 01 01 05	3.60 kg	1	pc(s)	124
785 456	086821	05 01 01 05	3.60 kg/m	1	m	124
785 457	087880	05 01 01 05	36 kg	1	pc(s)	124
785 458	115064	05 01 01 05	5.80 kg/m	1	m	125
785 459	115057	05 01 01 05	56 kg	1	pc(s)	125
785 465	088733	05 01 01 05	41.50 kg	1	pc(s)	124
785 466	088030	05 01 01 05	830 g/m	1	pc(s)	124
785 467	088740	05 01 01 05	38 kg	1	pc(s)	124
785 468	088757	05 01 01 05	1.64 kg/m	1	m	124
785 471	088764	05 01 01 05	20 kg	1	pc(s)	124
785 472	087057	05 01 01 05	1.95 kg/m	1	m	124
785 490	086890	05 01 01 03	240 g	1	pc(s)	123
785 491	088306	05 01 01 03	140 g/Pa	1	Pa	123
785 492	086883	05 01 01 03	150 g/Pa	1	Pa	123
785 493	088894	05 01 01 03	160 g/Pa	1	Pa	123
785 494	088320	05 01 01 03	170 g/Pa	1	Pa	123
785 495	088900	05 01 01 03	290 g/Pa	1	Pa	123
785 496	088917	05 01 01 03	290 g/Pa	1	Pa	123
785 497	088924	05 01 01 03	660 g	1	pc(s)	123
785 502	087347	05 01 01 01	7.20 kg	1	pc(s)	117
785 506**	081444	05 01 01 01	5.3 kg	www.dehn-international.com		
785 515**	087361	05 01 01 01	68 g	www.dehn-international.com		
785 520**	087378	05 01 01 01	240 g	www.dehn-international.com		
785 521**	087385	05 01 01 01	107 g	www.dehn-international.com		
785 522**	087408	05 01 01 01	157 g	www.dehn-international.com		
785 523**	087415	05 01 01 01	211 g	www.dehn-international.com		
785 530**	087422	05 01 01 01	118 g	www.dehn-international.com		
785 540**	087439	05 01 01 01	100 g	www.dehn-international.com		
785 541**	087446	05 01 01 01	41 g	www.dehn-international.com		
785 542**	087453	05 01 01 01	42 g	www.dehn-international.com		
785 543**	087460	05 01 01 01	43 g	www.dehn-international.com		
785 550**	087477	05 01 01 01	104 g	www.dehn-international.com		
785 551**	106468	05 01 01 01	34 g	www.dehn-international.com		
785 552**	106543	05 01 01 01	47 g	www.dehn-international.com		
785 555**	087484	05 01 01 01	100 g	www.dehn-international.com		
785 560**	087491	05 01 01 01	52 g	www.dehn-international.com		
785 570**	087507	05 01 01 01	47 g	www.dehn-international.com		
785 580**	106574	05 01 01 01	48 g	www.dehn-international.com		
785 585**	106567	05 01 01 01	21 g	www.dehn-international.com		
785 590**	087538	05 01 01 01	50 g	www.dehn-international.com		
785 591**	087545	05 01 01 01	47 g	www.dehn-international.com		
785 592	087552	05 01 01 01	50 g	1	pc(s)	121
785 595**	087569	05 01 01 01	15 g/Sa	www.dehn-international.com		
785 596**	087576	05 01 01 01	18 g/Sa	www.dehn-international.com		
785 637	100701	05 00 02 01	14 g	10	pc(s)	21
785 638	086920	05 00 02 01	6 g	10	pc(s)	21
785 639	087019	05 00 02 01	15 g	10	pc(s)	21
785 640	087026	05 00 02 01	55 g	10	pc(s)	21

Part No.	GTIN*	PG	Weight	PU	SU	Page
785 641	087897	05 00 02 01	55 g	10	pc(s)	21
785 642	087903	05 00 02 01	75 g	10	pc(s)	21
785 643	087910	05 00 02 01	80 g	10	pc(s)	21
785 644	087927	05 00 02 01	80 g	10	pc(s)	21
785 645	086869	05 01 01 03	420 g	1	pc(s)	123
785 646	089174	05 01 01 05	760 g	1	pc(s)	124
785 647	087040	05 01 01 05	73 g	1	pc(s)	125
785 648	088047	05 01 01 05	19 g	1	pc(s)	125
785 649	088054	05 01 01 05	2 g	1	pc(s)	125
785 650	106536	05 00 02 01	22 g	10	pc(s)	21
785 652	111479	05 00 02 01	8 g	10	pc(s)	21
785 705	341449	05 02 01 03	400 g	1	pc(s)	132
785 706	341456	05 02 01 03	400 g	1	pc(s)	132
785 707	341487	05 02 01 03	400 g	1	pc(s)	132
785 708	341463	05 02 01 03	400 g	1	pc(s)	132
785 709	341470	05 02 01 03	400 g	1	pc(s)	132
785 721	360198	05 02 01 03	182 g	1	pc(s)	134
785 722	360242	05 02 01 03	294 g	1	pc(s)	134
785 723	360266	05 02 01 03	148 g	1	pc(s)	132
785 724	360310	05 02 01 03	52 g	1	pc(s)	162
785 738	274716	05 02 01 03	39 g	1	pc(s)	132
785 739	274723	05 02 01 03	5 g	1	pc(s)	132
785 746	138414	05 02 01 03	379 g	1	pc(s)	133
785 747	138421	05 02 01 03	483 g	1	pc(s)	133
785 748	138438	05 02 01 03	388 g	1	pc(s)	133
785 749	138445	05 02 01 03	446 g	1	pc(s)	133
785 753	245143	05 02 01 03	83 g	1	pc(s)	134
785 754	336391	05 02 01 04	271 g	1	pc(s)	131
785 755	152861	05 02 01 02	2.35 kg	1	pc(s)	129
785 756	152878	05 02 01 02	2.50 kg	1	pc(s)	129
785 757	152885	05 02 01 02	2.70 kg	1	pc(s)	129
785 758	245150	05 02 01 02	3.55 kg	1	pc(s)	129
785 759	329362	05 02 01 02	4.40 kg	1	pc(s)	129
785 760	336384	05 02 01 04	800 g	1	pc(s)	131
785 761	274198	05 02 01 03	400 g	1	pc(s)	133
785 762	274211	05 02 01 03	375 g	1	pc(s)	133
785 763	274228	05 02 01 03	380 g	1	pc(s)	133
785 764	274235	05 02 01 03	415 g	1	pc(s)	133
785 765	274242	05 02 01 03	395 g	1	pc(s)	133
785 766	274259	05 02 01 03	390 g	1	pc(s)	133
785 769	152007	05 02 01 02	1.67 kg	1	pc(s)	129
785 770	149458	05 02 01 02	1.71 kg	1	pc(s)	129
785 771	149465	05 02 01 02	1.86 kg	1	pc(s)	129
785 772	149472	05 02 01 02	2.53 kg	1	pc(s)	129
785 773	149489	05 02 01 02	1.90 kg	1	pc(s)	129
785 774	149502	05 02 01 02	1.94 kg	1	pc(s)	129
785 775	149519	05 02 01 02	2.59 kg	1	pc(s)	129
785 779	151994	05 02 01 02	1.49 kg	1	pc(s)	129
785 780	149526	05 02 01 02	1.54 kg	1	pc(s)	129
785 781	149533	05 02 01 02	1.63 kg	1	pc(s)	129
785 782	149540	05 02 01 02	1.66 kg	1	pc(s)	129
785 783	149557	05 02 01 02	1.76 kg	1	pc(s)	129
785 784	149564	05 02 01 02	1.80 kg	1	pc(s)	129
785 785	149571	05 02 01 02	2.04 kg	1	pc(s)	129
785 788	149588	05 02 01 02	112 g	1	pc(s)	129
785 789	149595	05 02 01 02	75 g/Pa	1	Pa	129
785 796	124912	05 02 01 01	163 g/Pa	1	Pa	130
785 797	124936	05 02 01 01	169 g/Pa	1	Pa	130
785 798	124943	05 02 01 01	180 g/Pa	1	Pa	130
785 799	124950	05 02 01 01	196 g/Pa	1	Pa	130
785 800	131019	05 02 01 01	202 g/Pa	1	Pa	130
785 808	242265	05 02 01 01	250 g/Pa	1	Pa	130
785 809	242296	05 02 01 01	270 g/Pa	1	Pa	130
785 810	242302	05 02 01 01	290 g/Pa	1	Pa	130
785 811	242319	05 02 01 01	310 g/Pa	1	Pa	130
785 812	242326	05 02 01 01	330 g/Pa	1	Pa	130

Part No. / GTIN* / PG / Weight / PU / SU / Page

Part No.	GTIN*	PG	Weight	PU	SU	Page
785 940	106253	05 01 01 01	10.85 kg	1	pc(s)	119
785 950	106383	05 01 01 01	27.30 kg	1	pc(s)	120
785 951**	106390	05 01 01 01	21.2 kg		www.dehn-international.com	
785 952**	106406	05 01 01 01	1.43 kg		www.dehn-international.com	
785 953**	106451	05 01 01 01	121 g		www.dehn-international.com	
786 741	365438	05 08 01 01	2.16 kg	1	pc(s)	141
786 742	365445	05 08 01 01	2.19 kg	1	pc(s)	141
786 743	365452	05 08 01 01	2.45 kg	1	pc(s)	141
786 744	365469	05 08 01 01	2.53 kg	1	pc(s)	141
786 745	365476	05 08 01 01	2.66 kg	1	pc(s)	141
786 746	365483	05 08 01 01	2.76 kg	1	pc(s)	141
786 751	365247	05 08 01 01	1.58 kg	1	pc(s)	142
786 752	365254	05 08 01 01	1.68 kg	1	pc(s)	142
786 753	365261	05 08 01 01	1.78 kg	1	pc(s)	142
786 754	365278	05 08 01 01	1.86 kg	1	pc(s)	142
786 755	365285	05 08 01 01	1.94 kg	1	pc(s)	142
786 756	365292	05 08 01 01	2.03 kg	1	pc(s)	142
786 761	365308	05 08 01 01	207 g	1	pc(s)	142
786 762	365315	05 08 01 01	226 g	1	pc(s)	142
786 763	365322	05 08 01 01	245 g	1	pc(s)	142
786 764	365339	05 08 01 01	251 g	1	pc(s)	142
786 765	365346	05 08 01 01	276 g	1	pc(s)	142
786 766	365360	05 08 01 01	300 g	1	pc(s)	142
786 770	365353	05 08 01 01	825 g	1	pc(s)	141
786 781	365377	05 08 01 01	372 g	1	pc(s)	142
786 782	365384	05 08 01 01	393 g	1	pc(s)	142
786 783	365391	05 08 01 01	413 g	1	pc(s)	142
786 784	365407	05 08 01 01	420 g	1	pc(s)	142
786 785	365414	05 08 01 01	428 g	1	pc(s)	142
786 786	365421	05 08 01 01	436 g	1	pc(s)	142
786 799	360372	05 08 01 03	234 g	1	pc(s)	143

Part No.	GTIN*	PG	Weight	PU	SU	Page
790 150	005365	05 00 04 09	450 g	1	pc(s)	78
790 160	018693	05 00 04 09	737 g	1	pc(s)	78
790 250	089495	05 00 04 01	193 g	1	pc(s)	60
790 251	089501	05 00 04 01	248 g	1	pc(s)	60
790 260	089518	05 00 04 01	180 g	1	pc(s)	60
790 261	089525	05 00 04 01	277 g	1	pc(s)	60
792 030	005853	05 00 04 09	610 g	1	pc(s)	78
792 190	068315	05 00 04 09	1.22 kg	1	pc(s)	78
792 450	051744	05 00 04 09	2.60 kg	1	pc(s)	79
792 451	230170	05 00 04 09	2.60 kg	1	pc(s)	79
792 453	054226	05 00 04 09	2.95 kg	1	pc(s)	79
792 454	230194	05 00 04 09	2.94 kg	1	pc(s)	79
795 001	011816	05 00 04 02	1 kg/m	1	m	68
795 040	077393	05 00 04 10	890 g	1	pc(s)	98
795 213	053243	05 00 04 10	114 g	1	pc(s)	98
795 214	051799	05 00 04 10	118 g	1	pc(s)	98
799 006	157347	05 00 04 09	4 kg	1	pc(s)	76
799 009	123298	05 00 04 09	5.10 kg	1	pc(s)	75
799 019	123304	05 00 04 09	328 g	1	pc(s)	75
799 100	237094	05 04 01 01	12.2 kg	1	pc(s)	148
923 110	092426	05 03 01 01	40 g	10	pc(s)	149
923 116	085978	05 03 01 01	42 g	10	pc(s)	150
923 117	093478	05 03 01 01	42 g	10	pc(s)	149
923 118	104969	05 03 01 01	38 g	10	pc(s)	150
923 119	104976	05 03 01 01	38 g	10	pc(s)	150

Variant No. / GTIN* / PG / Weight / PU / SU / Page

Variant No.	GTIN*	PG	Weight	PU	SU	Page
V1KPFXR	165427	05 00 04 04	9.85 kg	1	pc(s)	87
V1RC3P2	163737	05 00 04 13	587 g	1	pc(s)	103
V2KWXUL	165588	05 00 04 04	4.99 kg	1	pc(s)	89
V2WPYVF	165601	05 00 04 04	8.06 kg	1	pc(s)	89
V3CM9FR	165687	05 00 04 04	8.31 kg	1	pc(s)	89
V3NC5HX	164031	05 00 04 02	3.44 kg	1	pc(s)	67
V3RQASE	163744	05 00 04 13	1.09 kg	1	pc(s)	103
V3WJMY	163676	05 00 04 04	3.65 kg	1	pc(s)	87
V4RJ7A2	165526	05 00 04 04	5.76 kg	1	pc(s)	88
V4YPRGE	165243	05 00 04 02	1.14 kg	1	pc(s)	65
V5SVXPH	164727	05 00 04 04	6.33 kg	1	pc(s)	87
V5VN56Z	165465	05 00 04 04	4.81 kg	1	pc(s)	88
V6VE249	164185	05 00 04 02	10 kg	1	pc(s)	67
V7GN8WU	162389	05 00 04 02	4.62 kg	1	pc(s)	67
V8D4AQ2	163485	05 00 04 02	6.04 kg	1	pc(s)	66
V8MCNWM	165441	05 00 04 04	10 kg	1	pc(s)	88
V8PPJEF	165649	05 00 04 04	10 kg	1	pc(s)	89
V8VF7CP	165458	05 00 04 04	4.66 kg	1	pc(s)	88
V9JF26K	163294	05 00 04 02	2.09 kg	1	pc(s)	65
V11E77B	163515	05 00 04 02	5.52 kg	1	pc(s)	66
V18JQH	163546	05 00 04 02	1.91 kg	1	pc(s)	66
V27E2GP	163980	05 00 04 02	7.89 kg	1	pc(s)	67
V43FCV8	165571	05 00 04 04	10 kg	1	pc(s)	89
V76D5TH	164178	05 00 04 02	10 kg	1	pc(s)	67
V93UVAP	164024	05 00 04 02	10 kg	1	pc(s)	67
V162LDM	162655	05 00 04 12	1.38 kg	1	pc(s)	100
V291ZZT	163997	05 00 04 02	9.39 kg	1	pc(s)	67
V797FE6	163188	05 00 04 02	6.65 kg	1	pc(s)	65
V7265NS	163355	05 00 04 02	1.04 kg	1	pc(s)	65
V8115WA	163508	05 00 04 02	4.60 kg	1	pc(s)	66
VA3926U	165403	05 00 04 04	6.81 kg	1	pc(s)	87
VAB3PJV	165410	05 00 04 04	7.80 kg	1	pc(s)	87
VABRSSE	164048	05 00 04 02	6.65 kg	1	pc(s)	67
VACNLP8	165540	05 00 04 04	7.51 kg	1	pc(s)	88
VAM7M6H	165267	05 00 04 02	4.25 kg	1	pc(s)	65
VB1DETL	165632	05 00 04 04	1.53 kg	1	pc(s)	89
VB53TC9	163270	05 00 04 02	8.23 kg	1	pc(s)	65
VCEY1U6	165397	05 00 04 04	5.33 kg	1	pc(s)	87
VD28FAD	165434	05 00 04 04	3.94 kg	1	pc(s)	87
VDXTBGF	164192	05 00 04 02	10 kg	1	pc(s)	67
VDZ2VDX	163843	05 00 04 13	1.38 kg	1	pc(s)	103
VE5E8FZ	165557	05 00 04 04	10 kg	1	pc(s)	89
VE5K3HM	162679	05 00 04 12	1.53 kg	1	pc(s)	100
VE5MT89	163522	05 00 04 02	1.24 kg	1	pc(s)	66
VE9HQHJ	165496	05 00 04 04	7.91 kg	1	pc(s)	88
VEH4JQY	163850	05 00 04 12	10 kg	1	pc(s)	100
VF33XR2	165564	05 00 04 04	10 kg	1	pc(s)	89
VFV1Z7K	163331	05 00 04 02	10 kg	1	pc(s)	65
VFZ17TJ	165663	05 00 04 04	10 kg	1	pc(s)	89
VG3V6T2	165298	05 00 04 02	7.32 kg	1	pc(s)	66
VG4GXHQ	165618	05 00 04 04	10 kg	1	pc(s)	89
VGCMAA5	162518	05 00 04 02	10 kg	1	pc(s)	67

Variant No.	GTIN*	PG	Weight	PU	SU	Page
VGHVBP5	360389	05 00 04 05	1.12 kg	1	pc(s)	64
VGJD2QX	165373	05 00 04 04	10 kg	1	pc(s)	87
VGM214B	164017	05 00 04 02	2.01 kg	1	pc(s)	67
VGUVRRG	164000	05 00 04 02	1.67 kg	1	pc(s)	67
VH8QTCZ	163775	05 00 04 14	5.43 kg	1	pc(s)	107
VH95BZZ	165274	05 00 04 02	3.54 kg	1	pc(s)	66
VHBWUNH	163645	05 00 04 04	7.86 kg	1	pc(s)	87
VHV1NKR	164147	05 00 04 02	10 kg	1	pc(s)	67
VJ7VGZD	163553	05 00 04 02	2.67 kg	1	pc(s)	66
VJ13VWW	162136	05 00 04 02	2.27 kg	1	pc(s)	65
VKB2Q6J	163829	05 00 04 14	5.58 kg	1	pc(s)	107
VKVBG8W	360136	05 00 04 05	1.51 kg	1	pc(s)	64
VKZLVU3	165502	05 00 04 04	7.90 kg	1	pc(s)	88
VLB2F3G	163607	05 00 04 02	3.83 kg	1	pc(s)	66
VLL6JWS	163348	05 00 04 02	6.08 kg	1	pc(s)	65
VM2J7S3	165281	05 00 04 02	5.05 kg	1	pc(s)	66
VMBDCM1	165519	05 00 04 04	5.09 kg	1	pc(s)	88
VMLM2BZ	165489	05 00 04 04	6.44 kg	1	pc(s)	88
VMRSJWD	163805	05 00 04 12	1.10 kg	1	pc(s)	100
VMZDL8N	165625	05 00 04 04	10 kg	1	pc(s)	89
VN35H5D	163560	05 00 04 02	2.19 kg	1	pc(s)	66
VN63A91	163812	05 00 04 14	5.40 kg	1	pc(s)	107
VNC159W	163539	05 00 04 02	1.56 kg	1	pc(s)	66
VP6YV4T	162686	05 00 04 14	6.13 kg	1	pc(s)	107
VPH98CT	165472	05 00 04 04	5.75 kg	1	pc(s)	88
VPHZV2	163379	05 00 04 02	1.55 kg	1	pc(s)	65
VPZBBSL	163317	05 00 04 02	4.03 kg	1	pc(s)	65
VQ7PF5A	164154	05 00 04 02	10 kg	1	pc(s)	67
VQKTK4T	163768	05 00 04 14	5.23 kg	1	pc(s)	107
VQY44GL	165656	05 00 04 04	4.51 kg	1	pc(s)	89
VQYP8B2	163195	05 00 04 04	7.15 kg	1	pc(s)	87
VRAB9WB	165533	05 00 04 04	6.72 kg	1	pc(s)	88
VRDSN66	163669	05 00 04 04	3.29 kg	1	pc(s)	87
VRJG23Y	163300	05 00 04 02	2.93 kg	1	pc(s)	65
VRP32FL	165595	05 00 04 04	10 kg	1	pc(s)	89
VSB29AH	162662	05 00 04 13	805 g	1	pc(s)	104
VSHDQZB	163836	05 00 04 13	1.71 kg	1	pc(s)	103
VSUN6NV	163782	05 00 04 13	1.56 kg	1	pc(s)	103
VSU71K4	163287	05 00 04 02	982 g	1	pc(s)	65
VTCS2XV	163584	05 00 04 02	2.83 kg	1	pc(s)	66
VTJKEZU	165250	05 00 04 02	2.99 kg	1	pc(s)	65
VTSY9XH	163621	05 00 04 04	6.40 kg	1	pc(s)	87
VU8P6LE	165380	05 00 04 04	4.38 kg	1	pc(s)	87
VUKMT58	163799	05 00 04 13	1.25 kg	1	pc(s)	103
VVL7AKP	164130	05 00 04 02	10 kg	1	pc(s)	67
VVXDACJ	279032	05 00 04 03	1.94 kg	1	pc(s)	64
VWBDMP5	165670	05 00 04 04	7.12 kg	1	pc(s)	89
VZC3FST	163324	05 00 04 02	5.47 kg	1	pc(s)	65
VZKQZB5	164161	05 00 04 02	2.28 kg	1	pc(s)	67
VZL6TGH	163362	05 00 04 02	1.31 kg	1	pc(s)	65
VZPW9LG	163751	05 00 04 12	675 g	1	pc(s)	100

Type	Part No.	Page	Type	Part No.	Page	Type	Part No.	Page	Type	Part No./Variant No.	Page
A STK	766 888	166	AS SCHR M12 M12 40	705 504	61	DSRT QD	782 000	138	EKV UKQ UKH70 4000AL	752 041	95
AB 32 46 RW K L...	700 099	151	AS SCHR M16 55 M12	705 510	61	DSRT QD II	782 002	138	EKV1+0 35 ... (Alu) ...	VGHVBP5	64
AD EP TI M10	745 022	104	AS SCHR M16 65	750 500	61	DSRT SR D8 L20	782 098	137	EKV1+0 50 ... (Alu) ...	VKVBG8W	64
AD ES SQ SK	765 001	81	AS SCHW M12	336 020	60	EAB RN 16 FS	790 150	78	EKV1+0 70 ... (Alu) ...	VVXDACJ	64
AD ES SQ SQL	765 006	83	AS SCHW M12 25	705 501	60	EAB RN 16 SKN	790 160	78	EKV1+0 16 ...	V4YPRGE	65
AD FB18 7 STK SN7007	766 321	177	AS SCHW M16	336 025	60	EAP 2 25 KKH HG	728 501	63	EKV1+0 25 ...	VS7Y1K4	65
AD HV STK SQ	766 313	166	AS SCHW M16 30	755 501	60	EAP 2 25 MA US OL	728 502	63	EKV1+0 35 ...	V9JF26K	65
AD M12 STK 30 350	766 352	177	ASPS 110 132 16.7 L	767 565	39	EAP 25 SIT US OL	728 503	63	EKV1+0 50 ...	VRJG23Y	65
AD PHE4 STK 410	783 930	177	ASPS 110 420 L	767 571	39	EAPA 3 KFP 20 B13	728 522	62	EKV1+0 70 ...	VPZBBSL	65
AD ZK 25 200	766 055	177	ASPS 110 420 S	767 572	39	EAPA 3 KFP 20 KKH	728 620	62	EKV1+0 95 ...	VZC3FST	65
AD ZK 3M 170	766 059	177	ASPS 110 420 S L	767 573	39	EAPA 3 KFP 25 B13	728 526	62	EKV1+0 120 ...	V797FE6	65
AD ZK STK 30 360	766 359	177	AT 50 30	785 442	162	EAPA 3 KFP 25 KKH	728 625	62	EKV1+0 150 ...	VB53TC9	65
AH ISMTC	766 038	168	AT IHS NS	785 490	123	EAPA 3 RN 16 B13	728 506	62	EKV1+1 16 ...	VE5E8FZ	89
AK 25 ESH STK SN7361	766 372	18	AT SPN II	766 543	44	EAPA 3 RN 16 EAB	728 516	62	EKV1+1 25 ...	VF33XR2	89
AK 36 SK STK 330	766 364	170	ATK 120 ..M NS	785 468	124	EAS EK FM 12	775 621	78	EKV1+1 35 ...	V43FCV8	89
AK 36 SQ STK 360	766 365	170	ATK 120 25M NS	785 467	124	EAS EK FM 16	775 631	78	EKV1+1 50 ...	V2KWXUL	89
AK AH ZK ISMTC	766 049	171	ATK 135 ..M NS	785 466	124	EAS EK FS 12	775 626	78	EKV1+1 70 ...	VRP32FL	89
AK SK24 SK12	763 712	19	ATK 135 50M NS	785 465	124	EAS EK FS 16	775 636	78	EKV1+1 95 ...	V2WPPYVF	89
APA B	785 788	129	ATN 140 ..M NS	785 472	124	EB 9V AL	767 713	168	EKV1+1 120 ...	VG4GXHQ	89
APA KP	785 789	129	ATN 140 10M NS	785 471	124	EB 9V LI	767 712	168	EKV1+1 16 ... (Uni) ...	VMZDL8N	89
APC 48 50	785 755	129	BEV 2XUKH 70 8500AL	752 192	96	EK FL30 SKN	792 030	78	EKV1+1 25 ... (Uni) ...	VB1DETL	89
APC 52 54	785 756	129	BEV BM HZ BDW K	751 193	95	EK FL40 SKN	792 190	78	EKV1+1 35 ... (Uni) ...	V8PPJEF	89
APC 56 58	785 757	129	BEV BM HZ BDW R	751 197	96	EFP 16 RN M12	790 250	60	EKV1+1 50 ... (Uni) ...	VQY44GL	89
APC 60 62	785 758	129	BEV MF LTE	751 192	96	EFP 16 RN M12 35 SSM	790 251	60	EKV1+1 70 ... (Uni) ...	VFZ17TJ	89
APC 64 66	785 759	129	BEV MF SE K	751 191	95	EFP 16 RN M16	790 260	60	EKV1+1 95 ... (Uni) ...	VWBDMP5	89
APG 8	785 796	130	BEV MF SE R	751 196	96	EFP 16 RN M16 45 SSM	790 261	60	EKV2 50 KKH 600 1800	751 150	95
APG 9	785 797	130	BEV OL NPF K	750 210	90	EG 00 4A VI	745 922	101	EKV2+0 16 G ...	V7265NS	65
APG 10	785 798	130	BEV OL NPF PKW K	750 196	90	EG SK STK 400	745 415	110	EKV2+0 25 G ...	VZL6TGH	65
APG 11	785 799	130	BEV OL NPF PKW R	750 216	90	EG SQ STK 400	745 414	110	EKV2+0 35 G ...	VPHPVZV	65
APG 12	785 800	130	BEV OL NPF R	750 218	90	EG TI EKV	745 400	106	EKV2+0 50 G ...	VJ13VWW	65
APG 8 L	785 808	130	BEV OL PF K	750 211	91	EHH BEV OL	740 124	96	EKV2+0 70 G ...	VTJKEZU	65
APG 9 L	785 809	130	BEV OL PF PKW K	750 200	92	EK FL20 FS	745 502	105	EKV2+0 95 G ...	VAM7M6H	65
APG 10 L	785 810	130	BEV OL PF PKW R	750 217	92	EK I FL20 DGF	745 602	105	EKV2+0 120 G ...	VFV1Z7K	65
APG 11 L	785 811	130	BEV OL PF R	750 219	91	EK SN7089	745 510	101	EKV2+0 150 G ...	VLL6JWS	65
APG 12 L	785 812	130	BEV OL PF V2 K	750 214	91	EKS 50 BEV 12M	751 120	96	EKV3 16TI EK ...	VS29AH	104
APHO	785 760	131	BEV OL PF V2 R	750 221	91	EKS 50 BEV 13M	751 130	96	EKV3 16TI HK ...	V3RQASE	103
APJ 46	785 769	129	BEV SVUL	750 213	93	EKS 50 BEV 14M	751 140	96	EKV3 16VI EK ...	VZPW9LG	100
APJ 48	785 770	129	BEV UKH K 70 8500AL	752 191	95	EKS 50 BEV 4M	751 040	96	EKV3 25BS ZK ...	VQKTK4T	107
APJ 50	785 771	129	BEV UKH K 70 12000AL	752 193	95	EKS 50 BEV 8.5M	751 085	96	EKV3 25IS ZK ...	VH8QTCZ	107
APJ 52	785 772	129	BEV UKH R 70 8500AL	752 196	96	EKS B10.5 70 4000AL	752 040	96	EKV3 25TI DG ...	VSUN6NV	103
APJ 54	785 773	129	BEV UKH R 70 12000AL	752 197	96	EKS B10.5 70 8500AL	752 085	96	EKV3 25TI HK ...	VUKMT58	103
APJ 56	785 774	129	BEV US OL ST	750 212	92	EKS B10.5 70 12000AL	752 120	96	EKV3 25VI DG ...	V162LDM	100
APJ 58	785 775	129	BEV WHA ZVA	750 215	93	EKS TI 2F KVS SBK	745 500	102	EKV3 25VI EK ...	VMR5JWD	100
APS 12C FS	785 749	133	BS EP NH1 3 TI	745 506	105	EKS TI KVS SBK	766 302	102	EKV3 35BS ZK ...	VN63A91	107
APS 12C SC	785 747	133	DGF EKV VI	745 921	101	EKS VI 2F KVS KK	745 903	99	EKV3 35IS ZK ...	VKB2Q6J	107
APS CL1 MEHA	785 721	134	DP 40 40 B13 AL	525 001	59	EKS VI 2F KVS SBK	745 901	99	EKV3 35TI DG ...	VSHDQZB	103
APS CL2 FS	785 748	133	DP 50 50 B17 AL	525 002	59	EKV FD K 70 8500AL	752 086	94	EKV3 35TI HK ...	VDZ2VDX	103
APS CL2 MAHA	785 722	134	DR PAG	759 798	168	EKV FD K 70 12000AL	752 126	94	EKV3 35VI DG ...	VE5K3HM	100
APS CL2 SC	785 746	133	DR PS PHE3	767 779	168	EKV FD K H70 12000AL	752 121	94	EKV3 35VI EK ...	VEH4JYQ	100
APS HO	785 754	131	DSRT DD CPS AACA	782 031	136	EKV FD R 70 8500AL	752 087	94	EKV3 50IS ZK ...	VP6YV4T	107
APS T 12C FS	785 765	133	DSRT DD CPS BACA	782 030	136	EKV FD R 70 12000AL	752 127	94	EKV3 NH00 TI ...	V1RC3P2	103
APS T 12C SC	785 762	133	DSRT DD FS AAAA	782 051	136	EKV FD R H70 12000AL	752 122	94	EKV3+0 16 G ...	VE5MT89	66
APS T 20C FS	785 766	133	DSRT DD FS BAAA	782 050	136	EKV K 50 8500	751 086	94	EKV3+0 25 G ...	VNC1S9W	66
APS T 20C SC	785 763	133	DSRT DD PS AACA	782 041	136	EKV K 50 12000	751 126	94	EKV3+0 35 G ...	V18JQHQ	66
APS T CL2 FS	785 764	133	DSRT DD PS BACA	782 040	136	EKV K H 50 12000	751 121	94	EKV3+0 50 G ...	VJ7VGZD	66
APS T CL2 SC	785 761	133	DSRT FC D8	782 099	137	EKV LK 50 4000	750 042	95	EKV3+0 70 G ...	VH95BZZ	66
APT 46	785 779	129	DSRT FS 10 1.5	782 081	137	EKV LK UKH 70 4000AL	752 042	95	EKV3+0 95 G ...	VM2J7S3	66
APT 48	785 780	129	DSRT FS 12 1.5	782 085	137	EKV R 50 8500	751 087	94	EKV3+0 120 G ...	V8D4AQ2	66
APT 50	785 781	129	DSRT FS 15 1.5	782 091	137	EKV R 50 12000	751 127	94	EKV3+0 150 G ...	VG3V6T2	66
APT 52	785 782	129	DSRT FS 8 1.5	782 077	137	EKV R H 50 12000	751 122	94	EKV3+0 50 R ...	VN35H5D	66
APT 54	785 783	129	DSRT LWL 0.75	782 020	138	EKV ÜGK MB	745 107	108	EKV3+0 70 R ...	VTC52XV	66
APT 56	785 784	129	DSRT LWL 2.00	782 022	138	EKV ÜGK MB S	745 105	108	EKV3+0 95 R ...	VLB2F3G	66
APT 58	785 785	129	DSRT LWL 4.00	782 024	138	EKV ÜGK MB SN7354	745 115	109	EKV3+0 120 R ...	V8115WA	66
AR STK	766 889	166	DSRT LWL 8.00	782 028	138	EKV ÜGK MB SN7724	745 121	109	EKV3+0 150 R ...	V11E77B	66
ARS 65 40	785 443	162	DSRT PS	782 060	137	EKV UK 50 4000	750 041	95	EKV3+1 16 G ...	VGJD2QX	87
AS SCHR M12 55	705 500	61									

Type	Part No./Variant No.	Page	Type	Part No.	Page	Type	Part No.	Page	Type	Part No.	Page
EKV3+1 25 G RDSN66	87	ES SQ STK 2000	761 004	81	H STK 43 800	766 120	175	IS ZK STK HS 670	766 369	172
EKV3+1 35 G V3WJMY	87	ES SQL ALSTK 1035	769 516	171	HISC 1600	785 310	121	ISMTC N 36 ZK 10600	766 037	173
EKV3+1 50 G VU8P6LE	87	ES SQL STK 43 1045	766 074	171	HK 8 NS	785 648	125	ISN 123 SQ STK 2500	766 332	11
EKV3+1 70 G VCEY1U6	87	ES YM2 16	716 001	68	HKGH ESH MEHA	786 799	143	ISN 25 STK 900SN7360	766 371	18
EKV3+1 95 G VA3926U	87	ES YM2 25	725 001	68	HSA 194 110 420			ISN 36 SK STK 1000	766 111	11
EKV3+1 120 G VAB3PJV	87	ES YM2 35	735 001	68	SN7737	767 539	40	ISN 36 SQ STK 1000	766 310	11
EKV3+1 150 G V1KPXFR	87	ES YM2 50	750 001	68	HSA194 110 420 16.7	767 542	40	ISN 36 STK 30 1280	766 367	173
EKV3+1 16 G ... (Uni)...	V8MCNWM	88	ES YM2 70	770 001	68	HSA194 110 420 STK	767 541	40	ISN 36 STK 930SN7688	766 362	173
EKV3+1 25 G ... (Uni)...	V8VF7CP	88	ES YM2 95	795 001	68	HSA205 U 1 420 STK	767 552	41	ISO M12 STK 30SN7563	766 116	174
EKV3+1 35 G ... (Uni)...	V5VN56Z	88	ES YM2 120	712 001	68	HSA205 U 1 420			ISP 36 PVC A1...	763 211	113
EKV3+1 50 G ... (Uni)...	VPH98CT	88	ES YM2 150	715 001	68	SN7608	767 547	41	ISP 36 PVC A2...	763 221	113
EKV3+1 70 G ... (Uni)...	VMLM2BZ	88	ESE E27 KBI M10	745 203	105	HV 3HH	700 015	167	ISP 36 PVC A3...	763 231	113
EKV3+1 95 G ... (Uni)...	VE9HQHJ	88	ESE E27 TI M10	745 201	105	HV 3HH ET	700 005	167	ISP 36 PVC A4...	763 241	113
EKV3+1 120 G ... (Uni)...	VK2LVU3	88	ESE E33 KBI M10	745 204	105	HV 3HH SZ	700 014	167	ISU STK STK 30SN7564	766 117	174
EKV3+1 50 R VD28FAD	87	ESE E33 TI M10	745 202	105	HV 3HH SZ ET	700 004	167	ISV 36 STK 30 910	766 356	175
EKV3+1 70 R VQYP8B2	87	ESH U 1000 S SB	785 708	132	HV ALSTK 1035	769 517	176	ISV 36 STK 30 1280	766 366	175
EKV3+1 95 R V5SVXPH	87	ESH U 1000 S SO	785 707	132	HV ALSTK AK RW 1035	769 519	176	ISV SK12 1060	763 711	19
EKV3+1 120 R VTSY9XH	87	ESH U 1000 S SR	785 709	132	HV ALSTK RW 1035	769 518	176	IT M12 STK 30 1150	766 115	174
EKV3+1 150 R VHBWUNH	87	ESH U 1000 S SW	785 706	132	HV EKV ES30	700 000	167	IT PHE4 STK 760	783 920	174
EKV3+1 50 R ... (Uni)...	VMBDCM1	88	ESH U 1000 S SY	785 705	132	HV EKV ES30 1500	700 003	167	IT PHE4 STK 1210	783 925	174
EKV3+1 70 R ... (Uni)...	V4RJ7A2	88	ESP HVS 1500	799 006	76	HV EKV ES40	700 002	167	IT ZK30 STK 30 360	766 358	174
EKV3+1 95 R ... (Uni)...	VRAB9WB	88	ESS 3P M10 FM	799 019	75	HV P ST D24	700 006	167	KFP 20 M10	754 205	57
EKV3+1 120 R ... (Uni)...	VACNLP8	88	EST ES 1500	769 505	83	HV P ST D30	700 007	167	KFP 20 M12	754 200	57
EKV4u0 16 G VGUVRRG	67	EST KS SQL 1500	769 503	83	HV P ST D40 45	700 008	167	KFP 20 M12 35 SSM	754 235	57
EKV4u0 25 G VGM214B	67	EST SK STK 920	761 070	81	HV STK 30 710	766 335	175	KFP 20 M12 45		
EKV4u0 35 G V93UVAP	67	EST SQ STK 920	761 075	81	HV STK 43 1045	766 076	175	SN7078	754 238	57
EKV4u0 50 G V3NC SHX	67	EST SQL RW 4855 TA	769 515	85	HV STK 43 1280	766 466	175	KFP 20 M16	754 600	57
EKV4u0 70 G V7GN8WU	67	EST SQL RW 4915 TA	769 506	85	HV STK 43 2350	766 073	175	KFP 20 M16 45 SSM	754 645	57
EKV4u0 95 G VABRSSE	67	EST ZS 1500	769 504	83	HV STK 43 910	766 456	175	KFP 20 S AL 12	706 300	57
EKV4u0 120 G V27E2GP	67	ESTC PSK 5000 SN7249	769 511	72	HV STK 43 975	766 077	175	KFP 20 W45 M12	706 200	58
EKV4u0 150 G V291ZZT	67	ESTC SQ STK SN7562	769 304	81	HV STK RW 43 975	766 079	176	KFP 20 W45 M12		
EKV5+0 16 G VQ7PF5A	67	ESTC SQL 4000	769 400	82	HV STK RW 43 1045	766 078	176	35SSM	706 235	58
EKV5+0 25 G VZKQZB5	67	ESTC SQL 5000	769 500	82	HVTC STK 4100 SN7359	766 469	18	KFP 20 W45 M16	706 600	58
EKV5+0 35 G V76D5TH	67	ESTC SQL H RW 5000	769 508	84	IHS 0 M 9 NS	785 493	123	KFP 20 W45 M16		
EKV5+0 50 G V6VE249	67	ESTC SQL RW 3500	769 352	84	IHS 0 M 10 NS	785 494	123	45SSM	706 645	58
EKV5+0 70 G VDXTBGF	67	ESTC SQL RW 5000	769 502	84	IHS 00 M 9 NS	785 491	123	KFP 20 W45M12		
EKV5+0 95 G VGCMAA5	67	ESTC SQL STK 3000	769 300	82	IHS 00 M 10 NS	785 492	123	SN7024	706 239	58
EKV5+0 120 G VVL7AKP	67	EV EH 1725 EK	758 015	154	IHS 00 RC 9 NS	785 495	123	KFP 20 W90 M12	707 200	59
EKV5+0 150 G VHV1NKR	67	EV EHB 1600 SN7114	758 028	155	IHS 00 RC 10 NS	785 496	123	KFP 20 W90 M12		
EL 16CU EZ KS8.5	758 216	157	EV EHB STK 1600	758 095	157	IMG SAN 1M ..M	785 458	125	35SSM	707 235	59
EL 16CU KS12.5 8.5	758 116	157	EV TES 465 EK	758 020	153	IMG SAN 1M 10M	785 459	125	KFP 20 W90 M16	707 600	59
EL 25CU KS12.5 8.5	758 125	157	EV TES 465 EZ	758 021	153	IMG SI ..M NS	785 456	124	KFP 20 W90 M16		
EL 35CU KS12.5 8.5	758 135	157	EV TES 465 KS10	758 022	153	IMG SI 1M NS	785 455	124	45SSM	707 645	59
EL M8 G PHE	766 924	164	EV TES 465 SN7215	758 036	156	IMG SI 10M NS	785 457	124	KFP 25 M12	755 200	57
EL M8 H PHE	766 923	164	EV TES STK 1500	758 085	156	IS 123 SK STK 2000	766 122	11	KFP 25 M12 25 SSM	755 225	57
EL M8 MAG PHE PHV	766 915	164	EV TES STK 1500 KS	758 025	155	IS 123 SQ STK 2000	766 322	11	KFP 25 M12 35 SKM	755 627	58
EL M8 S PHE PHV	766 925	164	EV TS 1470 SN7685	758 031	155	IS 25 ZK 2885	766 048	173	KFP 25 M12 45 SSM	755 245	57
EL M8 SZ PHE PHV	766 913	164	EV TS 2000 EK	758 001	154	IS 25 ZK RK 3160	766 340	20	KFP 25 M16	755 600	57
EL M8 V PHE PHV	766 927	164	EV TS 2000 EZ	758 003	154	IS 36 SK 1000	766 001	10	KFP 25 M16 25	755 636	58
EP NH00 TI M10	745 302	104	EV TS STK 1470	758 075	156	IS 36 SK 1500	766 002	10	KFP 25 M16 25 SKM	755 626	58
EP NH00 VI TA	745 905	101	FD 60 MS SN7271	785 225	121	IS 36 SK STK 1000	766 100	11	KFP 25 M16 45 SKM	755 646	58
EP NH1 3 TI GL M10	745 017	104	FEK 4 15 TS FSQ	784 755	74	IS 36 SQ 1000	766 311	10	KFP 25 M16 45 SSM	755 645	57
EP NH1 3 TI M10	745 018	104	FEK4 15 TS FSQ AB29	784 756	74	IS 36 SQ 1500	766 315	10	KFP 25 RL 10	725 010	58
EP NH1 3 VI TA	745 910	101	FR A10 V2A	524 910	59	IS 36 SQ STK 1000	766 301	11	KFP 25 RL 12	725 012	58
EP NH4A TI M10	745 016	104	FR A12 V2A	524 912	59	IS 36 STK 30 1280	766 363	173	KFP 25 RL 14	725 014	58
EP NH4A VI TA	745 915	101	FR A16 V2A	524 913	59	IS 72.5 SQ SN7743	766 312	10	KFP 25 RL 16	725 016	58
ERO BSP ASSM10			FRS ZK MS	785 940	119	IS M12 AK 635	766 328	172	KFP 25 RL 18	725 018	58
1000 STTZN	644 000	75	FSG PHE	767 776	168	IS M12 STK 640	766 331	172	KFP 25 RL 20	725 020	58
ES 3P FL ER	799 009	75	FSG PHG2 PHV	767 777	168	IS M12 STK 30 720	766 072	174	KFP 25 S AL 12	756 300	57
ES SK 1000	761 010	80	FWD 35 P NS	785 592	121	IS M12 STK 30 1060	766 075	174	KFP 25 W45 M12	756 200	58
ES SK 1500	761 015	80	GL 3.5V 0.2A E10	766 605	168	IS PHE4 STK 700	783 900	172	KFP 25 W45 M12		
ES SK STK 1000	761 001	81	GR PAG	759 799	168	IS PHE4 STK 770	783 905	172	45SSM	756 245	58
ES SK STK 2000	761 003	81	H AB 32 46 K	700 098	151	IS PHE4 STK 1110	783 906	172	KFP 25 W45 M16	756 600	58
ES SQ 1000	761 011	80	H STK 43 500	766 520	175	IS SK12 HK 1720	763 710	19	KFP 25 W45 M16		
ES SQ 1500	761 016	80				IS ZK STK 670	766 368	172	45SSM	756 645	58
ES SQ STK 1000	761 002	81							KFP 25 W90 M12	757 200	59

Type	Part No.	Page	Type	Part No.	Page	Type	Part No.	Page	Type	Part No.	Page
KFP 25 W90 M12			PHE 15 16.7 6T TA	766 617	36	PHE4 60 132 S	783 280	27	RP 250 115 20	766 057	171
45SSM	757 245	59	PHE 15 16.7 BEL STK	767 413	35	PHE4 220 420 S	783 290	27	RSI 32	785 213	121
KFP 25 W90 M16	757 600	59	PHE 3 20 S FU 1P	767 416	34	PHE4 110 132 S 16.7 50			RSI 34	785 214	121
KFP 25 W90 M16			PHE 6 20 S 16.7 1P	767 415	35		783 460	27	RSI 35	785 215	121
45SSM	757 645	59	PHE3 3 S	767 703	29	PHE4 20 36 S 60	783 342	26	RSI 38	785 216	121
KK 35 NS	785 647	125	PHE3 3.3 S SN7130	767 798	29	PHE4 3 10 S 60	783 332	26	RSI 45	785 217	121
KK 56 41 17 EK HK	745 953	160	PHE3 6 S	767 706	29	PHE4 3 10 S ZK	783 141	26	RSI 51	785 218	121
KK 56 41 17 EK VI TI	745 952	160	PHE3 6.6 S SN7101	767 707	29	PHE4 3 S ZK	783 103	26	RSI 58	785 219	121
KK M8 0 24 SK 10	745 508	105	PHE3 10 S	767 710	29	PHE4 6 S ZK	783 106	26	RST 36 1000	766 040	14
KK TA 0 24 SK10	745 503	101	PHE3 11 S SN7116	767 719	29	PHE4 20 S ZK	783 120	26	RST 36 1500	766 041	14
KKH 20 D SK	772 330	70	PHE3 20 S	767 720	29	PHE4 30 S ZK	783 130	26	RST 36 2000	766 042	14
KKH 20 D SQ	772 331	70	PHE3 22 S SN7128	767 756	29	PHE4 6 20 S 16.7	783 420	26	S 100 ZK MS	785 329	121
KKH 20 FS	772 312	77	PHE3 30 S	767 730	29	PHE4 6 20 S 60	783 335	26	S60 PS PHE 285	767 760	169
KKH 20 HG	772 313	77	PHE3 3 10 S	767 711	29	PHE4 6 20 S ZK	783 151	26	S61 PS PHE 435	767 761	169
KKH 20 SK	772 310	69	PHE3 6 20 S	767 721	29	PHE4 U 2 20 S	783 520	25	S62 PS PHE 620	767 762	169
KKH 20 SQ	772 311	69	PHE3 10 30 S	767 731	29	PHE4 U 3 30 S	783 530	25	S63 PS PHE 780	767 763	169
KKH 20 SQL	772 314	73	PHE3 3 S ZK	767 903	30	PHE4 U 3.3 33 S	783 533	28	S63 PS PHE 8CK	767 768	169
KKH 25 D SK	772 340	70	PHE3 6 S ZK	767 906	30	PHE4 U 6 36 S	783 536	25	S64 PS PHE 880	767 764	169
KKH 25 D SQ	772 341	70	PHE3 10 S ZK	767 910	30	PHE4 U 6.6 11 S	783 511	28	S65 M PS PHE 905	767 767	169
KKH 25 FS	772 322	77	PHE3 20 S ZK	767 920	30	PHE4 U 3 36 S 60	783 395	26	S66 PS PHE 880	767 771	169
KKH 25 HG	772 323	77	PHE3 25 S 50 1P	767 125	29	PHE4 U 6 20 S 16.7 50	783 430	26	S66PS PHE880 C SN7771		
KKH 25 SK	772 320	69	PHE3 30 S ZK	767 930	30	PHEG1 FD M SN7223	767 614	42		769 701	169
KKH 25 SQ	772 321	69	PHE3 33 S SN7129	767 757	29	PHEG1 FD P 3	767 610	42	SA KLFP SK	795 214	98
KKH 25 SQL	772 324	73	PHE3 3 10 S ZK	767 941	30	PHEG1 S P SN7240	767 636	43	SA KLFP SQ	795 213	98
KKL 127 28 12	766 995	159	PHE3 6 20 S ZK	767 951	30	PHEG1.S P SN7401	767 666	42	SAG DCA A LRM	767 112	49
KKL 92 28 12	766 994	159	PHE3 10 30 S ZK	767 961	30	PHEG2 P SN7194	767 637	43	SAG DCA P HR GA	767 101	48
KKL DCA	767 107	160	PHE3 6 20 SL	767 740	30	PHEG2 P SN7259	767 645	43	SAG DCA P LRM GA	767 102	48
KKL EKV VI KVS	745 902	160	PHE3 10 30 SL	767 750	30	PHEG2 P SN7346	767 639	43	SAK PFE KN	792 450	79
KKL EKV ÜGK MB	745 106	108	PHE3 6 20 SL ZK	767 940	30	PHEG2 P SN7407	767 640	43	SAK PFE KN AB29	792 451	79
KKL PHE3	767 997	159	PHE3 10 30 SL ZK	767 950	30	PHEG2 P SN7552	767 647	43	SAK PFE RA	792 453	79
KKL PHE3 60 110	766 998	159	PHE3 PK10 30 L SB ZK	767 932	31	PHEG2.P SN7517	767 671	43	SAK PFE RA AB29	792 454	79
KKL PHE3 L	767 999	159	PHE3 PK6 20 L SB ZK	767 922	31	PHG2 6	766 706	37	SB ESH U 1000	785 739	132
KKL PK PHE3 L	766 036	159	PHE3 PK6 20 S SB ZK	767 921	31	PHG2 10	766 710	37	SBKL EKS TI KVS	766 300	159
KKS M8 0 24 SK10	745 509	109	PHE3 U 3 30 S	767 733	29	PHG2 20	766 720	37	SBKL EKS TI KVS 2F	766 298	159
KLFP M12 KSS	795 040	98	PHE3 U 3 30 S ZK	767 960	30	PHSP NS	785 497	123	SBKL EKS VI KVS	745 900	159
KLT 101 30 10	767 996	160	PHE3 U 6 36 S SN7728	767 944	30	PHV1P 6 12	759 706	46	SCH A10.5 V4A	525 910	59
KLT 104 9	767 574	161	PHE3S 20 S ZK	767 724	33	PHV1P 10 20	759 712	46	SCH A13 V4A	525 912	59
KLT 121 25 16	766 601	160	PHE3S2 60 110 S	767 980	33	PHV1P 20 36	759 736	46	SCH A17 V2A	525 916	59
KLT 133 34 10	766 996	160	PHE3S60 110S C			PHV1P U 5 36	759 716	46	SCS 36 1000	763 610	13
KLT 160 17	766 614	161	SN7774	769 712	33	PS DCA HR LRM	767 150	50	SCS 36 1500	763 611	13
KLT 23 16 4	767 500	51	PHE4 3 S	783 003	25	PS PHE 15 16.7	766 619	170	SCS 36 2000	763 612	13
KLT 247 10 22	766 602	160	PHE4 3.3 S	783 033	28	PSK 4 30 SQL	784 201	71	SCS 36 STK 1000	763 100	13
KM AB M10 SN7280	745 021	105	PHE4 6 S	783 006	25	PSK 4 30 SQL EH	784 401	71	SCS 72 1500	763 615	13
KR ESH U 1000	785 738	132	PHE4 6.6 S	783 066	28	PSK 10 32 SQL	784 032	73	SCS 72 2000	763 620	13
KS SG BLS 8	766 105	168	PHE4 10 S	783 010	25	PSK 10 32 SQL SB	784 038	73	SCSN 36 STK 1000	763 111	13
L71 PS PHE 185	767 766	169	PHE4 11 S	783 011	28	PSK 10 65 SQL	784 301	71	SDS 1	923 110	149
LED DIGIK ISO	766 395	16	PHE4 20 S	783 020	25	PSK 10 65 SQL EH	784 501	71	SDS 2	923 117	149
LED HL ESH	785 723	132	PHE4 22 S	783 022	28	PSK 10 85 SQL	784 085	72	SDS 3	923 116	150
LK 4 40 TS SQL	784 352	74	PHE4 30 S	783 030	25	PSK FV 4 30 SN7084	768 029	72	SDS 4	923 118	150
MA DCA HR LRM	767 133	52	PHE4 33 S	783 045	28	PSK FV 4 30 SQL	784 480	72	SDS 5	923 119	150
MA DCA LR LRM	767 136	52	PHE4 1 3 S	783 013	25	PSO M8 PHE	766 916	165	SE E14	785 639	21
MA SDS M12	723 199	150	PHE4 3 10 S	783 231	25	PSO M8 PHE L800	766 960	165	SE E18	785 650	21
MFB APS	785 724	162	PHE4 3.3 11 S	783 233	28	PSO M8 W25 PHE	766 940	165	SE E27 E33	785 640	21
MOMS LORE EUK	799 100	148	PHE4 6 20 S	783 235	25	PSO M8 W45 PHE	766 941	165	SE NHO	785 642	21
MZ 1.5 IEC LR6 AL	766 618	168	PHE4 6.6 22 S	783 243	28	PSO M8 W90 PHE	766 950	166	SE NH00	785 641	21
MZ 1.5V L91 FR6 LI 4	766 611	168	PHE4 10 20 S	783 240	25	PSS DII	745 109	109	SE NH1	785 643	21
NHS AG 00 3 NS	785 645	123	PHE4 10 30 S	783 250	25	PV DCA PC LRM	767 132	51	SE NH2 3	785 644	21
OEK 12 NS	785 649	125	PHE4 20 36 S	783 245	25	PV DCA PC LRM T	767 139	51	SE REG 1TE	785 638	21
PAP 2 M12 SSM B13	728 312	73	PHE4 110 220 S	783 285	27	RBK 25 SQ SN7151	715 314	70	SE REG 2TE	785 652	21
PAP 3 M12 SSM B13 RB728	313	73	PHE4 10 30 S 60	783 345	26	RBK 26 SQ SN7255	715 315	70	SE REG 3TE	785 637	21
PAS EK SQ 16	771 316	70	PHE4 10 30 S ZK	783 161	26	RBK 30 SQ SN7642	715 313	70	SET DIGIK	766 390	16
PAV 3+1 16 ZAK	758 099	156	PHE4 10 30 S ZK	783 110	26	RBK 35 SQ	715 312	70	SKL 95 21 10	767 701	159
PHE 15 16.7 4T TA	766 616	36	PHE4 11 33 S	783 255	28	REB 25055 ZK MS	785 169	121	SKS M10X30 V2A	561 924	59
			PHE4 30 60 S	783 270	27	RED E27 E14 ÜGK MB	745 108	109	SKS M12X25 V2A	561 925	59
			PHE4 60 110 S	783 275	27	RK 230 100 AS25	766 056	171	SKS M12X30 V2A	561 930	59

Type	Part No.	Page	Type	Part No.	Page	Type	Part No.	Page	Type	Part No.	Page
SKS M12X35 V2A	561 935	59	SZ HH W20 1250	765 051	15	UK 30 SQL	773 331	73	WJP O LP M	786 782	142
SKS M16X30 V2A	561 931	59	SZ HH W20 1500	765 052	15	UK K25 FL30 HG	774 251	79	WJP O LP S	786 781	142
SPG DCA IT LRM	767 122	50				UK K25 FL30 SQL	773 251	79	WJP O LP XL	786 784	142
SPN 500B	766 660	44	TFRS MS	785 950	120				WJP O LP XXL	786 785	142
SPN 1000B	766 665	44	TG DCA	767 110	48	VH SC APS	785 753	131	WJP O M	786 752	142
SRH 1180 IS 650 MS	785 119	122	TRS MS	785 100	118	VH SC APS	785 753	134	WJP O S	786 751	142
SSK 36 STK 560	766 164	170	TRS MS V1	785 112	118	VS 500 SPN II	766 542	44	WJP O XL	786 754	142
SSK 36 STK 930SN7689	766 169	170	TRS NS	785 502	117				WJP O XXL	786 755	142
SSK M12	765 005	170				WBN 200 2.5M NS	785 646	124	WJP OC 3XL	786 746	141
SSK SQ	765 009	170	UEK 25 FS	774 034	77	WJP O 3XL	786 756	142	WJP OC L	786 743	141
STB 80 ZK MS	785 159	121	UEK 25 HG	774 234	77	WJP O AP 3XL	786 766	142	WJP OC M	786 742	141
STT 110 15	769 509	161	UEK 25 SKN	774 434	77	WJP O AP L	786 763	142	WJP OC S	786 741	141
STT 180 20	766 039	161	UEK 30 FS	774 130	77	WJP O AP M	786 762	142	WJP OC XL	786 744	141
STT 55 27 30	785 111	161	UEK 30 HG	774 330	77	WJP O AP S	786 761	142	WJP OC XXL	786 745	141
STT 120 30 15	766 704	161	UEK 30 SKN	774 530	77	WJP O AP XL	786 764	142			
SZ HH 1060	765 040	15	UK 25 SK	773 034	70	WJP O AP XXL	786 765	142	ZK55 IS	771 230	107
SZ HH 1250	765 041	15	UK 25 SQ	773 234	70	WJP O H	786 770	141	ZK55 IS BL	771 231	107
SZ HH 1500	765 042	15	UK 25 SQL	773 236	73	WJP O L	786 753	142	ZK85 BS	771 232	107
SZ HH W20 1070	765 050	15	UK 30 SK	773 130	70	WJP O LP 3XL	786 786	142	ZK85 BS BL	771 233	107
			UK 30 SQ	773 330	70	WJP O LP L	786 783	142			

All specifications and recommendations in this catalogue on the possible applications of our products should be regarded as product information and for advisory purposes only and are based on our experience and expertise and are given to the best of our knowledge. We do not accept any liability in this respect. This particularly applies to the different conditions of use which are beyond our control. We recommend to check whether the respective DEHN product is suitable for the intended application. Application, use and processing of our products are beyond our control. Therefore, the product is completely subject to the user's responsibility.

Illustrations are not binding.

We accept no liability for misprints, modifications and errors.

***) GTIN (EAN-Code)**

In the catalogue, you will find the GTIN (EAN code) next to the Part No. For reasons of clarity, only the individual GTIN part is specified. The country and DEHN code (40 13364) must be put in front of this number.

Abbreviations

PG	Product Group
PU	Packing Unit
SU	Sales Unit (Piece, Meter, Kit or Pair)
pc(s)	Piece
m	Meter
Sa	Kit
Pa	Pair

Weight Weight per sales unit

Key Words

Product	Page	Product	Page	Product	Page
Accessory for NS and MS Cleaning Kits	121	Fastening Material	59	Quenching Device QD II	138
Adapter	166 / 177	Fixed Ball Points	57	Reliable protection when working with high-pressure water jets up to 1000 bar	140
Arc Fault Protection System – active	135	Fixed Earthing Points	60	Rigid Ball Head Cap	69, 70, 73, 77
Arc Fault Protection System – passive	128	FRS ZK MS Damp Cleaning Kit	119	RST Rescue Rods	14
Artificial Leather Bag	160	Handle / Extensions	175	Rucksack	162
ASP Non-Contact Voltage Detector Kit	38	HSA 194 High-Voltage Indicator	40	SCS Switching Sticks	13
Barrier and Accessories	151	HSA 205 High-Voltage Indicator	41	Sealing Ring	168
Battery	168	Ice Removal Rod	18	Service and Safety	145
Canvas Bag	161	Insulating Blankets and Matting	124	Sheet Steel Case	159
Clamp for Railway Tracks	79	Insulating Elements	174	Short-Circuiting Bar: Easy online configuration	97
DEHNcap/A Voltage Indicator	49	Insulating Gloves	123	Single-pole PHV I Phase Comparator	46
DEHNcap HR-LRM Test Kit	50	Insulating Mats with Dielectric Strength 50 kV	125	Spare Parts	168
DEHNcap/IT Interface Test Unit	50	Insulating Protective Shutters	111	Storage Devices	167
DEHNcap/PC-LRM Phase Comparator	51	Insulating Stick Kit for Cleaning the Windscreens of Electric Locomotives	20	SZ Fuse Tongs	14
DEHNcap/P Voltage Indicator	48	Insulating Sticks	172	Test Probes	165
DEHNcap Test Adapter	52	Insulating Stick with Crank Handle	19	Test Prods	169
DEHNcare® APG – Protective Gloves	130	IS Insulating Sticks	10	TFRS MS Combined Cleaning Kit	120
DEHNcare® APHO – Protective Hood	131	Key Words	192	TRS MS Dry Cleaning Kit	118
DEHNcare® APJ, APT and APC – Protective Jackets, Protective Trousers and Protective Coats	128	Kits for Railway Applications	90	TRS NS Dry Cleaning Kit	117
DEHNcare® APS – Face Shield	133	Line Clamp	74	Two-pole SPN Voltage Detector	44
DEHNcare® WJP	141	Live Working	116	Universal Clamp	70, 73, 77, 79
DEHNshort – Active Arc Fault Protection System	135	Lock-out Systems	21	VLD Voltage Limiting Devices	149
Design of Phase Comparators	45	MicroΩmeter LoRe EaS	148	Wireless Inspection Camera	16
Design of Voltage Detectors	24	NH Fuse Handle with Sleeve Notes	123 191	Working According to The Five Safety Rules	8
Discharge and Equipotential Bonding Devices	153	Operating Heads	170		
Earth Clamp for Overhead Contact Lines	74	Periodic Testing of Safety Devices at DEHN	145		
Earth Connecting Elements for Railway Applications	79	Phase Connecting Elements for Overhead Lines	71		
Earth Connecting Elements for Switchgear Installations and Overhead Lines	76	Phase Connecting Elements for Railway Applications	74		
Earth Connecting Plates	62	Phase Connecting Elements for Switchgear Installations	69		
Earthing and Short-Circuiting Cables, unequipped	64	Phase Screw Clamp	71-73		
Earthing and Short-Circuiting Device for Street Lighting Systems	108	PHE4 Voltage Detector (British Influenced Voltage Level)	28		
Earthing and Short-Circuiting Devices	54	PHE4 Voltage Detector Nominal Voltage 1 ... 36 kV	25		
Earthing and Short-Circuiting Devices for Crane Conductor Bars	106	PHE4 Voltage Detector Nominal Voltage 30 ... 420 kV	27		
Earthing and Short-Circuiting Devices for Railway Applications	94	PHE/G d.c. Voltage Detector	42		
Earthing and Short-Circuiting Devices (fully insulated) for Low-Voltage Cable Distribution Cabinets	99	PHE III Voltage Detector	29		
Earthing and Short-Circuiting Devices (partly insulated) for Low-Voltage Cable Distribution Cabinets	102	PHE III Voltage Detector Kit	32		
Earthing Handle for Low-Voltage Installations	110	PHE III ZK Indicator with Test Prod	31		
Earthing Kit	75	PHE Voltage Detector	34		
Earthing Spike	76	PHE Voltage Detector Kit	36		
Earthing Sticks for Overhead Lines	82	PHG II Voltage Detector	37		
Earthing Sticks for Railway Applications	84	PHV I Phase Comparator	46		
Earthing Sticks for Switchgear Installations	80	Plastic Bag / Rucksack	162		
EaS Configurator: Easy online configuration	86	Plastic Case	159		
Easy Choice – Storage Bags and Transport Cases	158	Pneumatic glove tester	123		
Electrodes	164	PPE – Personal Protective Equipment	123		
End Fittings	166	Protective Rubber	168		
Equipotential Bonding Devices	156				
ESH U S Safety Helmet for Electricians	132				
Extensions	175				



Surge Protection
Lightning Protection
Safety Equipment
DEHN protects.®

DEHN + SÖHNE
GmbH + Co.KG.

Hans-Dehn-Str. 1
Postfach 1640
92306 Neumarkt
Germany

Phone +49 9181 906 0
Fax +49 9181 906 1100
sales@dehn.de
www.dehn-international.com



For information on our registered trademarks, please visit short link: de.hn/tm.
We reserve the right to make technical changes. We accept no liability for misprints or errors. All images are without obligation.