

The DEHN logo is positioned in the upper right corner of the page, set against a background of a dark, stormy sky with a bright, jagged lightning bolt striking downwards. The logo itself consists of the word "DEHN" in a bold, white, sans-serif font, flanked by two white, stylized arrowheads pointing outwards.

Surge protection in low-voltage switchgear assemblies

White Paper



Contents

IEC 60364-4-44 and
IEC 60364-5-53

- SPD at supply point
- Requirements on protection level
- Requirements on impulse current

Protection against short-circuiting

Effective protective distance of SPDs

Requirements on cable lengths and cross-sections of SPDs

Surge protection in low-voltage switchgear assemblies

White Paper



The publication of the installation standards IEC 60364-4-44 and IEC 60364-5-53 in September 2015 made the use of surge protective devices (SPDs) compulsory. This requirement is no longer just valid for commercial and industrial facilities, but also holds unconditional validity for residential buildings: houses and flats. The surge protective devices are now, as a general rule, to be installed at the supply point of the facility (in the vicinity of the entrance point into the building). This supply point may be the main distribution board (MDB)/low voltage main distribution.

In the MDB/low voltage main distribution, it is obligatory to have an SPD to protect against common-mode interference (active line to ground). In order to protect against lightning current and switching overvoltage, facilities with external lightning protection must have a combined arrester. With regard to the parameters discharge capacity, short-circuit withstand capability and follow current extinguishing capability, it is only possible to use type 1 SPDs as combined arresters in the main distribution board (MDB)/low voltage main distribution.

Here one simply distinguishes between SPDs with integrated fusing (**Figure 1**) and with external fusing (**Figure 2**).

In the case of external SPD fusing, the overcurrent protective device applied may not be tripped before reaching the maximum SPD I_{imp} (10/350 μ s) or I_n (8/20 μ s). The time-current characteristic of gG fuses is applied as a reference value for overcurrent protective devices. Should there be a circuit breaker upstream of the SPD, its characteristic must be compared with the characteristic of the maximum permissible gG fuse (**Table 1**).

As the actual protection level of the system is determined by the voltage drop over the connection wires and the external overcurrent protective device, SPDs with integrated fuses hold advantages because their protection level (U_p) already makes allowances for voltage drops via the fuse (**Figure 3**).

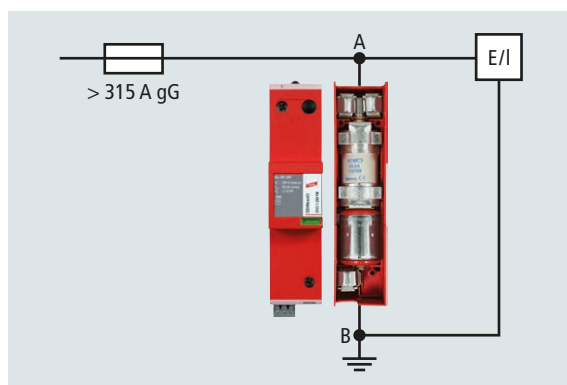

Figure 1 DEHNvenCI as a combined arrester SPD type 1 ($U_p \leq 1.5$ kV) with integrated SPD fuse protection

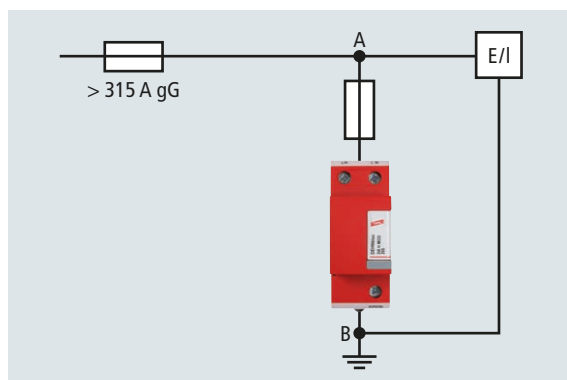

Figure 2 DEHNbloc modular as a coordinated arrester SPD type 1 ($U_p \leq 2.5$ kV) with external SPD fuse protection

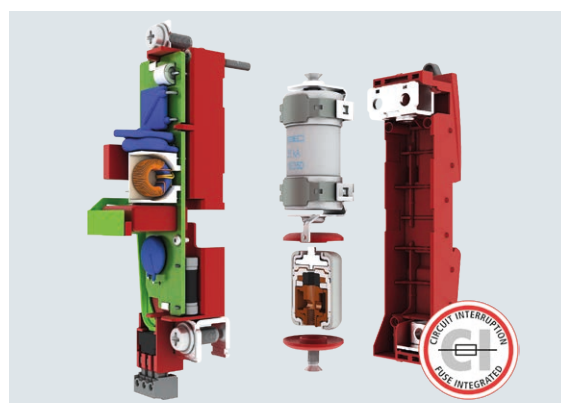

Figure 3 DEHNvenCI as a combined arrester SPD type 1 with integrated fuse protection

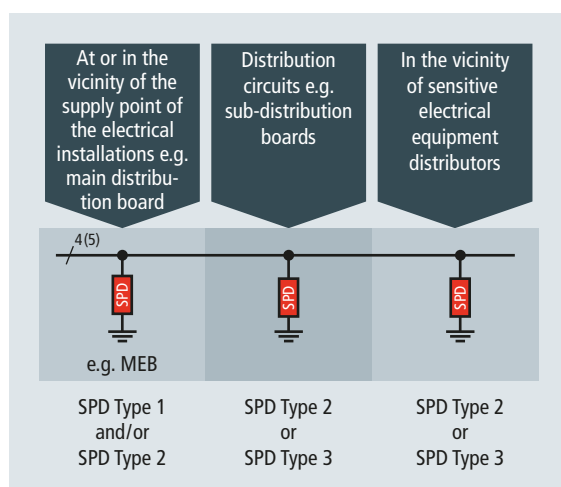

Figure 4 Energy-coordinated SPD downstream of the main distribution board

Surge protection in low-voltage switchgear assemblies

White Paper



	Surge arrester DEHNguard			Lightning current arrester DEHNventil		
	Nominal discharge current 20 kA (8/20 μ s) in TN-S system			Lightning current impulse 25 kA (10/350 μ s) in TN-S system		
Minimum cross section terminal	1.5 mm ²			10 mm ²		
Minimum cross section earthing conductor S3	6 mm ²			16 mm ²		
	Minimum cross section conductor S2 + S3 / impulse current carrying capability of fuse			Minimum cross section conductor S2 + S3 / impulse current carrying capability of fuse		
gG 63 A D02	10 mm ²	23.1 kA* 8/20 μ s				
gG 80 A D03	10 mm ²	23.2 kA* 8/20 μ s				
gG 100 A D03	16 mm ²	41.4 kA* 8/20 μ s				
gG 100 A NH	16 mm ²	n/a				
gG 125 A NH	16 mm ²	n/a	Max. overcurrent protective device	16 mm ²	11.3 kA* 10/350 μ s	
gG 160 A NH				25 mm ²	15.3 kA* 10/350 μ s	
gG 200 A NH				35 mm ²	19.7 kA* 10/350 μ s	
gG 250 A NH				35 mm ²	27.9 kA* 10/350 μ s	
gG 315 A NH				50 mm ²	34.2 kA* 10/350 μ s	Max. overcurrent protective device

* The kA values stated are calculated values according to IEC 61643-12
Lightning current in the TN-S system is distributed over 5 conductors.

Table 1 Cross-sectional area of PVC insulated copper conductors H-07VK depending on the nominal discharge current, lightning current and mains current related I²t value for max. 5 s

If the SPD in the main distribution board (MDB)/low voltage main distribution cannot guarantee the required rated impulse withstand voltage level, additional type 2 and type 3 SPDs are necessary in the system and/or further distribution boards. These SPDs must be energy-coordinated (Figure 4).

If the cable between the SPD and the electrical device (e.g. subsequent distribution board, terminal device) requiring protection is longer than 10 m, additional protection measures need to be taken.

The protection level U_p of the SPD should not exceed 80 % of the rated impulse withstand voltage level of the relevant

electrical equipment. The reason for this is the arising voltage drop ($U = L \cdot di/dt$) on the connection wire with a max. length of 0.5 m (active conductor to the SPD and from there to the PE/PEN conductor) (Figure 5). An exception to this is the equipotential bonding conductor from the SPD to the main/earthing busbar.

This need not be considered, if a connection version is selected which does not cause a voltage drop to the SPD, i.e. connection in series (Figure 6), or, as shown in Figure 3, when using an SPD set with integrated backup fuse.

Surge protection in low-voltage switchgear assemblies

White Paper

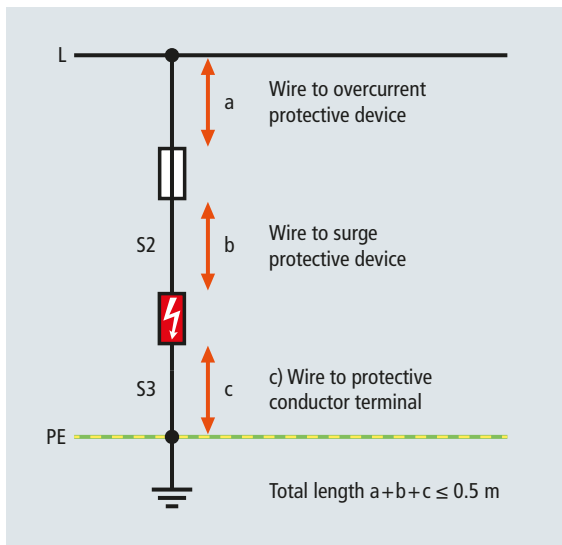

Figure 5 Maximum total length of wires of 0.5 m, which in connection with the 80% reduction still maintain the rated impulse withstand voltage

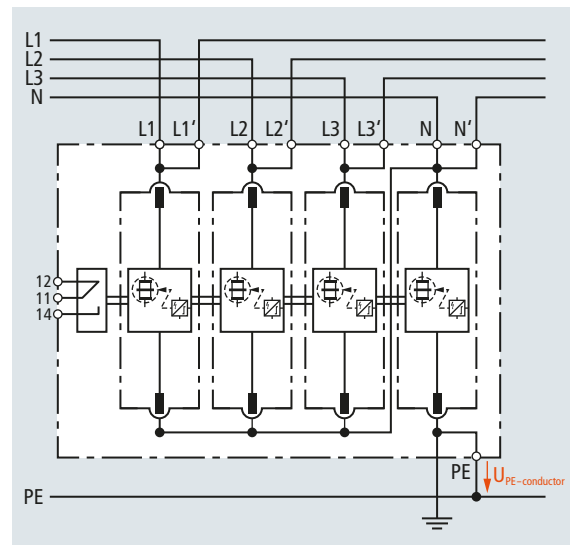

Figure 6 DEHNventil in series connection with low voltage drop $U_{PE-conductor}$ on the PE-conductor between the PE-terminal and double terminal for smaller main distribution boards up to max. 125 A load current

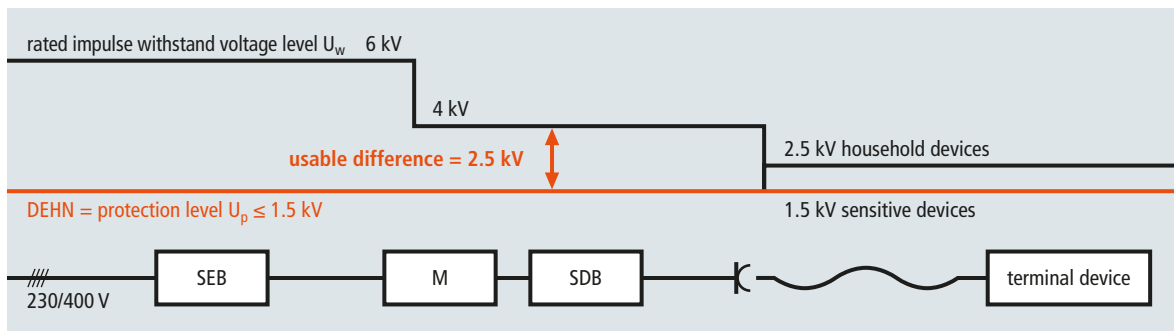

Figure 7 Usable voltage difference ($U_w - U_p$) through the use of a DEHNventil, to make it possible to use wires longer than 0.5 m

Voltage drop occurring			
Current impulse (8/20 μ s)	Voltage drop for cables laid straight [m]	0.5 m	2 m
5 kA	500 V	250 V	1000 V
10 kA	1000 V	500 V	2000 V
12,5 kA	1250 V	625 V	2500 V
20 kA	2000 V	1000 V	4000 V
25 kA	2500 V	1250 V	5000 V

Table 2 Voltage drop in connection cables with different impulse current loads

As the inductivity of a round conductor in the relevant cross-sectional area (16–50 mm²) is approx. 1 μ H/m, assuming an impulse current of 10kA 8/20 μ s, there is a drop in voltage of approx. 1 kV/m. This means that in a main distribution board with 4 kV rated impulse withstand voltage one could connect a DEHNventil ($U_p = 1.5$ kV) with an additional cable length of approx. 1 m (Figure 7). When calculating with higher or lower values than 25 kA 8/20 μ s, the cable lengths should be reduced or increased linearly (Table 2).

Here it is important to note that the original protection level of a DEHNventil ($U_p \leq 1.5$ kV) is now no longer available for electrical equipment with lower rated impulse withstand

Surge protection in low-voltage switchgear assemblies

White Paper

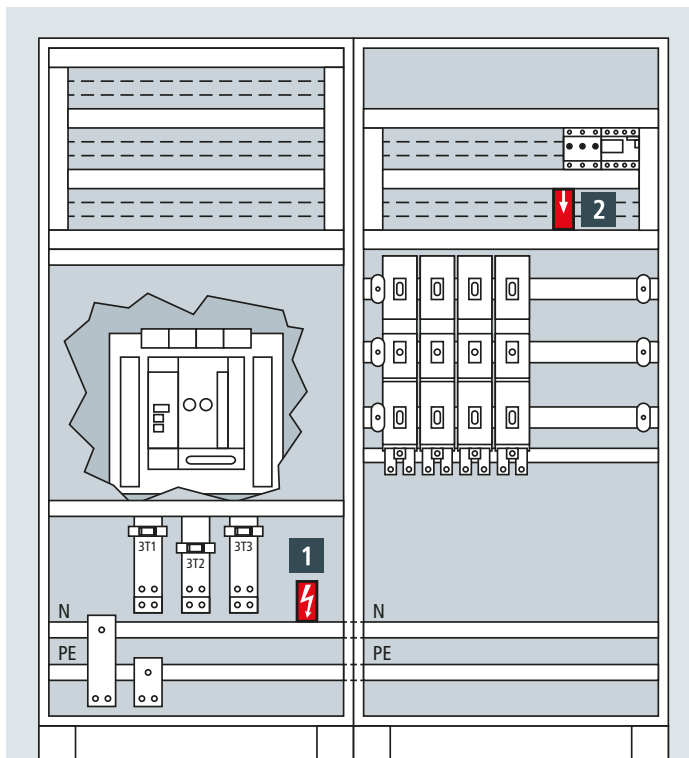

	Type	Info	Part. No.
1	DVCI 1 255 FM	4 pcs.	961 205
	DV M TNS 255 FM	1 pcs.	951 405
2	DG M TNS 275 FM	1 pcs.	952 405
	DG M TT 275 FM	1 pcs.	952 315

Figure 8 Main distribution board with longer connection wires than 0.5 m to type 1 or type 2 SPDs to comply with overvoltage category I (rated impulse withstand voltage ≤ 1.5 kV) in the outgoing panels

voltage and must therefore be ensured by SPDs with a lower protection level (Figure 8).

If local conditions do not permit the realisation of these requirements, the user has the following possibilities to solve this problem:

- ➔ Selection of an SPD with a lower protection level.
Table 2 offers help with regard to selection and arrangement. The values stated were interpolated with the formula $U = L \cdot di/dt$ in accordance with impulse current values at $8/20 \mu s$ to IEC 60364-5-53 (Table 2).
- ➔ Selection of an SPD with integrated backup fuse



Figure 9 Additional local equipotential bonding, e.g. via the metal enclosure/mounting plate of the switchgear installation

- ➔ Installation of a second, coordinated SPD at the equipment to be protected
- ➔ Connection in series
- ➔ Additional local equipotential bonding, e.g. via the metal enclosure of the switchgear installation (Figure 9).

If a TN-C system is fed into a main distribution board and the central earthing point is at the separation point of the PEN conductor to the PE and N conductor, another SPD in 3+0 configuration can be installed at a maximum distance of 0.5 m (Figure 10).

An important SPD parameter is the necessary short-circuit withstand capacity I_{SCCR} , which must be at least that of the short-circuit current occurring at the point of connection.

Protection of information technology cables

It should be noted, that although the IEC 60364-4-44 and IEC 60364-5-33 do not comprise the protection of data and telecommunications cables, they do clearly recommend that it is only possible to provide complete and effective surge protection if one includes these cables. When surge protection is required for the energy supply, it should also be considered for data cables.

Surge protection in low-voltage switchgear assemblies

White Paper

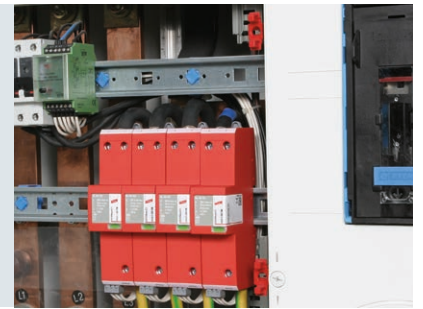

Nowadays, many functional modules in buildings have both a mains power supply and telecommunications connections. As a result, interference can be coupled through both channels. Typical information technology cables which should be connected are, e.g.

- ➔ Telephone and DSL connections
- ➔ Satellite and broadband cable systems

- ➔ Data lines (e.g. Ethernet)
- ➔ Building automation (e.g. KNX-Bus)
- ➔ Sensors (e.g. external sensors for heating).

DEHN offers a wide variety of solutions depending on the interface and the location. These include products which can simply be mounted on the wall, on a DIN rail or for KNX building automation (**Figure 11**).

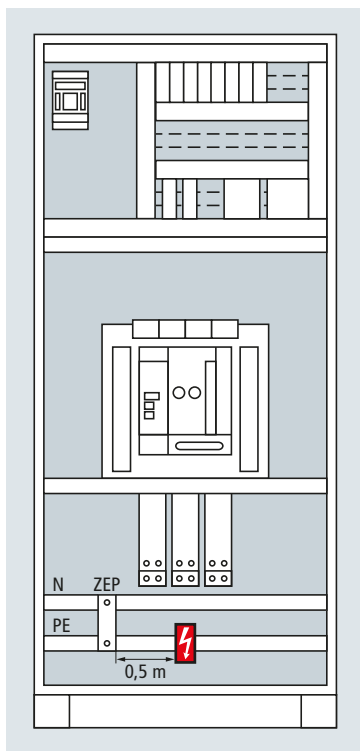

Figure 10 Possible application of 3 x DEHNvenCI in 3+0 configuration in the TN-S system under observation of the maximum distance of 0.5 m to the separation point PEN → PE + N



Figure 11 DEHNgate – coaxial arrester for satellite and broadband cable systems, BLITZDUCTOR for mounting on a DIN rail, DEHNpatch for the Ethernet port of a PC system, BUSStector for KNX building automation, DEHNpatch in 19" distributor, DEHNbox for simple and flexible wall-mounting

DEHNvenCI

DVCI 1 255 FM (961 205)

- Spark-gap-based combined lightning current and surge arrester with integrated lightning current carrying backup fuse
- Maximum system availability due to RADAX Flow follow current limitation
- Capable of protecting terminal equipment



Figure without obligation

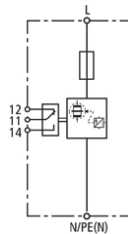

Basic circuit diagram DVCI 1 255 FM

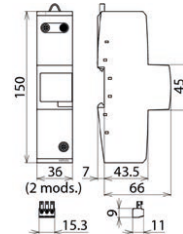

Dimension drawing DVCI 1 255 FM

Combined lightning current and surge arrester with integrated lightning current carrying backup fuse.

Type	DVCI 1 255 FM
Part No.	961 205
SPD according to EN 61643-11 / IEC 61643-11	type 1 + type 2 / class I + class II
Energy coordination with terminal equipment	type 1 + type 2
Energy coordination with terminal equipment (≤ 10 m)	type 1 + type 2 + type 3
Nominal voltage (a.c.) (U_N)	230 V (50 / 60 Hz)
Maximum continuous operating voltage (a.c.) (U_C)	255 V (50 / 60 Hz)
Lightning impulse current (10/350 μ s) (I_{imp})	25 kA
Specific energy (W/R)	156.25 kJ/ohms
Nominal discharge current (8/20 μ s) (I_n)	25 kA
Voltage protection level (U_P)	≤ 1.5 kV
Follow current extinguishing capability (a.c.) (I_f)	50 kA _{rms}
Follow current limitation / Selectivity	no tripping of a 20 A gG fuse up to 50 kA _{rms} (prosp.)
Response time (t_A)	≤ 100 ns
Max. mains-side overcurrent protection	not required
Rated breaking capacity of the internal backup protection	100 kA
Temporary overvoltage (TOV) (U_T) – Characteristic	440 V / 120 min. – withstand
Operating temperature range (T_U)	-40 °C ... +80 °C
Operating state / fault indication	green / red
Number of ports	1
Cross-sectional area (L, N/PE(N)) (min.)	10 mm ² solid / flexible
Cross-sectional area (L, N/PE(N)) (max.)	50 mm ² stranded / 35 mm ² flexible
For mounting on	35 mm DIN rails acc. to EN 60715
Enclosure material	thermoplastic, red, UL 94 V-0
Place of installation	indoor installation
Degree of protection	IP 20
Capacity	2 module(s), DIN 43880
Approvals	KEMA
Type of remote signalling contact	changeover contact
Switching capacity (a.c.)	250 V / 0.5 A
Switching capacity (d.c.)	250 V / 0.1 A; 125 V / 0.2 A; 75 V / 0.5 A
Cross-sectional area for remote signalling terminals	max. 1.5 mm ² solid / flexible
Extended technical data:	For use in switchgear installations with prospective short-circuit currents of more than 50 kA _{rms} (tested by the German VDE)
– Max. prospective short-circuit current	100 kA _{rms} (220 kA _{peak})
– Limitation / Extinction of mains follow currents	up to 100 kA _{rms} (220 kA _{peak})
Weight	435 g
Customs tariff number (Comb. Nomenclature EU)	85363090
GTIN	4013364145115
PU	1 pc(s)

DEHNventil

DV M TNS 255 FM (951 405)

- Prewired spark-gap-based type 1 and type 2 combined lightning current and surge arrester consisting of a base part and plug-in protection modules
- Maximum system availability due to RADAX Flow follow current limitation
- Capable of protecting terminal equipment



Figure without obligation

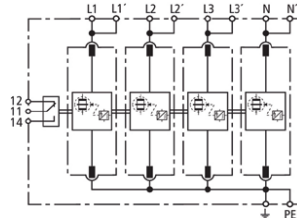

Basic circuit diagram DV M TNS 255 FM

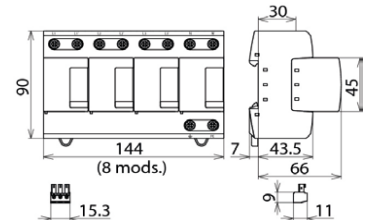

Dimension drawing DV M TNS 255 FM

Modular combined lightning current and surge arrester for TN-S systems.

Type	DV M TNS 255 FM
Part No.	951 405
SPD according to EN 61643-11 / IEC 61643-11	type 1 + type 2 / class I + class II
Energy coordination with terminal equipment (≤ 10 m)	type 1 + type 2 + type 3
Nominal voltage (a.c.) (U_N)	230 / 400 V (50 / 60 Hz)
Max. continuous operating voltage (a.c.) (U_C)	264 V (50 / 60 Hz)
Lightning impulse current (10/350 μ s) [L1+L2+L3+N-PE] (I_{total})	100 kA
Specific energy [L1+L2+L3+N-PE] (W/R)	2.50 MJ/ohms
Lightning impulse current (10/350 μ s) [L, N-PE] (I_{imp})	25 kA
Specific energy [L,N-PE] (W/R)	156.25 kJ/ohms
Nominal discharge current (8/20 μ s) [L/N-PE]/[L1+L2+L3+N-PE] (I_n)	25 / 100 kA
Voltage protection level [L-PE]/[N-PE] (U_p)	≤ 1.5 / ≤ 1.5 kV
Follow current extinguishing capability (a.c.) (I_f)	50 kA _{rms}
Follow current limitation / Selectivity	no tripping of a 20 A gG fuse up to 50 kA _{rms} (prosp.)
Response time (t_A)	≤ 100 ns
Max. backup fuse (L) up to $I_k = 50$ kA _{rms}	315 A gG
Max. backup fuse (L-L')	125 A gG
Temporary overvoltage (TOV) [L-N] (U_T) – Characteristic	440 V / 120 min. – withstand
Operating temperature range [parallel] / [series] (T_U)	-40 °C ... +80 °C / -40 °C ... +60 °C
Operating state / fault indication	green / red
Number of ports	1
Cross-sectional area (L1, L1', L2, L2', L3, L3', N, N', PE, \pm) (min.)	10 mm ² solid / flexible
Cross-sectional area (L1, L2, L3, N, PE) (max.)	50 mm ² stranded / 35 mm ² flexible
Cross-sectional area (L1', L2', L3', N', \pm) (max.)	35 mm ² stranded / 25 mm ² flexible
For mounting on	35 mm DIN rails acc. to EN 60715
Enclosure material	thermoplastic, red, UL 94 V-0
Place of installation	indoor installation
Degree of protection	IP 20
Capacity	8 module(s), DIN 43880
Approvals	KEMA, VDE, UL
Type of remote signalling contact	changeover contact
Switching capacity (a.c.)	250 V / 0.5 A
Switching capacity (d.c.)	250 V / 0.1 A; 125 V / 0.2 A; 75 V / 0.5 A
Cross-sectional area for remote signalling terminals	max. 1.5 mm ² solid / flexible
Extended technical data:	For use in switchgear installations with prospective short-circuit currents of more than 50 kA _{rms} (tested by the German VDE)
– Max. prospective short-circuit current	100 kA _{rms} (220 kA _{peak})
– Limitation / Extinction of mains follow currents	up to 100 kA _{rms} (220 kA _{peak})
– Max. backup fuse (L) up to $I_k = 100$ kA _{rms}	315 A gG
Weight	1,36 kg
Customs tariff number (Comb. Nomenclature EU)	85363090
GTIN	4013364108165
PU	1 pc(s)

DEHNguard

DG M TT 275 FM (952 315)

- Prewired complete unit consisting of a base part and plug-in protection modules
- High discharge capacity due to heavy-duty zinc oxide varistors / spark gaps
- High reliability due to "Thermo Dynamic Control" SPD monitoring device



Figure without obligation

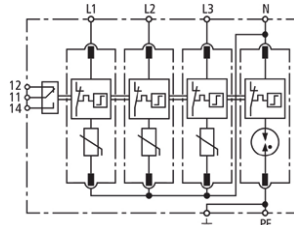

Basic circuit diagram DG M TT 275 FM

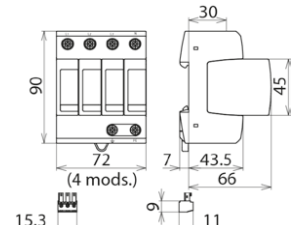

Dimension drawing DG M TT 275 FM

Modular surge arrester for use in TT and TN-S systems (3+1 configuration); with floating remote signalling contact.

Type	DG M TT 275 FM
Part No.	952 315
SPD according to EN 61643-11 / IEC 61643-11	type 2 / class II
Energy coordination with terminal equipment (≤ 10 m)	type 2 + type 3
Nominal voltage (a.c.) (U_N)	230 / 400 V (50 / 60 Hz)
Max. continuous operating voltage (a.c.) [L-N] (U_C)	275 V (50 / 60 Hz)
Max. continuous operating voltage (a.c.) [N-PE] (U_C)	255 V (50 / 60 Hz)
Nominal discharge current (8/20 μ s) (I_n)	20 kA
Max. discharge current (8/20 μ s) (I_{max})	40 kA
Lightning impulse current (10/350 μ s) [N-PE] (I_{imp})	12 kA
Voltage protection level [L-N]/[N-PE] (U_p)	≤ 1.5 / ≤ 1.5 kV
Voltage protection level [L-N] / [N-PE] at 5 kA (U_p)	≤ 1 / ≤ 1.5 kV
Follow current extinguishing capability [N-PE] (I_f)	100 A _{rms}
Response time [L-N] (t_A)	≤ 25 ns
Response time [N-PE] (t_A)	≤ 100 ns
Max. mains-side overcurrent protection	125 A gG
Short-circuit withstand capability for max. mains-side overcurrent protection (I_{SCCR})	50 kA _{rms}
Temporary overvoltage (TOV) [L-N] (U_T) – Characteristic	335 V / 5 sec. – withstand
Temporary overvoltage (TOV) [L-N] (U_T) – Characteristic	440 V / 120 min. – safe failure
Temporary overvoltage (TOV) [N-PE] (U_T) – Characteristic	1200 V / 200 ms – withstand
Operating temperature range (T_U)	-40 °C ... +80 °C
Operating state / fault indication	green / red
Number of ports	1
Cross-sectional area (min.)	1.5 mm ² solid / flexible
Cross-sectional area (max.)	35 mm ² stranded / 25 mm ² flexible
For mounting on	35 mm DIN rails acc. to EN 60715
Enclosure material	thermoplastic, red, UL 94 V-0
Place of installation	indoor installation
Degree of protection	IP 20
Capacity	4 module(s), DIN 43880
Approvals	KEMA, VDE, UL
Type of remote signalling contact	changeover contact
Switching capacity (a.c.)	250 V / 0.5 A
Switching capacity (d.c.)	250 V / 0.1 A; 125 V / 0.2 A; 75 V / 0.5 A
Cross-sectional area for remote signalling terminals	max. 1.5 mm ² solid / flexible
Extended technical data:	-----
Voltage protection level [L-PE] (U_p)	1.5 kV
Weight	415 g
Customs tariff number (Comb. Nomenclature EU)	85363030
GTIN	4013364108486
PU	1 pc(s)

DEHNguard

DG M TNS 275 FM (952 405)

- Prewired complete unit consisting of a base part and plug-in protection modules
- High discharge capacity due to heavy-duty zinc oxide varistors / spark gaps
- High reliability due to "Thermo Dynamic Control" SPD monitoring device



Figure without obligation

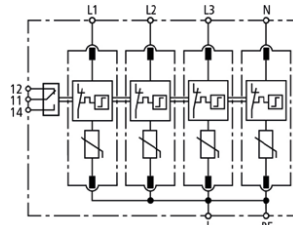

Basic circuit diagram DG M TNS 275 FM

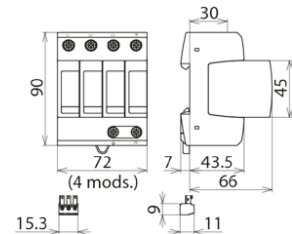

Dimension drawing DG M TNS 275 FM

Modular surge arrester for use in TN-S systems; with floating remote signalling contact.

Type	DG M TNS 275 FM
Part No.	952 405
SPD according to EN 61643-11 / IEC 61643-11	type 2 / class II
Energy coordination with terminal equipment (≤ 10 m)	type 2 + type 3
Nominal voltage (a.c.) (U_N)	230 / 400 V (50 / 60 Hz)
Max. continuous operating voltage (a.c.) (U_C)	275 V (50 / 60 Hz)
Nominal discharge current (8/20 μ s) (I_n)	20 kA
Max. discharge current (8/20 μ s) (I_{max})	40 kA
Voltage protection level [L-PE]/[N-PE] (U_P)	≤ 1.5 / ≤ 1.5 kV
Voltage protection level [L-PE] / [N-PE] at 5 kA (U_P)	≤ 1 / ≤ 1 kV
Response time (t_A)	≤ 25 ns
Max. mains-side overcurrent protection	125 A gG
Short-circuit withstand capability for max. mains-side overcurrent protection (I_{SCCR})	50 kA _{rms}
Temporary overvoltage (TOV) (U_T) – Characteristic	335 V / 5 sec. – withstand
Temporary overvoltage (TOV) (U_T) – Characteristic	440 V / 120 min. – safe failure
Operating temperature range (T_U)	-40 °C ... +80 °C
Operating state / fault indication	green / red
Number of ports	1
Cross-sectional area (min.)	1.5 mm ² solid / flexible
Cross-sectional area (max.)	35 mm ² stranded / 25 mm ² flexible
For mounting on	35 mm DIN rails acc. to EN 60715
Enclosure material	thermoplastic, red, UL 94 V-0
Place of installation	indoor installation
Degree of protection	IP 20
Capacity	4 module(s), DIN 43880
Approvals	KEMA, VDE, UL
Type of remote signalling contact	changeover contact
Switching capacity (a.c.)	250 V / 0.5 A
Switching capacity (d.c.)	250 V / 0.1 A; 125 V / 0.2 A; 75 V / 0.5 A
Cross-sectional area for remote signalling terminals	max. 1.5 mm ² solid / flexible
Weight	453 g
Customs tariff number (Comb. Nomenclature EU)	85363030
GTIN	4013364108462
PU	1 pc(s)

Surge Protection
Lightning Protection
Safety Equipment
DEHN protects.

DEHN SE
Hans-Dehn-Str. 1
Postfach 1640
92306 Neumarkt, Germany

Tel. +49 9181 906-0
Fax +49 9181 906-1100
info@dehn.de
www.dehn-international.com



www.dehn-international.com/partners

Type designations of products mentioned in this white paper which are at the same time registered trademarks are not especially marked. Hence the absence of TM or [®] markings does not indicate that the type designation is a free trade name. Nor can it be seen whether patents or utility models and other intellectual and industrial property rights exist. We reserve the right to introduce changes in performance, configuration and technology, dimensions, weights and materials in the course of technical progress. The figures are shown without obligation. Misprints, errors and modifications excepted. Reproduction in any form whatsoever is forbidden without our authorisation.