

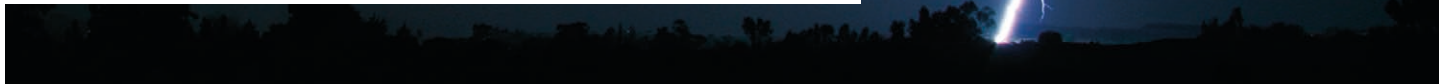

Lightning and surge protection for electromobility

White Paper



Contents

- Danger during thunderstorms
- Damage caused during charging
- What happens if lightning strikes when charging?
- What do the standards have to say?
- Causes of transient overvoltage
- Selection of surge protective devices
- Earthing and equipotential bonding



Lightning and surge protection for electromobility

White Paper



Danger during thunderstorms

Several billion flashes of lightning come down in the world every year. In Germany alone, an average of 1.5 million lightning events are counted each year and the tendency is rising. If lightning strikes nearby, buildings and the infrastructure often suffer damage: lightning strikes can cause fires and/or surge damage to electrical devices and systems. The latter may occur even if the actual strike was up to 2 km away. In addition, switching electrical power, e.g. on the charging post, and switching operations in transformer stations generate switching overvoltages which can also have negative effects. It frequently only takes a small amount of energy to cause significant damage.

Damage caused during charging

Constant availability of electrical power is a decisive factor for the charging process. The fact that charging stations are primarily erected outside means that they are especially susceptible to the effects of lightning discharge and the resulting surges which might exceed the dielectric strength of the electrical components within the charging post many times over. Furthermore, voltage peaks in the power grid from, e.g. switching operations or earth faults and short-circuits, should be regarded as a possible threat. The consequences are defective electronic components and a charging post which is out of order. Should the surge occur during the charging process

itself, it can even damage the actual vehicle (e.g. the charge controller or battery). It is therefore advisable to consider a reliable lightning and surge protection concept in order to avoid such financially damaging consequences and minimise repairs and maintenance.

What happens if lightning strikes when charging?

In case of a direct lightning strike, e.g. in a street lamp, a partial lightning current can flow to the charging post. This can be conducted directly into the vehicle via the attached charging cable where it may destroy the charging electronics or even the battery.

If a surge protective device has been installed, the lightning current and the overvoltage is discharged directly via the protective device and the charging equipment and vehicle remain intact (Figure 1).

What do the standards have to say?

Publication VdS 3471, issued by the VdS (German insurer for damage prevention), on 'Charging stations for electrical vehicles' states on the topic of surge protection that according to IEC 60364-4-44, clause 443 the evaluation of whether additional surge protective measures are necessary depends on the overvoltage category stated by the manufacturer.

Standards in the series IEC 60364 are installation standards and therefore apply to fixed installations. Charging posts

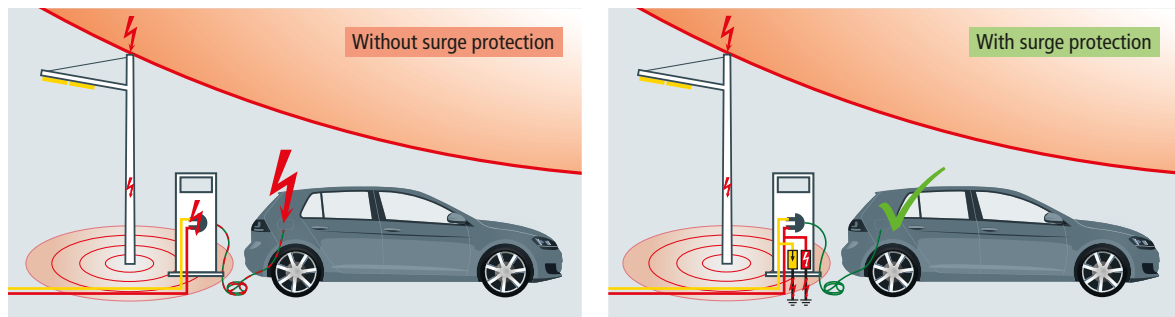

Figure 1 Lightning and surge coupling when charging

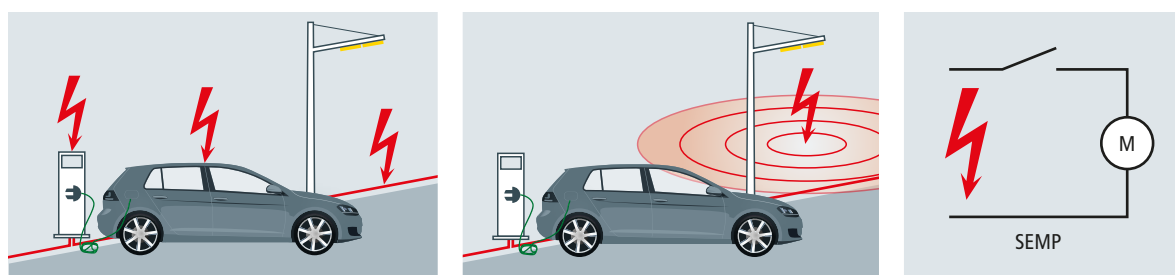

Figure 2 Causes of overvoltage

Lightning and surge protection for electromobility

White Paper

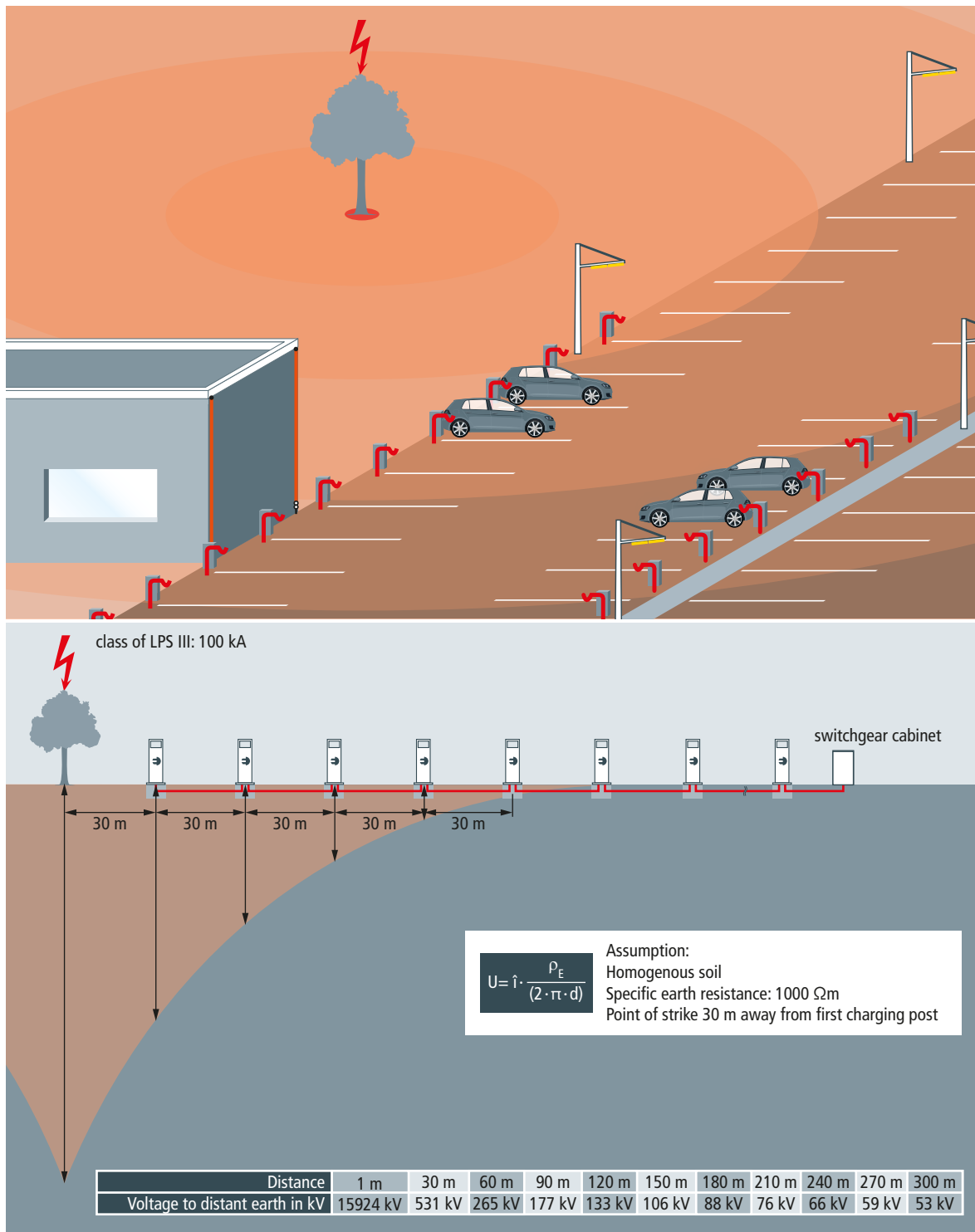

Figure 3 Potential gradient area for a lightning strike in the immediate vicinity of a charging station

Lightning and surge protection for electromobility

White Paper



which are not portable and are connected via fixed wiring fall under the scope of IEC 60364.

IEC 60364-4-44, clause 443 deals with the protection of electrical installations against transient overvoltages of atmospheric origin which are transmitted through the power grid, including direct lightning strikes in power lines and transient overvoltages due to switching operations. It explains whether surge protective measures are necessary, assesses the risk of the location, defines overvoltage categories and the correspondingly required rated impulse withstand voltage level for the equipment and defines whether additional surge protective devices are necessary. Furthermore, it expands on the required availability of the system. If the risk of direct lightning strikes needs to be considered, lightning protection standard IEC 62305 should also be applied.

Should lightning and surge protective measures be applied in compliance with IEC 60364-4-44, clause 443 and EN 62305, these should be installed according to IEC 60364-5-53, clause 534. Please note that a revised version of the standard IEC 60364-7-722 was published in June 2019. This stipulates the requirement for surge protection in publicly accessible charging facilities.

In Germany, VDE-AR-N-4100 must be additionally observed for charging posts which are directly connected to the low-voltage system.

VDE-AR-N-4100 describes, among other things, additional requirements on type 1 arresters used in the main power supply system, for example:

- ➔ Type 1 SPDs must comply with the IEC 61643-11 product standard

- ➔ Only voltage-switching type 1 SPDs (with spark gap) may be used. SPDs with one or more varistors or parallel connection of a spark gap and a varistor are prohibited.

- ➔ Type 1 SPDs must not cause operating current resulting from status displays, e.g. LEDs.

Causes of transient overvoltage

A direct strike to the charging post or the supply line produces lightning current which is simulated under test conditions with the impulse shape 10/350 μ s. Distant lightning strikes or so-called indirect lightning strikes lead to conducted partial lightning currents (impulse shape 10/350 μ s) in the supply lines or also to inductive/capacitive coupling (impulse shape 8/20 μ s) in the charging stations themselves. In addition, overvoltage can be caused by switching operations, earth faults and short circuits or when fuses trip (SEMP – switching electromagnetic pulse) (Figure 2 and 3).

Surge protection should be selected according to IEC 60364-5-53, clause 534 depending on the location of the charging post or wall box (Figure 4). If the charging post or its wiring are in zone 0_A, galvanic coupling of partial lightning currents as well as inductive and capacitive coupling must be expected in case of a nearby or distant lightning strike. Type 1 + 2 + 3 combined arresters, e.g. DEHNvap EMOB, should be installed in the charging posts to control these interference impulses. If the charging posts or wall boxes and their wiring are in zone 0_B, i.e. in an area protected against strikes, one only needs to reckon with inductive and capacitive coupling from lightning discharge. In this case, type 2 + 3 surge arresters like, for example, DEHNcord 3P should be installed:

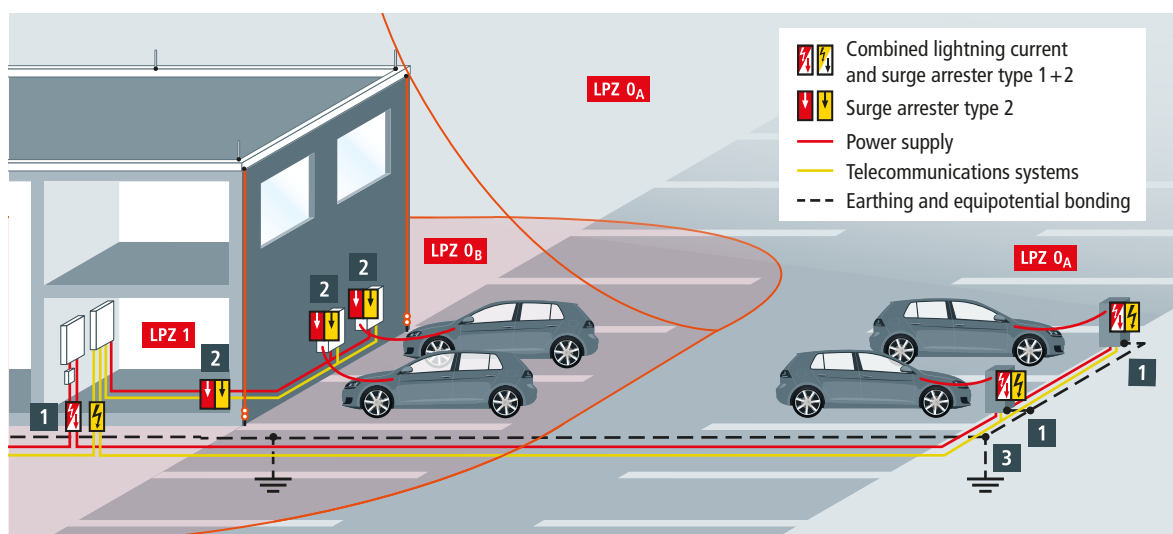

Figure 4 Application of lightning and surge protective devices depending on location

Lightning and surge protection for electromobility

White Paper



No.	Type	Part No.	Other
Protection against the direct and indirect effects of lightning			
1	Combined arrester type 1 + 2 + 3 230/400V (50/60 Hz)	DEHNvap EMOB DVA EMOB 3P 255 FM	900 385 TT and TN system, DIN rail mounting
	DC applications	DEHNguard ME DC DG ME DC Y 950 FM	972 146 max. continuous operating voltage DC 950 V
	Data and communication lines*	BLITZDUCTOR connect BCO ML2 BD 24	927 244 Modular combined lightning current and surge arrester with status indication
Protection against the indirect effects of lightning			
2	Combined arrester type 2 + 3	DEHNcord 3P DCOR 3P TT 275 FM	900 439 TT and TN system, DIN rail and wall mounting
	DC applications	DEHNguard SE DC DG SE DC 900 FM	972 145 e.g. highest continuous operating voltage DC 900 V
	Data and communication lines*	BLITZDUCTOR connect BCO ML2 BD 24	927 244 Modular combined lightning current and surge arrester with status indication
		DEHNpatch DPA CL8 EA 4PPOE	929 161 e.g. Power over Ethernet
Earthing and equipotential bonding			
3	Equipotential busbar	Cu/gal Sn PAS 11AK	563 200 Equipotential busbars for protective and functional equipotential bonding
	Round wire	StSt (V4A) RD 10 V4A R80M	860 010 10 mm round wire as a radial earth electrode
	Strip	StSt (V4A) BA 30X3.5 V4A R25M	860 325 Stainless steel strip for ring equi- potential bonding
	Earth rod	StSt (V4A) TE 20 1500 AZ V4A	620 902 Earth rod for implementing earth termination systems
	Connection clamp	StSt (V4A) AK 8.10 AQ4 50 TE20 25 V4A	540 121 Connection clamp for cross and parallel connection of round conduc- tors to earth rods
	Mesh mat	StSt (V4A) GMA 250 2000X1000X4 V4A	618 214 Mesh mat for potential grading
	Connection clamp	StSt (V4A) MMVK 3.5 8.10 SKM8X30 V4A	540 271 Connection clamp for connecting mesh mats to earth-termination systems
	Anti-corrosion tape	petrolatum KSB 50 L10M	556 125 Anti-corrosion tape for wrapping aboveground and underground con- nections

* Selection depending on the interface

Table 1 Selection aid for protecting electromobility – charging infrastructure (Figure 4)

- ➔ Due to its compact design in just 2 DIN modules, the DEHNcord 3P is even suitable for installation in wallboxes where space is very limited.
 - ➔ Due to its flexible installation possibilities, either on a DIN rail or using the screw lugs, the DEHNcord 3P is ideally suited for retrofitting.
 - ➔ Parallel or series connection is quick and easy thanks to double push-in technique.
- If it is not possible to reliably assess the potential threat, installing the compact and space-saving type 1 + 2 + 3 combined arrester DEHNvap EMOB is generally the best option. DEHNvap EMOB is based on RAC spark-gap technology and is spe-

Lightning and surge protection for electromobility

White Paper



cially designed for the requirements of power supply systems for the charging infrastructure. Its wave breaker function limits the residual energy to $< 0.5 \text{ J}$ so that even the most sensitive electronic components are protected. What is more, this KEMA certified arrester can be used without a backup fuse up to a nominal current of 250 A, and thus truly does offer universal protection.

If available, all copper data interfaces, such as Ethernet lines, must also be connected with suitable surge arresters such as DEHNpatch. This is the only way to ensure reliable protection and thus achieve the desired protection goal.

Selection of surge protective devices

When selecting suitable lightning and surge protective devices, it is not only important to know about the installation location, but also about the local system configuration, system voltage and nominal voltage of the charging facility. A possible selection is shown in **table 1**.

Earthing & equipotential bonding

If lightning current arresters type 1 or combined lightning current and surge arresters type 1 + 2 are installed in the charging posts, an additional separate local earthing must be provided

in accordance with IEC 60364-553, clause 534. In keeping with IEC 62305, this can be achieved, for example, by using earth rods with a minimum length of 2.5 m or alternatively with radial earth electrodes, e.g. round wire 10 mm with a minimum length of 5 m below the depth of frost. In this case, an earthing resistance of 10 Ohm is recommended.

If charging posts or wall boxes are connected directly to the low-voltage network, the requirements of VDE AR-N 4100 "Technical Rules for the Connection of Customer Systems to the Low-Voltage Network and their Operation" apply. This refers to DIN 18014 with regard to the purpose and installation of earthing systems. Based on this, a ring earth electrode must be provided. It should be made of permanently corrosion-resistant stainless steel V4A (or equivalent), 30 x 3.5 mm steel strip or 10 mm round wire. In the interest of complete lightning equipotential bonding, a meshed earthing system should always be used. It is therefore advisable to connect the respective charging points to each other in direct contact with the earth.

In addition, depending on the site conditions, an assessment must be made as to whether an area permanently occupied by people can pose a hazard with regard to step and contact voltage. If this is the case, additional potential control measures must be provided, e.g. lightning current-tested mesh mats.

DEHNvap EMOB

DVA EMOB 3P 255 FM (900 385)

- Universally applicable combined lightning current and surge arrester, particularly for use in power supply systems for the charging infrastructure
- Compact and space-saving installation thanks to spark gap technology with a width of only 1 module / pole
- Energy coordinated protective effect type 1 + type 2 + type 3 ensures protection of terminal equipment
- Residual energy in case of a S20K275 terminal device varistor < 0.5 J
- Maximum backup fuse up to 250 A gG
- Insulation measurement up to 500 V d.c. when connected



Figure without obligation

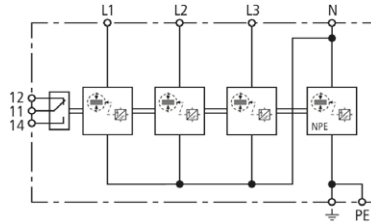

Basic circuit diagram DVA EMOB 3P 255 FM

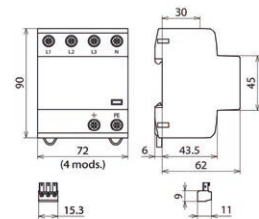

Dimension drawing DVA EMOB 3P 255 FM

Prewired combined lightning current and surge arrester for use in three-phase TT and TN-S systems (3+1 configuration) with remote signalling contact.

Type	DVA EMOB 3P 255 FM
Part No.	900 385
SPD according to EN 61643-11 / ... IEC 61643-11	type 1 + type 2 / class I + class II
Energy coordination with terminal equipment (≤ 10 m)	type 1 + type 2 + type 3
Nominal voltage (a.c.) (U_N)	230 / 400 V (50 / 60 Hz)
Max. continuous operating voltage (a.c.) [L-N]/[N-PE] (U_C)	255 V (50 / 60 Hz)
Lightning impulse current (10/350 μ s) [L-N]/[N-PE] (I_{imp})	12.5 / 50 kA
Specific energy [L-N]/[N-PE] (W/R)	39.06 kJ/ohms / 625.00 kJ/ohms
Nominal discharge current (8/20 μ s) (I_n)	25 / 100 kA
Voltage protection level [L-N]/[N-PE] (U_p)	≤ 1.5 kV / ≤ 1.5 kV
Follow current extinguishing capability [L-N]/[N-PE] (I_f)	25 kA _{rms} / 100 A _{rms}
Follow current limitation/Selectivity	no tripping of a 32 A gG fuse up to 25 kA _{rms} (prosp.)
Response time (t_A)	≤ 100 ns
Max. backup fuse (L) up to $I_k \leq 25$ kA _{rms}	250 A gG
Temporary overvoltage (TOV) [L-N] (U_T) – Characteristic	440 V / 120 min. – withstand
Temporary overvoltage (TOV) [N-PE] (U_T) – Characteristic	1200 V / 200 ms – withstand
Operating temperature range [parallel]/[series] (T_U)	-40°C...+80°C
Operating state/fault indication	green / red
Number of ports	1
Cross-sectional area (L1, L2, L3, N, PE, \varnothing) (min.)	1.5 mm ² solid / flexible
Cross-sectional area (L1, L2, L3, N, PE, \varnothing) (max.)	35 mm ² stranded / 25 mm ² flexible
For mounting on	35 mm DIN rails acc. to EN 60715
Enclosure material	thermoplastic, red, UL 94 V-0
Place of installation	indoor installation
Degree of protection	IP 20
Capacity	4 module(s), DIN 43880
Approvals	KEMA, UL
Type of remote signalling contact	changeover contact
Switching capacity (a.c.)	250 V / 0.5 A
Switching capacity (d.c.)	250 V / 0.1 A; 125 V / 0.2 A; 75 V / 0.5 A
Cross-sectional area for remote signalling terminals	max. 1.5 mm ² solid / flexible
Insulation measurement possible when connected	up to 500 V DC
Extended technical data:	-----
- Additional abnormal voltage test: 485 V AC / 50 Hz for 24 h	withstand
- Residual energy with a S20K275	< 0.5 J
- Characteristic at U = 320 V and I _{SCCR} = 13.5 kA in combination with a fuse 63 A gG	withstand
Weight	472 g
Customs tariff number (Comb. Nomenclature EU)	85363090
GTIN	4013364422186
PU	1 pc(s)

DEHNguard ME

DG ME DC Y 950 FM (972 146)

- Powerful d.c. switching device DCD



Figure without obligation

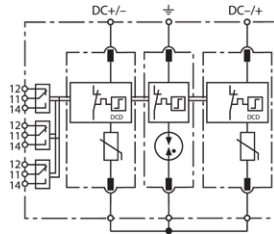

Basic circuit diagram DG ME DC Y 950 FM

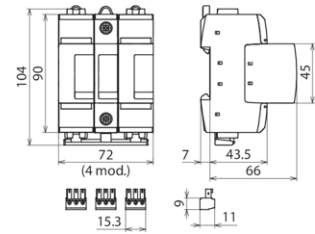

Dimension drawing DG ME DC Y 950 FM

Modular combined lightning current and surge arrester for d.c. applications; with floating remote signalling contact.

Type Part No.	DG ME DC Y 950 FM 972 146
SPD analogous to EN 61643-11 / IEC 61643-11	type 1 + type 2 / class I + class II
Nominal voltage (d.c.) (U_N)	860 V
Max. continuous operating voltage (d.c.) (U_C)	950 V
Lightning impulse current (10/350 μ s) (I_{imp})	5 kA
Nominal discharge current (8/20 μ s) (I_n)	12.5 kA
Voltage protection level [DC+ -> DC-] (U_P)	≤ 4 kV
Voltage protection level [(DC+/DC-) --> PE] (U_P)	≤ 3.2 kV
Max. short circuit withstand capability (I_{SCCR})	500 A / 170 ms
Temporary overvoltage (TOV) [DC+ -> DC-] (U_T) – Characteristic	950 V ($U_{TOV} = U_C$)
Temporary overvoltage (TOV) [DC+/- -> PE] (U_T) – Characteristic	950 V / 10 sec. – withstand
Operating temperature range (T_U)	-40 °C ... +80 °C
Operating state / fault indication	green / red
Number of ports	1
Cross-sectional area (min.)	1.5 mm ² solid / flexible
Cross-sectional area (max.)	35 mm ² stranded / 25 mm ² flexible
For mounting on	35 mm DIN rails acc. to EN 60715
Enclosure material	thermoplastic, red, UL 94 V-0
Place of installation	indoor installation
Degree of protection	IP20
Capacity	4 module(s), DIN 43880
Approvals	UL
Type of remote signalling contact	changeover contact
Switching capacity (a.c.)	250 V / 0.5 A
Switching capacity (d.c.)	250 V / 0.1 A; 125 V / 0.2 A; 75 V / 0.5 A
Cross-sectional area for remote signalling terminals	max. 1.5 mm ² solid / flexible
Extended technical data:	-----
– Residual voltage (U_{res}) @ 1.2 kA	2,5 kV
– Use in DC battery storage systems up to I_{SCCR}	≤ 50 kA ($t \leq 4$ ms)
– Backup fuse for DC battery storage systems up to I_{SCCR}	Bussman HLS 2000Vdc / 200 A 2+/A173 DST aR, manufacturer's Part No.: 170M2040
Weight	497 g
Customs tariff number (Comb. Nomenclature EU)	85363030
GTIN	4013364347960
PU	1 pc(s)

DEHNguard SE

DG SE DC 900 FM (972 145)

- Universal single-pole surge arrester consisting of a base part and a plug-in protection module
- Powerful d.c. switching device DCD
- Can be used without additional backup fuse



Figure without obligation

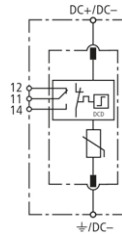

Basic circuit diagram DG SE DC 900 FM

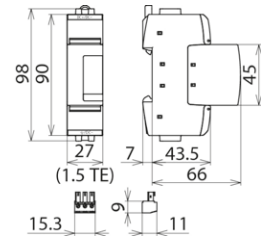

Dimension drawing DG SE DC 900 FM

Modular single-pole surge arrester for d.c. applications; with floating remote signalling contact.

Type	DG SE DC 900 FM
Part No.	972 145
SPD according to EN 61643-11 / IEC 61643-11	type 2 / class II
Energy coordination with terminal equipment (≤ 10 m)	type 2 + type 3
Nominal voltage (d.c.) (U_N)	750 V
Max. continuous operating voltage (d.c.) (U_C)	900 V
Nominal discharge current (8/20 μ s) (I_n)	12.5 kA
Voltage protection level (U_P)	≤ 3.0 kV
Response time (t_A)	≤ 25 ns
Short-circuit withstand capability without backup fuse (d.c.) (I_{SCCR})	100 A
Short-circuit withstand capability for max. mains-side overcurrent protection (d.c.) (I_{SCCR})	25 kA
Max. mains-side overcurrent protection	80 A gPV
Temporary overvoltage (TOV) d.c. (U_T) - Characteristic	1089 V / 5 sec. – withstand
Temporary overvoltage (TOV) d.c., $2 \times U_C$ (U_T) - Characteristic	1800 V / 120 min. – safe failure
Operating temperature range (T_U)	-40 °C ... +80 °C
Operating state / fault indication	green / red
Number of ports	1
Cross-sectional area (min.)	1.5 mm ² solid / flexible
Cross-sectional area (max.)	35 mm ² stranded / 25 mm ² flexible
For mounting on	35 mm DIN rails acc. to EN 60715
Enclosure material	thermoplastic, red, UL 94 V-0
Place of installation	indoor installation
Degree of protection	IP20
Capacity	1.5 module(s), DIN 43880
Type of remote signalling contact	changeover contact
Switching capacity (a.c.)	250 V / 0.5 A
Switching capacity (d.c.)	250 V / 0.1 A; 125 V / 0.2 A; 75 V / 0.5 A
Cross-sectional area for remote signalling terminals	max. 1.5 mm ² solid / flexible
Extended technical data:	use for safety lighting systems
– d.c. and a.c. operation	no
Weight	172 g
Customs tariff number (Comb. Nomenclature EU)	85363030
GTIN	4013364158658
PU	1 pc(s)

DEHNcord

DCOR 3P TT 275 FM (900 439)

- Extremely compact design
- Visual fault indication, with remote signalling contact
- Optionally mounted on DIN rails or using special screw lugs
- Double push-in technology – For series or parallel connection



Figure without obligation

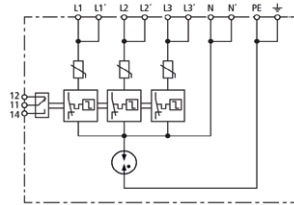

Basic circuit diagram DCOR 3P TT 275 FM

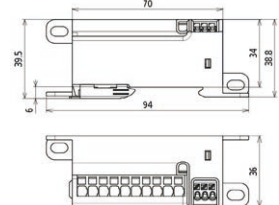

Dimension drawing DCOR 3P TT 275 FM

Compact three-phase arrester for for TT and TN-S systems.

Technical data

Type	DCOR 3P TT 275 FM
Part No.	900 439
SPD according to EN 61643-11 / IEC 61643-11	type 2 + type 3 / class II + class III
Nominal voltage (a.c.) (U_N)	230 V (50 / 60 Hz)
Max. continuous operating voltage (a.c.) [L-N] (U_C)	275 V (50 / 60 Hz)
Max. continuous operating voltage (a.c.) [N-PE] (U_C)	255 V (50 / 60 Hz)
Max. continuous operating voltage (d.c.) (U_C)	350 V
Nominal load current (a.c.) / (d.c.) (I_L)	25 A
Nominal discharge current (8/20 μ s) [L-N] (I_n)	10 kA
Max. discharge current (8/20 μ s) [L-N] (I_{max})	20 kA
Nominal discharge current (8/20 μ s) [N-PE] (I_n)	10 kA
Max. discharge current (8/20 μ s) [N-PE] (I_{max})	40 kA
Total discharge current (8/20 μ s) [L+N-PE] (I_{total})	40 kA
Combination wave [L-N]/[N-PE] (U_{OC})	20 kV
Voltage protection level [L-N] (U_p)	≤ 1.5 kV
Voltage protection level [N-PE] (U_p)	≤ 1.5 kV
Follow current extinguishing capability [N-PE] (I_n)	100 A _{rms}
Response time [L-N] (t_A)	25 ns
Response time [L/N-PE] (t_A)	100 ns
Max. mains-side overcurrent protection (series connection)	25 A gG
Max. mains-side overcurrent protection (parallel connection)	40 A gG
Short-circuit withstand capability for mains-side overcurrent protection (I_{SCCR})	6 kA _{rms}
Temporary overvoltage (TOV) [L-N] (U_T) – Characteristic	335 V / 5 sec. – withstand
Temporary overvoltage (TOV) [L-N] (U_T) – Characteristic	440 V / 120 min. – safe failure
Temporary overvoltage (TOV) [N-PE] (U_T) – Characteristic	1200 V / 200 ms. – withstand
Insulation measurement	up to 500 V DC when connected
Operating state / fault indication	green / red
Cross-sectional area for push-in terminals	0.2 ... 6 mm ² solid / flexible
Number of ports	1
Operating temperature range (T_U)	-40 °C ... +80 °C
Enclosure material	thermoplastic, red, UL 94 V-2
Place of installation	indoor installation
Degree of protection of installed device	IP 20
Dimensions	2 modules, DIN 43880
Approvals	KEMA
Type of remote signalling contact	changeover contact
Switching capacity (a.c.)	250 V / 0.5 A
Switching capacity (d.c.)	250 V / 0.1 A; 125 V / 0.2 A; 75 V / 0.5 A
Cross-sectional area for remote signalling terminals	max. 1.5 mm ² solid / flexible
Weight	105 g
Customs tariff number (Comb. Nomenclature EU)	85363030
GTIN	4013364436053
PU	1 pc(s)

BLITZDUCTORconnect

BCO ML2 BD 24 (927 244)

- LifeCheck arrester monitoring and integrated status indication
- Modular two-pole arrester for optimal protection of one pair
- For installation in conformity with the lightning protection zone concept at the boundaries from $0_A - 2$ and higher



Figure without obligation

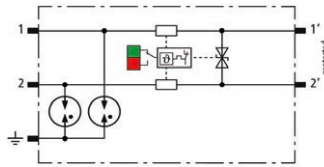

Basic circuit diagram BCO ML2 BD 24

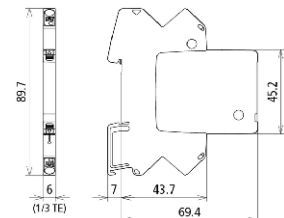

Dimension drawing BCO ML2 BD 24

Space-saving, modular combined arrester with a width of 6 mm and push-in connection technology with status indication for protecting one pair of unearthed balanced interfaces. With signal disconnection for maintenance purposes.

Type Part No.	BCO ML2 BD 24 927 244
SPD class	TYPE 1P2
Impulse category	D1, C1, C2, C3, B2
Nominal voltage (U_N)	24 V
Max. continuous operating voltage (d.c.) (U_C)	36 V
Max. continuous operating voltage (a.c.) (U_C)	25.4 V
Nominal current at 70 °C (I_L)	0.75 A
D1 Total lightning impulse current (10/350 μ s) (I_{imp})	3 kA
D1 Lightning impulse current (10/350 μ s) per line (I_{imp})	1.5 kA
C2 Total nominal discharge current (8/20 μ s) (I_n)	10 kA
C2 Nominal discharge current (8/20 μ s) per line (I_n)	5 kA
Voltage protection level line-line for I_n C2 (U_p)	≤ 57 V
Voltage protection level line-PG for I_n C2 (U_p)	≤ 600 V
Voltage protection level line-line for I_n C1 (U_p)	≤ 57 V
Voltage protection level line-PG for I_n C1 (U_p)	≤ 600 V
Voltage protection level line-line at 1 kV/ μ s C3 (U_p)	≤ 46 V
Voltage protection level line-PG at 1 kV/ μ s C3 (U_p)	≤ 600 V
Series resistance per line	1 ohm(s)
Cut-off frequency line-line (f_c)	5.8 MHz
Operating temperature range (T_U)	-40 °C ... +80 °C
Operating state / fault indication	green / red
Degree of protection	IP 20
Connection (input / output)	push-in / push-in
Cross-sectional area (solid)	0.2-2.5 mm ²
Cross-sectional area (flexible)	0.2-2.5 mm ²
Earthing via	35 mm DIN rails acc. to EN 60715
Enclosure material	polyamide PA 6.6
Colour	yellow
Test standards	IEC 61643-21 / EN 61643-21
Approvals	UL, CSA, EAC, ATEX, IECEx, CCC, SIL
ATEX approvals	TÜV 20 ATEX 8527 X: II 3G Ex ec IIC T4 Gc
IECEx approvals	IECEx TUR 20.0063X: Ex ec IIC T4 Gc
China Compulsory Certification	CCC no. 2021312304001192
Extended technical data:	-----
- Max. discharge current (8/20 μ s) [1/2 - PG], [1+2 - PG] (I_{max})	20 kA
- Discharge current (8/20 μ s) [1/2 - PG], [1+2 - PG]	10 kA (10x)
- Voltage protection level line-PG at 1 kV/ μ s C3 after being subjected to I_{max} (U_p)	≤ 600 V
Weight	34 g
Customs tariff number (Comb. Nomenclature EU)	85363010
GTIN	4013364405639
PU	1 pc(s)

Equipotential busbar



 **PAS 11AK (563 200)**

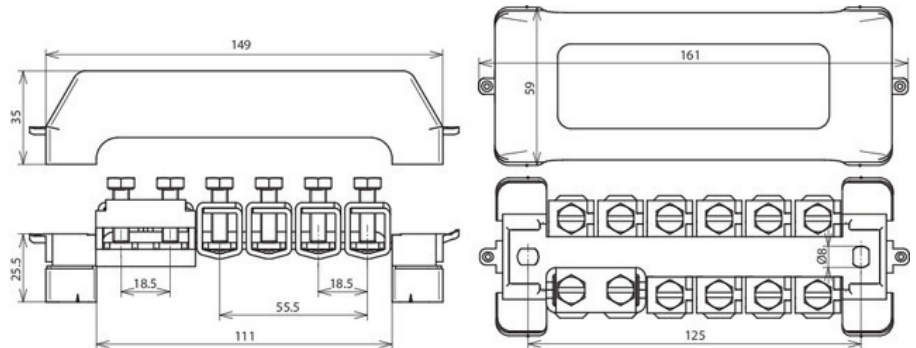

Figure without obligation



Arrangement: 

Type Part No.	PAS 11AK 563 200
Connection (solid / stranded)	10 x 2.5-95 mm ²
Connection Rd	or 10 x -10 mm
Connection FI	1 x -30 x 4 mm
Material of cage clamp	St/tZn
Material of contact rail	Cu/gal Sn
Cross section	30 mm ²
Fixing	[2x] 6 x 8 mm
Fixing frames	P (grey)
Cover	P (grey/sealable)
Lightning current carrying capability (10/350 µs)	 100 kA /  50 kA ^{*)}
Standard	EN 62561-1
Type	halogen-free
Weight	410 g
Customs tariff number (Comb. Nomenclature EU)	85389099
GTIN	4013364056558
PU	1 pc(s)

Connection clamp

MMVK 3.5 8.10 SKM8X30 V4A (540 271)



Figure without obligation

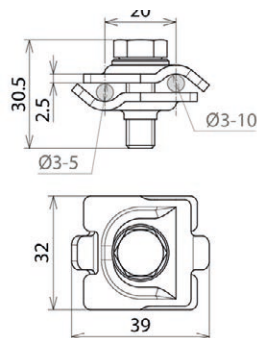

Arrangement:

Type	MMVK 3.5 8.10 SKM8X30 V4A
Part No.	540 271
Material of clamp	StSt (V4A)
Material No.	1.4571 / 1.4404 / 1.4401
ASTM / AISI:	316Ti / 316L / 316
Clamping range Rd / Rd	8-10 / 3-5 mm
Clamping range Rd / Rd	3-5 / 3-5 mm
Screw	● M8 x 30 mm
Material of screw / nut	StSt (V4A)
Lightning current carrying capability (10/350 µs)	25 kA ^{*)}
Standard	based on EN 62561-1
Weight	50 g
Customs tariff number (Comb. Nomenclature EU)	85389099
GTIN	4013364385306
PU	50 pc(s)

^{*)} For exact assignment see test certificate.

Anti-corrosion tape

KSB 50 L10M (556 125)



Figure without obligation

Anti-corrosion tape for wrapping aboveground and underground connections for use in the soil according to DIN 30672. In reels, length 10 m, UV stabilised.

Type	KSB 50 L10M
Part No.	556 125
Material	petrolatum
Length	10 m
Width	50 mm
Strenght	approx. 1 mm
Standard	DIN 30672
Type	UV-stabilised
Weight	560 g
Customs tariff number (Comb. Nomenclature EU)	68071000
GTIN	4013364028517
PU	24 pc(s)

Connection clamp

 **AK 8.10 AQ4 50 TE20 25 V4A (540 121)**



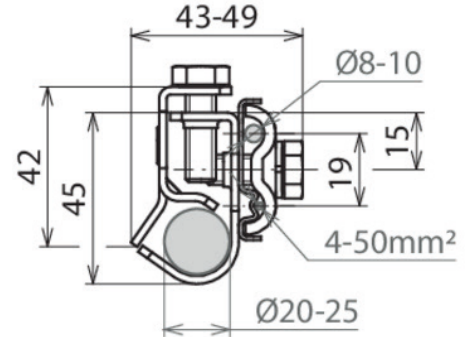
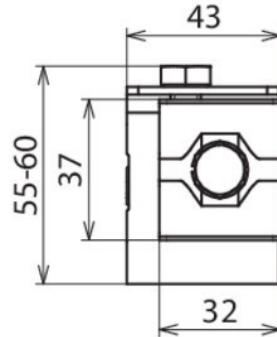

Figure without obligation



Connection clamp for lightning equipotential bonding connection of pipes (e.g. antenna poles) to the earth rod via a solid /stranded conductor.



Type	AK 8.10 AQ4 50 TE20 25 V4A
Part No.	540 121 ✓
Material	StSt (V4A)
Material No.	1.4571 / 1.4404 / 1.4401
ASTM / AISI:	316Ti / 316L / 316
For earth rods Ø	20-25 mm
Clamping range Rd	8-10 mm
Connection (solid / stranded)	4-50 mm ²
Screw	 M8 x 20 / 25 mm
Lightning current carrying capability (10/350 µs)	 100 kA ^{*)}
Standard	EN 62561-1
Weight	144 g
Customs tariff number (Comb. Nomenclature EU)	85389099
GTIN	4013364380660
PU	25 pc(s)

*)For exact classification, see test certificate.

Earth rod

TE 20 1500 AZ V4A (620 902)



Figure without obligation

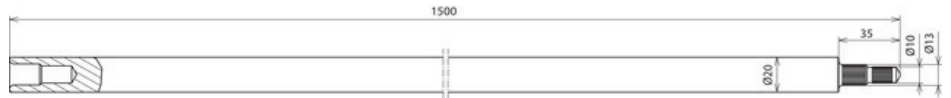

Type	TE 20 1500 AZ V4A
Part No.	620 902
Component protection	German Patent No. P 32 22 201.7
Material	StSt (V4A)
Material No.	1.4571 / 1.4404 / 1.4401
ASTM / AISI:	316Ti / 316L / 316
Rod length (l1)	1500 mm
Diameter Ø (d1)	20 mm
Pin diameter	10 / 13 mm
Tensile strength	500-730 N/mm ²
Specific conductivity	≥ 1.25 m/Ohm mm ²
Specific resistance	≤ 0.8 Ohm mm ² / m
Short-circuit current (a.c. 50 Hz / d.c.) (1 s; ≤ 300 °C)	4.2 kA
Standard	EN 62561-2
Weight	3,67 kg
Customs tariff number (Comb. Nomenclature EU)	85389099
GTIN	4013364021914
PU	6 pc(s)

Mesh mat

GMA 250 2000X1000X4 V4A (618 214)

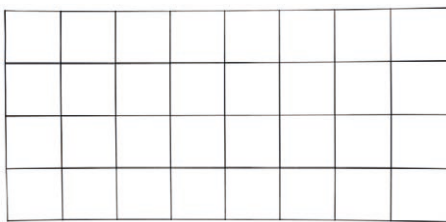
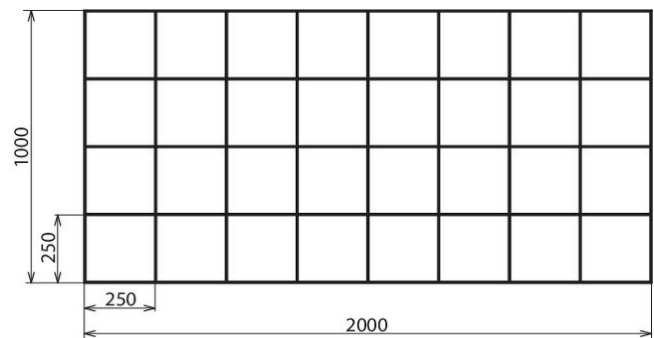

Figure without obligation



According to VDE/ABB Merkblatt "Blitzschutz von Schutzhütten" (VDE/ABB leaflet "Lightning protection of shelters")

Type	GMA 250 2000X1000X4 V4A
Part No.	618 214
Material	StSt (V4A)
Surface treatment	pickled and passivated
Material No.	1.4571 / 1.4404 / 1.4401
ASTM / AISI:	316Ti / 316L / 316
Dimensions (l x w x d)	2000 x 1000 x 4 mm
Mesh size	250 mm
Weight	2 kg
Customs tariff number (Comb. Nomenclature EU)	85389099
GTIN	4013364322950
PU	1 pc(s)

Round wire

RD 10 V4A R80M (860 010)



Figure without obligation

Stainless steel wire according to EN 62561-2, for lightning protection and earth-termination systems or equipotential bonding.

Stainless steel wires for use in soil have to be made of StSt (V4A) with a molybdenum content > 2 % e.g. 1.4571, 1.4404, in accordance with EN 62561-2 and IEC/EN 62305-3.

Type Part No.	RD 10 V4A R80M 860 010
Diameter Ø conductor	10 mm
Cross-section	78 mm ²
Material	StSt (V4A)
Material No.	1.4571 / 1.4404
ASTM / AISI:	316Ti / 316L
Standard	based on EN 62561-2
Conductivity	≥ 1.25 m / Ohm mm ²
Resistivity	≤ 0.8 Ohm mm ² / m
Short-circuit current (a.c. 50 Hz / d.c.) (1 s; ≤ 300 °C)	2.9 kA
Weight	617 g/m
Customs tariff number (Comb. Nomenclature EU)	72210010
GTIN	4013364019997
PU	80 m

Strip

BA 30X3.5 V4A R25M (860 325)



Figure without obligation

Stainless steel strip according to EN 62561-2, for lightning protection systems and ring equipotential bonding.

Stainless steel strip for use in soil have to be made of StSt (V4A) with a molybdenum content > 2 % e.g. 1.4571, 1.4404 in accordance with EN 62561-2, IEC/EN 62305-3 and DIN VDE 0151.

Type Part No.	BA 30X3.5 V4A R25M 860 325
Width	30 mm
Thickness	3.5 mm
Cross-section	105 mm ²
Material	StSt (V4A)
Material No.	1.4571 / 1.4404
ASTM / AISI:	316Ti / 316L
Standard	EN 62561-2
Conductivity	≥ 1.25 m / Ohm mm ²
Resistivity	≤ 0.8 Ohm mm ² / m
Short-circuit current (a.c. 50 Hz / d.c.) (1 s; ≤ 300 °C)	3.9 kA
Weight	825 g/m
Customs tariff number (Comb. Nomenclature EU)	72202021
GTIN	4013364093157
PU	25 m

Surge Protection
Lightning Protection
Safety Equipment
DEHN protects.

DEHN SE
Hans-Dehn-Str. 1
Postfach 1640
92306 Neumarkt, Germany

Tel. +49 9181 906-0
Fax +49 9181 906-1100
info@dehn.de
www.dehn-international.com



www.dehn-international.com/partners

Type designations of products mentioned in this white paper which are at the same time registered trademarks are not especially marked. Hence the absence of TM or [®] markings does not indicate that the type designation is a free trade name. Nor can it be seen whether patents or utility models and other intellectual and industrial property rights exist. We reserve the right to introduce changes in performance, configuration and technology, dimensions, weights and materials in the course of technical progress. The figures are shown without obligation. Misprints, errors and modifications excepted. Reproduction in any form whatsoever is forbidden without our authorisation.