



Lightning and surge protection for wind turbines

White Paper



Contents

- Lightning protection zone concept
- Shielding measures
- External and internal lightning protection measures
- Earth-termination system
- Selection of SPDs based on the voltage protection level (U_p) and the immunity of the equipment
- Protection of power supply and information technology systems
- Protection of the generator lines and the pitch system
- Condition monitoring
- Laboratory tests

Lightning and surge protection for wind turbines

White Paper



Due to their exposed location and height, wind turbines are vulnerable to the effects of direct lightning strikes. Several studies have shown that one must reckon with at least 10 direct lightning strikes to wind turbines in the multimegawatt range every year. The feed-in compensation must amortise the high investment costs within a few years, meaning that downtime caused by lightning and surge damage and the resulting repair costs must be avoided. For this reason, comprehensive lightning and surge protection measures are required.

When planning lightning protection measures, not only cloud-to-earth flashes, but also earth-to-cloud flashes, so-called upward leaders, must be considered for objects in exposed locations with a height of more than 60 m. These occur primarily in the winter months with charges higher than $Q = 300 \text{ C}$. It therefore makes sense to set higher requirements for conductor systems because it is the Q charges which are responsible for melting system parts and thus have a decisive influence on the maintenance of conductor systems, spark-gaps, etc. To give an example, the charge resulting from upward flashes during winter storms in Japan reached values of $Q = 600 \text{ C}$.

Standardisation

The IEC 61400-24 (EN 61400-24) standard, the IEC 62305 (EN 62305) standard series and the guidelines by Germanischer Lloyd (e.g. GL 2010 IV – Part 1: Guideline for the certification of wind turbines) form the basis for the protection concept.

Protection measures

The IEC 61400-24 (EN 61400-24) standard and GL 2010 guideline recommend protecting all sub-components of the lightning protection system of a wind turbine according to lightning protection level (LPL) I unless a risk analysis demonstrates that a lower LPL is sufficient. A risk analysis may also reveal that different sub-components have different LPLs. The IEC 61400-24 (EN 61400-24) standard recommends a comprehensive lightning protection concept.

Lightning protection (LP) for a wind turbine consists of an external lightning protection system (LPS) and surge protection measures (SPMs) for protecting electrical and electronic equipment.

In order to plan protection measures, it is advisable to subdivide the wind turbine into lightning protection zones (LPZs). The lightning protection system of a wind turbine protects two sub-systems which can only be found in wind turbines, namely the rotor blades and the mechanical drive train. The IEC 61400-24 (EN 61400-24) standard describes in detail how to protect these special parts of a wind turbine and how to prove the effectiveness of the lightning protection measures.

The standard recommends verifying the lightning current withstand capability of these systems in high-current tests with the first stroke and the long stroke, if possible, in a common discharge.

The following describes how to implement lightning and surge protection measures for the electrical and electronic devices/systems of a wind turbine. The complex problems concerning the protection of the rotor blades and rotatable mounted parts/bearings must be examined in detail and depend on the manufacturer and type. The IEC 61400-24 (EN 61400-24) standard provides important information in this respect.

Lightning protection zone concept

The lightning protection zone concept is a structuring measure to create a defined EMC environment in an object. This defined EMC environment depends on the immunity of the electrical equipment used. The lightning protection zone concept therefore, includes reducing conducted and field-bound interference at the boundaries to defined values as a protective measure. For this reason, the object to be protected is subdivided into protection zones.

The rolling sphere method is used to determine LPZ 0_A , namely the parts of a wind turbine which may be subjected to direct lightning strikes, and LPZ 0_B , namely the parts of a wind turbine which are protected from direct lightning strikes by external air-termination systems or air-termination systems integrated in parts of a wind turbine (for example in the rotor blade). According to the IEC 61400-24 (EN 61400-24) standard, the rolling sphere method may not be used for the rotor blade itself. For this reason, the design of the air-termination system should be tested according to subsection 8.2.3 of the IEC 61400-24 (EN 61400-24) standard. **Figure 1** shows a typical application of the rolling sphere method, **Figure 4** the possible division of a wind turbine into different lightning protection zones. In this context, the division of a wind turbine into lightning protection zones depends on the design of the wind turbine. Therefore, the structure of the wind turbine should be observed. However, it is decisive that the lightning parameters which are injected into LPZ 0_A from the outside are reduced by suitable shielding measures and surge protective devices at all zone boundaries so that there is no interference with the electrical and electronic devices and systems inside a wind turbine.

Shielding measures

The nacelle should be designed as a closed metal shield. Thus, a volume with an electromagnetic field that is considerably lower than the field outside the wind turbine is generated in the nacelle. In accordance with IEC 61400-24 (EN 61400-24), a tubular steel tower, which is frequently used for large wind turbines, can be regarded as an almost perfect Faraday cage for electromagnetic shielding. In case of concrete hybrid towers, the function of the galvanic cage must be ensured by reinforcing steel as well as the earthing and electrical connection of the individual components. The switchgear and control cabinets in the nacelle and, if any, in the operations building should also be made of metal. The connecting cables should

Lightning and surge protection for wind turbines

White Paper

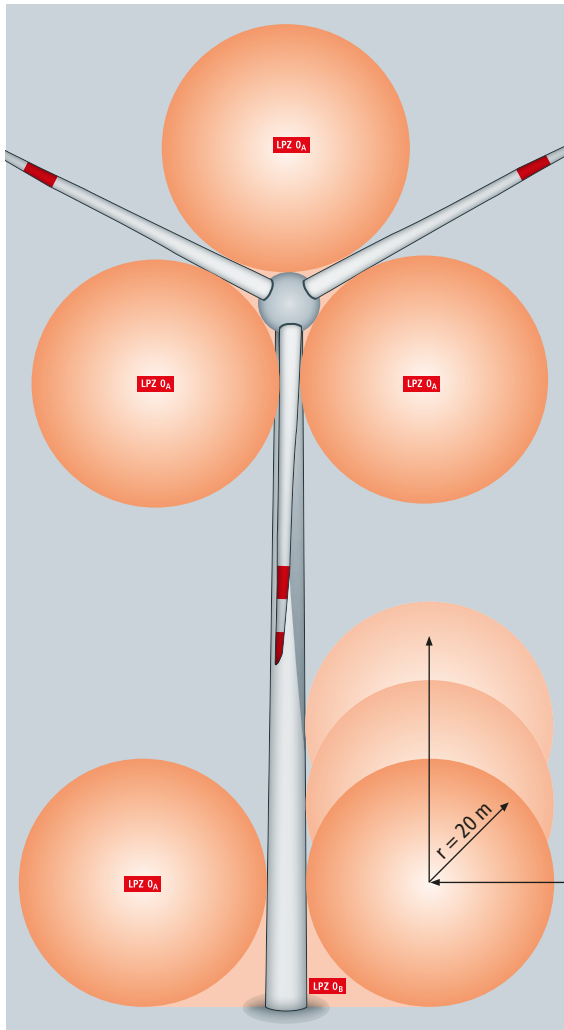

Figure 1 Rolling sphere method

feature an external shield that is capable of carrying lightning currents.

Shielded cables are only resistant to EMC interference if the shields are connected to the equipotential bonding system at both ends. The shields must be contacted by means of fully (360°) contacting terminals to prevent EMC-incompatible, long connecting cables in the wind turbine.

Magnetic shielding and cable routing should be performed as per section 4 of IEC 62305-4 (EC 62305-4). For this reason, the general guidelines for an EMC-compatible installation practice according to IEC/TR 61000-5-2 should be observed.

Shielding measures include, for example:

- ➔ Installation of a metal braid on GRP-coated nacelles

- ➔ Metal tower
- ➔ Metal switchgear cabinet
- ➔ Metal control cabinets
- ➔ Lightning current carrying, shielded connecting cables (metal cable duct, shielded pipe or the like)
- ➔ Cable shielding

External lightning protection measures

These include:

- ➔ Air-termination and down-conductor systems in the rotor blades
- ➔ Air-termination systems for protecting nacelle superstructures, the nacelle and the hub
- ➔ Using the tower as an air-termination system and down conductor
- ➔ Earth-termination system consisting of a foundation earth electrode and a ring earth electrode

The function of an external lightning protection system (LPS) is to intercept direct lightning strikes including lightning strikes to the tower of a wind turbine and to discharge the lightning current from the point of strike to the ground. An external lightning protection system is also used to distribute the lightning current in the ground without causing thermal or mechanical damage or dangerous sparking which may lead to fire or explosion and endanger people.

The rolling sphere method can be used to determine potential points of strike for a wind turbine (except for the rotor blades) (**Figure 1**). For wind turbines, the recommendation is to use class of LPS I. Therefore, a rolling sphere with a radius $r = 20$ m is rolled over the wind turbine to determine the points of strike. Air-termination systems are required where the sphere touches the wind turbine (potential points of strike).

The nacelle construction should be integrated in the lightning protection system to ensure that lightning strikes to the nacelle hit either natural metal parts that are capable of withstanding this stress or an air-termination system designed for this purpose.

GRP-coated nacelles or the like should be fitted with an air-termination system and down conductors forming a cage around the nacelle (metal braid). The air-termination system including the bare conductors in this cage should be capable of withstanding lightning strikes according to the relevant lightning protection level. Other conductors in the Faraday cage should be designed in such a way that they can withstand the amount of lightning current to which they may be subjected.

The IEC 61400-24 (EN 61400-24) standard requires that air-termination systems for protecting measurement equipment, etc. mounted outside the nacelle be designed in compliance with the general requirements of IEC 62305-3 (EN 62305-3)

Lightning and surge protection for wind turbines

White Paper



and that down conductors be connected to the cage described above.

Natural components made of conductive materials which are permanently installed in/on a wind turbine and remain unchanged (e.g., lightning protection system of the rotor blades, bearings, mainframes, hybrid tower) may be integrated in the LPS. When wind turbines consist of a metal construction, it can be assumed that they fulfil the requirements for an external lightning protection system of class of LPS I according to IEC 62305 (EN 62305).

This requires that the lightning strike be safely intercepted by the lightning protection system of the rotor blades so that it can be discharged to the earth-termination system via the natural components such as bearings, mainframes, the tower and /or bypass systems (e.g., open spark gaps, carbon brushes).

Air-termination system/ down conductor

As can be seen in **Figure 1**, the

- ➔ Rotor blades,
- ➔ Nacelle including superstructures (**Figure 2 and 4**),
- ➔ Rotor hub and
- ➔ Tower of the wind turbine

may be hit by lightning. If they are capable of safely intercepting the maximum lightning impulse current of 200 kA and discharging it to the earth-termination system, they can be used as natural components of the air-termination system of the wind turbine's external lightning protection system.

A metallic receptor, which represents a defined point of strike for flashes, is frequently attached to the tip of the GRP blade to protect the rotor blades from lightning strikes. A down conductor is routed from the receptor to the blade root. In case of a lightning strike, it can be assumed that lightning hits the blade tip (receptor) and then travels through the down conductor inside the blade via the nacelle and the tower to the earth-termination system.

Earth-termination system

The earth-termination system of a wind turbine must perform several functions such as personal protection, EMC protection and lightning protection. Materials, configurations and minimum cross-sectional areas can be taken from Table 6 of IEC 62305-3.

An effective earth-termination system (**Figure 3**) is essential to distribute lightning currents and to prevent the wind turbine from being destroyed. Moreover, the earth-termination system must protect people and animals against electric shock. In case of a lightning strike, the earth-termination system must discharge high lightning currents to the ground and distribute them in the ground without causing dangerous thermal and/or electrodynamic effects.

In general, it is important to install an earth-termination system for a wind turbine which is used to protect the wind turbine against lightning strikes and to earth the power supply system.

Note: Electrical high-voltage regulations such as CENELEC HD 637 S1 or applicable national standards describe how to design an earth-termination system to prevent high touch and step voltages caused by short-circuits in high or medium-voltage systems. With regard to the protection of human life, the IEC 61400-24 (EN 61400-24) standard refers to IEC/TS 60479-1 and IEC 60479-4.

Arrangement of earth electrodes

The IEC 62305-3 (EN 62305-3) standard describes two basic types of earth electrode arrangements for wind turbines:

Type A: According to the informative Annex I of IEC 61400-24 (EN 61400-24), this arrangement cannot be used for wind turbines themselves, but for adjoining buildings (for example, buildings containing measurement equipment or office sheds for the wind farm). Type A earth electrode arrangements consist of horizontal or vertical earth electrodes connected to the building by at least two down conductors.

Type B: According to the informative Annex I of IEC 61400-24 (EN 61400-24), type B earth electrodes must be used for wind turbines. They either consist of a buried external ring earth electrode and/or a foundation earth electrode. Ring earth electrodes and metal parts in the foundation must be connected to the tower construction.

In any case, the reinforcement of the tower foundation should be integrated in the earth-termination system of a wind turbine.



Figure 2 Example of an air-termination system for the weather station and the aircraft warning light

Lightning and surge protection for wind turbines

White Paper



To ensure an earth-termination system ranging over as large an area as possible, the earth-termination system of the tower base and the operations building should be connected by means of a meshed earth electrode network. Corrosion-resistant ring earth electrodes (made of stainless steel (V4A), e.g. material No. AISI / ASTM 316 Ti) with potential control prevent excessive step voltages in case of a lightning strike and must be installed around the tower base to ensure personal protection (**Figure 3**).

Foundation earth electrodes

Foundation earth electrodes make technical and economic sense and are required in the German Technical Connection Conditions (TAB) published by German distribution network operators. They are part of the electrical installation and fulfil

essential safety functions. For this reason, they must be installed by or under the supervision of an electrician.

The metals used for earth electrodes must comply with the materials listed in Table 7 of IEC 62305-3 (EN 62305-3). The corrosion behaviour of metal in the ground must be observed at all times.

Foundation earth electrodes should be made of galvanised or non-galvanised (round or strip) steel. Round steel must have a minimum diameter of 10 mm, while strip steel must have minimum dimensions of 30 mm x 3.5 mm. This material must be covered with an at least 5 cm thick layer of concrete (corrosion protection). The foundation earth electrode must be connected to the main earthing busbar in the wind turbine. Corrosion-resistant connections must be established via fixed earthing

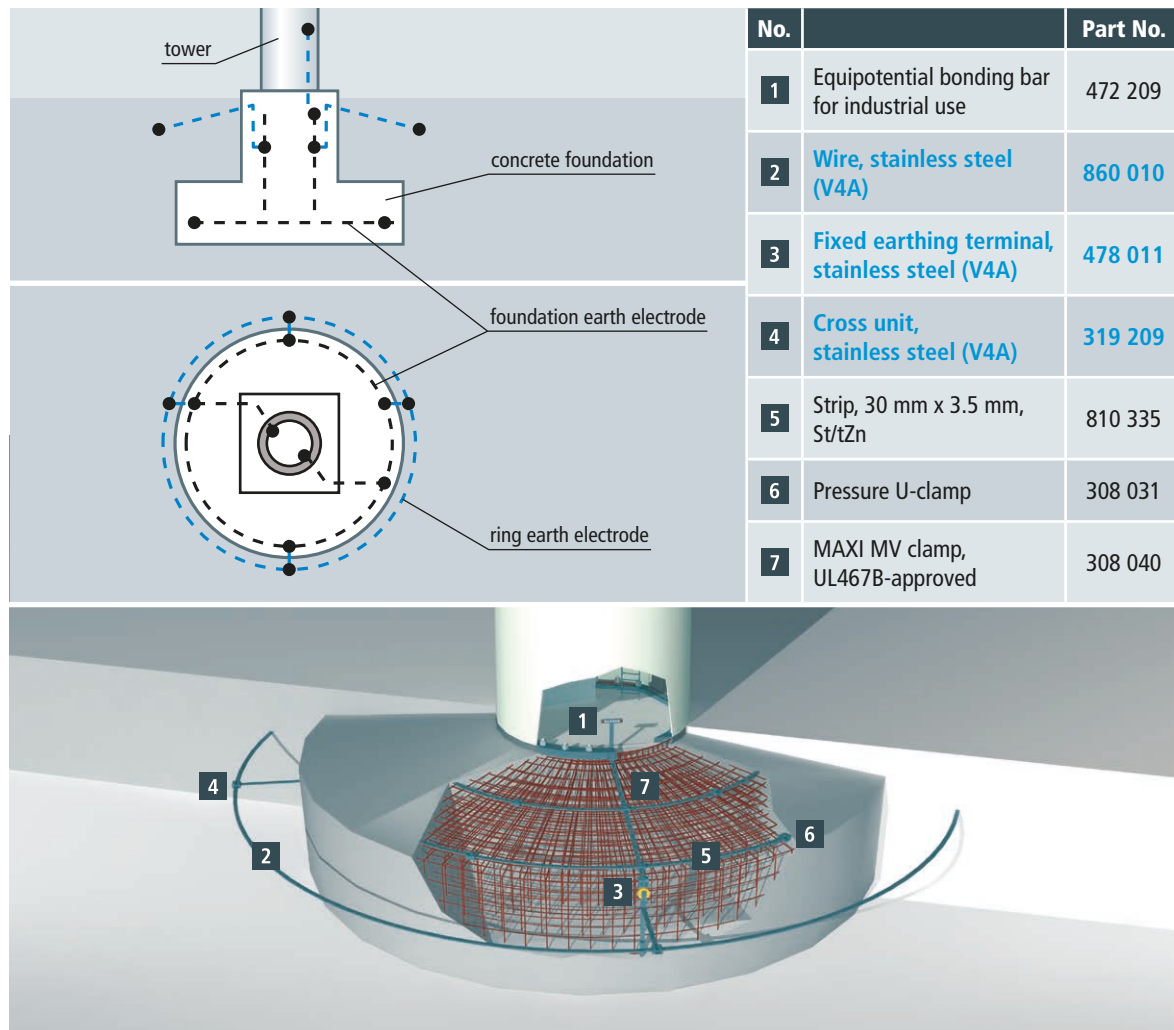

Figure 3 Earth-termination system of a wind turbine

Lightning and surge protection for wind turbines

White Paper



terminals or terminal lugs made of stainless steel (V4A). Moreover, a ring earth electrode made of stainless steel (V4A) must be installed in the ground.

Internal lightning protection measures

- ➔ Earthing and equipotential bonding measures
- ➔ Spatial shielding and separation distance
- ➔ Cable routing and cable shielding
- ➔ Installation of coordinated surge protective devices

Protection of the lines at the transition from LPZ 0_A to LPZ 1 and higher

To ensure safe operation of electrical and electronic devices, the boundaries of the lightning protection zones (LPZs) must be shielded against field-based interference and must be protected against conducted interference (**Figures 4 and 5**). To this end, surge protective devices that are capable of discharging high partial lightning currents without destruction must be installed at the transition from LPZ 0_A to LPZ 1 (also referred to as lightning equipotential bonding). These surge protective devices are referred to as type 1 lightning current arresters and are tested by means of impulse currents of 10/350 μ s waveform. At the transition from LPZ 0_B to LPZ 1 and higher, only low-energy impulse currents caused by voltages induced on the system or surges generated in the system must be coped with. These surge protective devices are referred to as type 2 surge arresters and are tested by means of impulse currents of 8/20 μ s waveform.

According to the lightning protection zone concept, all incoming cables and lines must be integrated in the lightning equipotential bonding system by means of type 1 lightning current arresters at the boundary from LPZ 0_A to LPZ 1 or from LPZ 0_A to LPZ 2. This affects both power supply and communication lines. An additional local equipotential bonding system where all cables and lines entering this boundary are integrated must be established for every further zone boundary within the volume to be protected. Type 2 surge arresters must be installed at the transition from LPZ 0_B to LPZ 1 and from LPZ 1 to LPZ 2, whereas type 3 surge arresters must be provided at the transition from LPZ 2 to LPZ 3. The function of type 2 and type 3 surge arresters is to further reduce the residual interference of the upstream protection stages and to limit the surges induced on the wind turbine or generated in the wind turbine.

Selection of SPDs based on the voltage protection level (U_p) and the immunity of the equipment

To describe the required voltage protection level U_p in an LPZ, the immunity levels of the equipment located in an LPZ must be defined, e.g., for power lines and connection of equipment according to IEC 61000-4-5 (EN 61000-4-5) and IEC 60664-1

(EN 60664-1), for telecommunication lines and connection of equipment according to IEC 61000-4-5 (EN 61000-4-5), ITU-T K.20 and ITU-T K.21 and for other lines and connection of equipment according to the manufacturer's instructions.

Manufacturers of electrical and electronic components or devices should be able to provide the required information on the immunity level according to the EMC standards. If this is not the case, the wind turbine manufacturer should perform tests to determine the immunity level. The specific immunity level of components in an LPZ directly defines the voltage protection level required at the LPZ boundaries. The immunity of a system must be proven, where applicable, with all SPDs installed and the equipment to be protected.

Protection of power supply systems

The transformer of a wind turbine may be housed at different locations (in a separate distribution station, in the tower base, in the tower, in the nacelle). In case of large wind turbines, for example, the unshielded 20 kV cable in the tower base is routed to the medium-voltage switchgear installation consisting of a vacuum circuit breaker, mechanically locked selector switch disconnecter, outgoing earthing switch and protective relay. The medium-voltage cables are routed from the medium voltage switchgear installation in the tower of the wind turbine to the transformer which may be situated in the tower base or in the nacelle (**Figure 4**). The transformer feeds the control cabinet in the tower base, the switchgear cabinet in the nacelle and the pitch system in the hub by means of a TN-C system (L1, L2, L3, PEN conductor). The switchgear cabinet in the nacelle supplies the electrical equipment in the nacelle with an a.c. voltage of 230/400 V.

According to IEC 60364-4-44, all pieces of electrical equipment installed in a wind turbine must have a specific rated impulse withstand voltage according to the nominal voltage of the wind turbine (see IEC 60664-1 (EN 60664-1): Table 1, insulation coordination). This means that the surge arresters to be installed must have at least the specified voltage protection level according to the nominal voltage of the wind turbine. Surge arresters used to protect the 400/690 V supply must have a minimum voltage protection level $U_p \leq 2.5$ kV, whereas surge arresters used to protect the 230/400 V supply must have a voltage protection level $U_p \leq 1.5$ kV to ensure protection of sensitive electrical / electronic equipment (**Figures 6 and 7**). Surge protective devices shall be capable of discharging lightning currents of 10/350 μ s waveform without destruction and shall have a voltage protection level of $U_p \leq 2.5$ kV (**Figure 8**).

Protection of the transformer infeed

The medium-voltage transformer infeed is protected by DEHN-mid medium-voltage arresters which must be adapted to the system configuration and voltage of the medium-voltage system (**Figure 9**).

Lightning and surge protection for wind turbines

White Paper

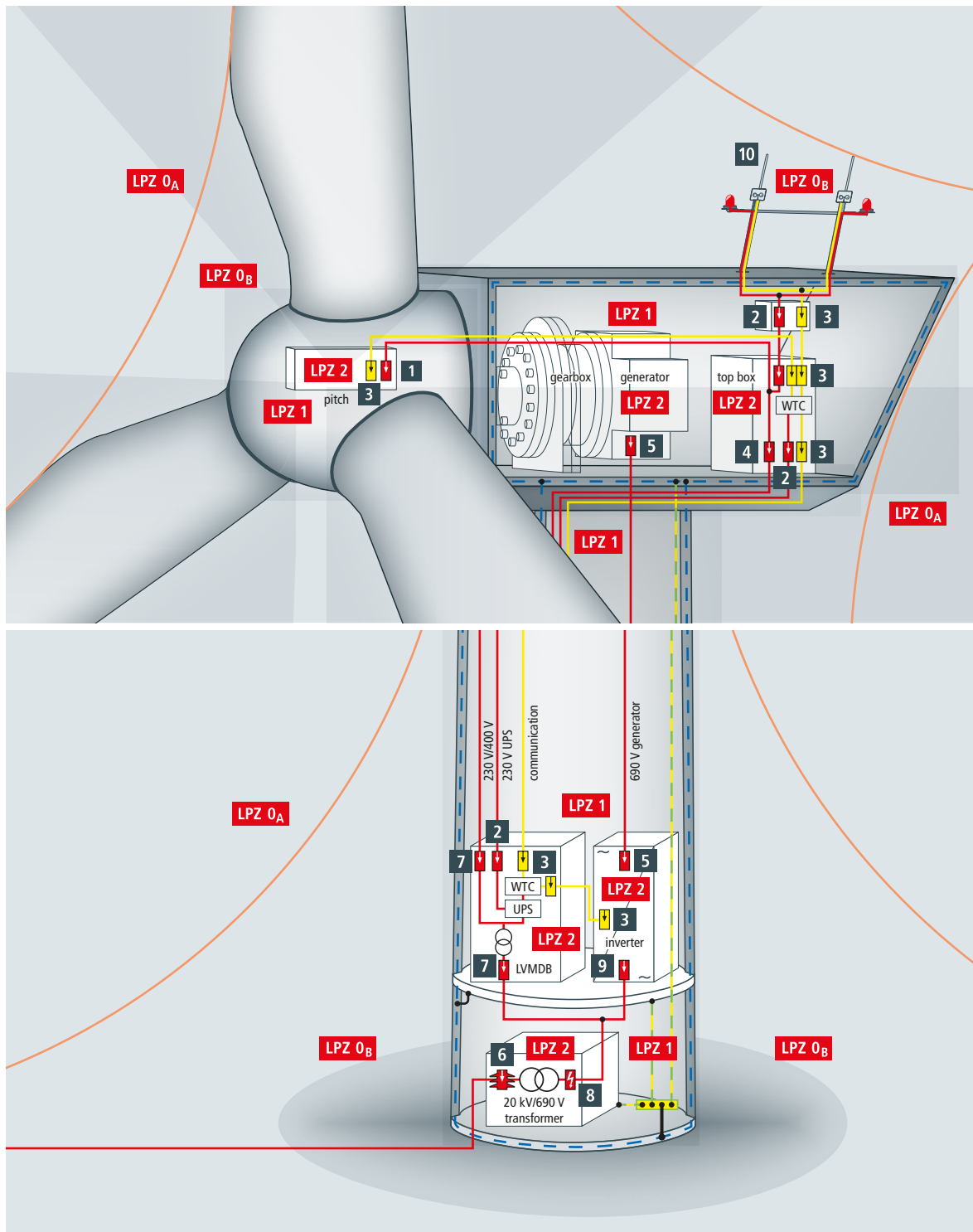

Figure 4 Lightning and surge protection for a wind turbine

Lightning and surge protection for wind turbines

White Paper



No. in Fig. 4	Area to be protected	Surge protective device	Part No.
1	Voltage supply of the hub Signal lines between the nacelle and the hub	DEHNguard TN 275 FM	952 205
		BLITZDUCTOR XT BE 24 *	920 324
		DENHpatch DPA M CAT6 RJ45S48	929 121
2	Protection of the aircraft warning light	DEHNguard M TN 275 FM	952 205
3	Protection of bus lines, signal and control lines, Ethernet	BLITZDUCTOR XT ML4 BE 24 *	920 324
		BLITZDUCTOR XT ML2 BE S 24 *	920 224
4	Control cabinet in the nacelle 230/400 V voltage supply	DEHNguard M TNC 275 FM	952 305
		DEHNguard M TNC CI 275 FM	952 309
5	Protection of the generator	Stator	DEHNguard M WE 600 FM
		Rotor (double fed induction motor)	DEHNguard SE H 1000 VA FM
6	Protection of the transformer	DEHNmid DMI 9 10 1	990 003
		DEHNmid DMI 36 10 1	990 013
7	Voltage supply of the control cabinet in the tower base, 230/400 V TN-C system	DEHNguard M TNC 275 FM	952 305
		DEHNguard M TNC CI 275 FM	952 309
8	Main incoming supply, 400/690 V TN system	3x DEHNbloc M 1 440 FM	961 145
9	Protection of the inverter	DEHNguard M WE 600 FM	952 307
10	Protection of the nacelle superstructures	Air-termination rods	103 449
		Pipe clamp for air-termination rods	540 105

Table 1 Protection of a wind turbine (lightning protection zone concept according to Figure 4) * associated base part: BXT BAS, Part No. 920 300

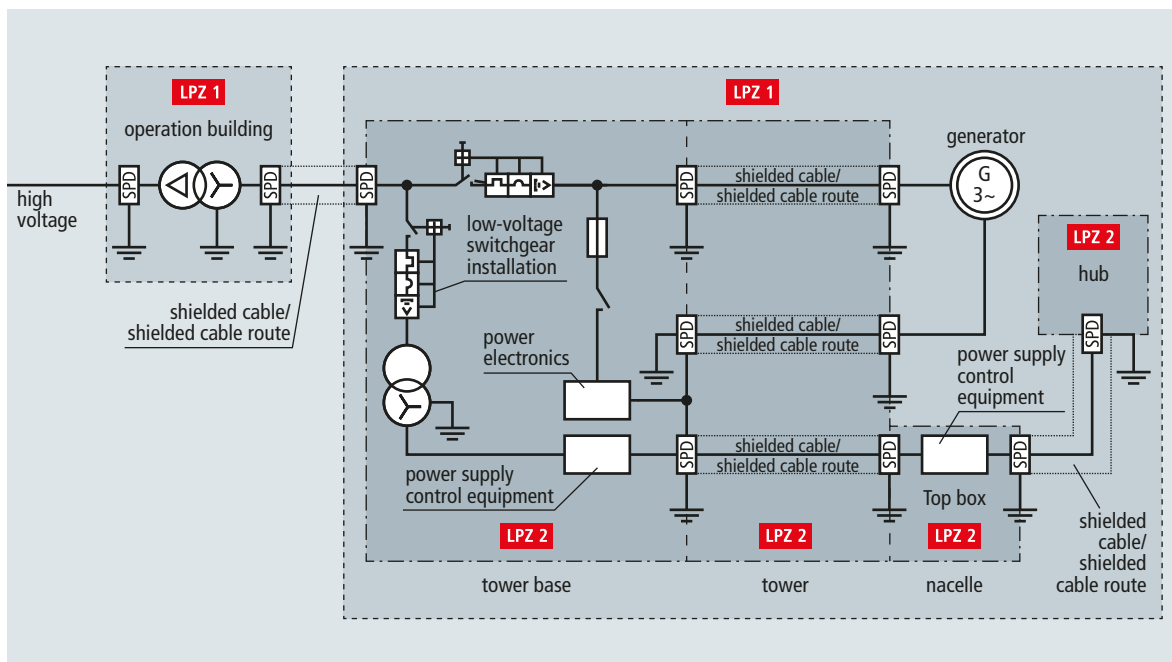

Figure 5 Example of arresters installed at the zone boundaries of a wind turbine

Lightning and surge protection for wind turbines

White Paper



Figure 6 Modular type 2 surge arrester for protecting the 230/400 V supply

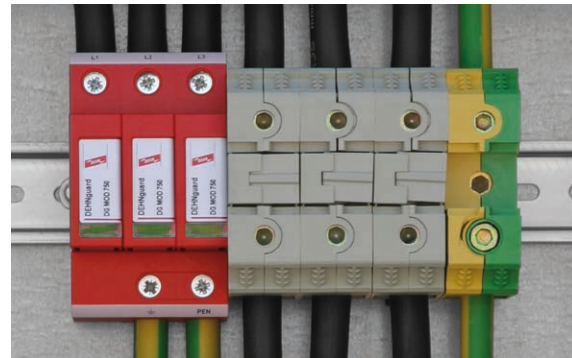

Figure 7 Protection of the generator / converter



Figure 8 Coordinated type 1 surge arrester



Figure 9 DEHNmid medium-voltage arresters installed in a transformer for wind turbines

230/400 V supply

Type 2 surge arresters, for example, DEHNGuard M TNC 275 CI FM, should be used to protect the voltage supply of the control cabinet in the tower base, the switchgear cabinet in the nacelle and the pitch system in the hub by means of a 230/400 V TN-C system (Figure 6).

Protection of the aircraft warning light

The aircraft warning light on the sensor mast in LPZ 0_B should be protected by a type 2 surge arrester at the relevant zone transitions (LPZ 0_B → 1, LPZ 1 → 2) (Table 1). Depending on the system, components of the DEHNGuard series (low voltage) and/or BLITZDUCTOR family, for example, can be used for extra low voltage/signal lines.

400/690 V system

Coordinated single-pole lightning current arresters with a high follow current limitation for the 400/690 V systems, for example DEHNbloc M 1 440 FM (Figure 8), must be installed to protect the 400/690 V transformer, inverters, mains filters

and the measurement equipment. It must be ensured at the frequency converter that the arresters are dimensioned for the maximum voltage peaks, which are higher than in case of pure sinusoidal voltages. In this context, surge arresters with a nominal voltage of 600 V and $U_{mov} = 750$ V have proven their worth. The DEHNGuard DG M WE 600 FM (Figure 7) arresters can be installed at both sides of the converter (grid and machine side) and on the generator. Only if doubly-fed induction generators are used, must an arrester combination with an increased electric strength be used on the rotor side.

For this purpose, it is advisable to install the high-capacity arrester DEHNGuard SE H 1000 VA FM designed for continuous operating voltages of up to 1000 V and discharge currents up to 40 kA (8/20 μ s). The internal series connection of a varistor and gas discharge tube ensures that the SPD does not activate in the event of temporary overvoltages up to 2200 V_{peak}. Nevertheless, a very low protection level $U_p \leq 5$ kV is achieved (Figure 10). A suitable solution is also available for larger voltage peaks of up to 3 kV (with a protection level of ≤ 10 kV) in the form of a 3+1 Neptune circuit consisting of

Lightning and surge protection for wind turbines

White Paper



Figure 10 DEHNGuard SE H 1000 VA FM type 2 arrester for voltages up to 1000 V

three DEHNGuard arresters and a spark-gap-based arrester for potential separation.

Surge arresters for information technology systems

Surge arresters for protecting electronic equipment in telecommunication and signalling networks against the indirect and direct effects of lightning strikes and other transients are described in IEC 61643-21 (EN 61643-21) and are installed at the zone boundaries in conformity with the lightning protection zone concept (Figure 4, Table 1). Multi-stage arresters must be designed without blind spots, in other words it must be ensured that the different protection stages are coordinated with one another. Otherwise not all protection stages will be activated, thus causing faults in the surge protective device. Glass fibre cables are frequently used for routing information technology lines into a wind turbine and for connecting the control cabinets in the tower base to the nacelle. Shielded copper cables are used to connect the actuators and sensors with the control cabinets. Since interference by an electromagnetic environment is excluded, the glass fibre cables do not need to be protected by surge arresters unless they have a metal sheath which must be integrated in the equipotential bonding system either directly or by means of surge protective devices.

In general, the following shielded signal lines connecting the actuators and sensors with the control cabinets must be protected by surge protective devices:

- ➔ Signal lines of the weather station and aircraft warning light on the sensor mast
- ➔ Signal lines routed between the nacelle and the pitch system in the hub
- ➔ Signal lines for the pitch system



Figure 11 Protection of wind measurement equipment (anemometer)

- ➔ Signal lines to the inverter
- ➔ Signal lines to the fire extinguishing system

Signal lines of the weather station

The signal lines (4–20 mA interfaces) between the sensors of the weather station and the switchgear cabinet are routed from LPZ 0_B to LPZ 2 and can be protected by means of BLITZDUCTOR XT ML4 BE 24 or BLITZDUCTOR XT ML2 BE S 24 combined arresters (Figure 11). These space-saving combined arresters with LifeCheck feature protect two or four single cores sharing a common reference potential as well as unbalanced interfaces and allow direct or indirect shield earthing. Shield terminals with a flexible spring element for permanent low impedance shield contact with the protected and unprotected side of the arrester are used for earthing the shield. If the wind measurement equipment (anemometer) is fitted with a heating system, BLITZDUCTOR BVT ALD 36 combined arresters may be installed. These DIN rail mounted combined arresters are energy-coordinated with the surge protective devices of unearthed DC power supply systems (Figure 11).

Signal lines for the pitch system

A universal DEHNpatch DPA M CLE RJ45B 48 surge arrester can be used if information between the nacelle and the pitch system is exchanged via 100 MB Ethernet data lines. This arrester is designed for Industrial Ethernet and similar applications in structured cabling systems according to class E up to 250 MHz for all data services up to 48 V DC and protects four pairs (Figure 12).

Alternatively, a DEHNpatch DPA M CAT6 RJ45S 48 arrester can be used to protect the 100 MB Ethernet data lines. This surge protective device is a prewired standard patch cable with integrated surge arrester.

Lightning and surge protection for wind turbines

White Paper



Whether the signal lines for the pitch system must be protected by surge protective devices depends on the sensors used which may have different parameters depending on the manufacturer. If, for example, sensors supplied with 24 V DC or lower voltages are used, BLITZDUCTOR BXT ML4 BE 24 surge arresters are ideally suited for protecting these signal lines. These arresters can be installed in conformity with the lightning protection zone concept at the boundaries from LPZ 0_A to LPZ 2 and higher. Surge protective devices should be installed on both sides, namely in the pitch system and in the controller.

Condition monitoring

The availability of wind turbines, especially that of offshore wind turbines, is gaining increased importance. Therefore, lightning current and surge arresters must be monitored for signs of pre-damage (condition monitoring).

The specific use of condition monitoring allows one to plan service work and thus reduce costs.

With the BLITZDUCTOR XT arresters for information technology systems DEHN offers the integrated LifeCheck feature – a simple and ideal system for monitoring arresters to detect pre-damage at an early stage and plan the exchange of the relevant arrester for the next service interval. LifeCheck permanently monitors the status of the arresters free of potential since the LifeCheck status is read out via contactless RFID technology. Like an early warning system, LifeCheck reliably detects imminent electrical or thermal overload of the protection components. A stationary condition monitoring system allows condition-based maintenance of 10 BLITZDUCTOR XT arresters. Two systems are available:

1. DRC MCM XT (**Figure 12**) – Compact DIN rail mounted multiple condition monitoring system:
 - ➔ Condition monitoring of arresters with LifeCheck



Figure 12 Example of surge protective devices in a pitch system

- ➔ Cascaded system permanently monitors up to 150 arresters (600 signal cores)
 - ➔ Minimal wiring
 - ➔ Remote signalling via RS485 or remote signalling contacts (1 break and 1 make contact)
2. DRC SCM XT – Single condition monitoring system ideally suited for small-sized wind turbines with a maximum of ten arresters:
 - ➔ Condition monitoring of arresters with LifeCheck
 - ➔ Monitoring of up to 10 arresters (40 signal cores)
 - ➔ Minimal wiring
 - ➔ Remote signalling via remote signalling contact (1 break contact)

As is the case with the condition monitoring systems of the BLITZDUCTOR XT series, all arrester systems of the DEHNguard or DEHNblock series with the name affix "FM" can be optionally monitored via a floating contact. In case of DEHNguard arresters with the name affix "LI" (Lifetime Indication), the visual display indicates three operating states, namely yellow (end of service life), green (fully functional) and red (faulty). If the yellow indicator flag appears, the module has reached about 80% of its service life. In addition to the visual indication on the module itself, this signal to replace the arrester in the next service interval is also transmitted to the turbine controller via the remote signalling contact.

Laboratory tests according to IEC-61400-24

IEC 61400-24 (EN 61400-24) describes two basic methods of performing system-level immunity tests for wind turbines:

- ➔ When performing impulse current tests under operating conditions, impulse currents or partial lightning currents are injected into the individual lines of a control system

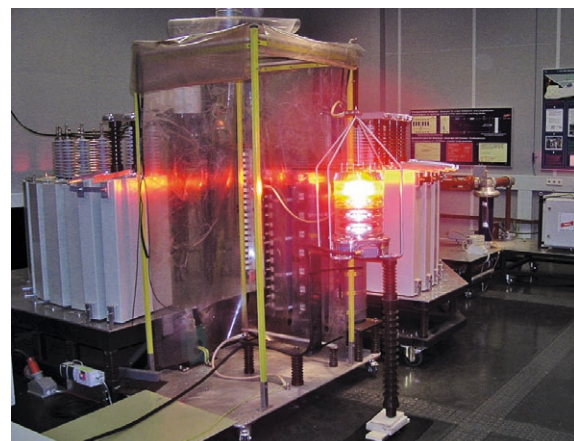

Figure 13 Customer-specific testing in the impulse current laboratory

Lightning and surge protection for wind turbines

White Paper



while mains voltage is present. Thus, the equipment to be protected including all SPDs is subjected to an impulse current test.

- ➔ The second test method simulates the electromagnetic effects of the LEMP. To this end, the full lightning current is injected into the structure which discharges the lightning current and the behaviour of the electrical system is analysed while simulating the cabling under operating conditions as realistically as possible. The lightning current steepness is a decisive test parameter.

DEHN offers engineering and test services (**Figure 13**) for wind turbine manufacturers such as:

- ➔ Lightning current tests for bearings and gearboxes of the mechanical drive string
- ➔ High-current tests for the receptors and down conductors of rotor blades
- ➔ System-level immunity tests for important control systems such as pitch systems, wind sensors or aircraft warning-lights
- ➔ Testing of customer-specific connection units

Such system tests should be carried out for important control systems in accordance with IEC 61400-24 (EN 61400-24).

DEHNbloc Maxi

DBM 1 440 FM (961 145)

- Extremely high lightning current discharge capacity
- High follow current extinction and limitation due to RADAX Flow technology
- Directly coordinated with DEHNguard surge protective devices without additional cable length



Figure without obligation

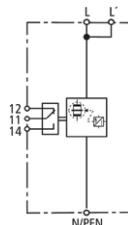

Basic circuit diagram DBM 1 440 FM

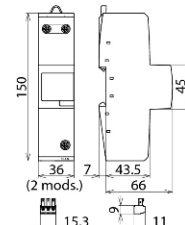

Dimension drawing DBM 1 440 FM

Coordinated single-pole lightning current arrester with high follow current limitation for $U_c = 440$ V.

Type Part No.	DBM 1 440 FM 961 145
SPD according to EN 61643-11 / IEC 61643-11	type 1 / class I
Nominal voltage (a.c.) (U_N)	400 V
Max. continuous operating voltage (a.c.) (U_C)	440 V
Lightning impulse current (10/350 μ s) (I_{imp})	35 kA
Specific energy (W/R)	306.25 kJ/ohms
Nominal discharge current (8/20 μ s) (I_n)	35 kA
Voltage protection level (U_P)	≤ 2.5 kV
Follow current extinguishing capability (a.c.) (I_f)	50 kA _{rms}
Follow current limitation / Selectivity	no tripping of a 32 A gG fuse up to 50 kA _{rms} (prosp.)
Response time (t_A)	≤ 100 ns
Max. backup fuse (L) up to $I_K = 50$ kA _{rms} ($t_a \leq 0.2$ s)	500 A gG
Max. backup fuse (L) up to $I_K = 50$ kA _{rms} ($t_a \leq 5$ s)	250 A gG
Max. backup fuse (L-L')	125 A gG
Temporary overvoltage (TOV) (U_T) – Characteristic	760 V / 120 min. – withstand
Operating temperature range (parallel connection) (T_{UP})	-40 °C ... +80 °C
Operating temperature range (series connection) (T_{US})	-40 °C ... +60 °C
Operating state / fault indication	green / red
Number of ports	1
Cross-sectional area (L, L', N/PEN) (min.)	10 mm ² solid / flexible
Cross-sectional area (L, N/PEN) (max.)	50 mm ² stranded / 35 mm ² flexible
Cross-sectional area (L') (max.)	35 mm ² stranded / 25 mm ² flexible
For mounting on	35 mm DIN rails acc. to EN 60715
Enclosure material	thermoplastic, red, UL 94 V-0
Place of installation	indoor installation
Degree of protection	IP 20
Capacity	2 module(s), DIN 43880
Approvals	UL, CSA
Type of remote signalling contact	changeover contact
Switching capacity (a.c.)	250 V / 0.5 A
Switching capacity (d.c.)	250 V / 0.1 A; 125 V / 0.2 A; 75 V / 0.5 A
Cross-sectional area for remote signalling terminals	max. 1.5 mm ² solid / flexible
Extended technical data:	Use in switchgear installations with prospective short-circuit currents of more than 50 kA _{rms} (tested by the German VDE)
– Max. prospective short-circuit current	100 kA _{rms} (220 kA _{peak})
– Limitation / Extinction of mains follow currents	up to 100 kA _{rms} (220 kA _{peak})
– Max. backup fuse (L) up to $I_K = 100$ kA _{rms} ($t_a \leq 0.2$ s)	500 A gG
– Max. backup fuse (L) up to $I_K = 100$ kA _{rms} ($t_a \leq 5$ s)	250 A gG
Weight	520 g
Customs tariff number (Comb. Nomenclature EU)	85363090
GTIN	4013364116276
PU	1 pc(s)

DEHNguard

DG SE H 1000 VA FM (952 940)

- Prewired and universal single-pole surge arrester comprising a base part and a plug-in protection module
- Leakage-current-free series connection of a varistor and a spark gap in the plug-in protection module
- Easy replacement of protection modules without tools due to module locking system (vibration and shock-tested according to EN 60068-2)



Figure without obligation

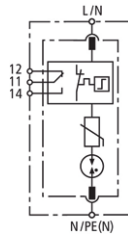

Basic circuit diagram DG SE H 1000 VA FM

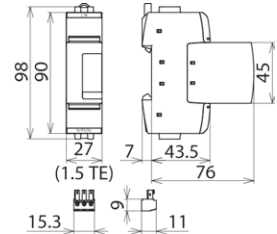

Dimension drawing DG SE H 1000 VA FM

Pluggable single-pole surge arrester comprising a base part and a plug-in protection module; with floating remote signalling contact.

Type	DG SE H 1000 VA FM
Part No.	952 940
SPD according to EN 61643-11 / IEC 61643-11	type 2 / class II
Energy coordination with terminal equipment (≤ 10 m)	type 2 + type 3
Nominal voltage (a.c.) (U_N)	690 V (50 / 60 Hz)
Max. continuous operating voltage (a.c.) (U_C)	1000 V (50 / 60 Hz)
Nominal discharge current (8/20 μ s) (I_n)	15 kA
Max. discharge current (8/20 μ s) (I_{max})	40 kA
Voltage protection level (U_P)	≤ 5 kV
Response time (t_A)	≤ 25 ns
Max. mains-side overcurrent protection	100 A gG
Short-circuit withstand capability for max. mains-side overcurrent protection (I_{SCCR})	25 kA _{rms}
Temporary overvoltage (TOV) (U_T) – Characteristic	1550 V / 5 sec. – withstand
Temporary overvoltage (TOV) (U_T) – Characteristic	1320 V / 120 min. – withstand
Operating temperature range (T_U)	-40 °C ... +80 °C
Operating state / fault indication	green / red
Number of ports	1
Cross-sectional area (min.)	1.5 mm ² solid / flexible
Cross-sectional area (max.)	35 mm ² stranded / 25 mm ² flexible
For mounting on	35 mm DIN rails acc. to EN 60715
Enclosure material	thermoplastic, red, UL 94 V-0
Place of installation	indoor installation
Degree of protection	IP20
Capacity	1.5 module(s), DIN 43880
Approvals	UL
Type of remote signalling contact	changeover contact
Switching capacity (a.c.)	250 V / 0.5 A
Switching capacity (d.c.)	250 V / 0.1 A; 125 V / 0.2 A; 75 V / 0.5 A
Cross-sectional area for remote signalling terminals	max. 1.5 mm ² solid / flexible
Supplementary data:	-----
– Sparkover voltage gas discharge tube (U_{agmin})	2200 V
Weight	207 g
Customs tariff number (Comb. Nomenclature EU)	85363030
GTIN	4013364308329
PU	1 pc(s)

DEHNguard

DG M TN 275 FM (952 205)

- Prewired complete unit consisting of a base part and plug-in protection modules
- High discharge capacity due to heavy-duty zinc oxide varistors / spark gaps
- High reliability due to "Thermo Dynamic Control" SPD monitoring device



Figure without obligation

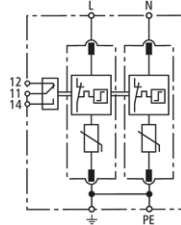

Basic circuit diagram DG M TN 275 FM

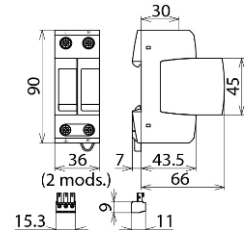

Dimension drawing DG M TN 275 FM

Modular surge arrester for use in single-phase TN systems; with floating remote signalling contact.

Type	DG M TN 275 FM
Part No.	952 205
SPD according to EN 61643-11 / IEC 61643-11	type 2 / class II
Energy coordination with terminal equipment (≤ 10 m)	type 2 + type 3
Nominal voltage (a.c.) (U_N)	230 V (50 / 60 Hz)
Max. continuous operating voltage (a.c.) (U_C)	275 V (50 / 60 Hz)
Nominal discharge current (8/20 μ s) (I_n)	20 kA
Max. discharge current (8/20 μ s) (I_{max})	40 kA
Voltage protection level [L-PE]/[N-PE] (U_P)	≤ 1.5 / ≤ 1.5 kV
Voltage protection level [L-PE] / [N-PE] at 5 kA (U_P)	≤ 1 / ≤ 1 kV
Response time (t_A)	≤ 25 ns
Max. mains-side overcurrent protection	125 A gG
Short-circuit withstand capability for max. mains-side overcurrent protection (I_{SCCR})	50 kA _{rms}
Temporary overvoltage (TOV) (U_T) – Characteristic	335 V / 5 sec. – withstand
Temporary overvoltage (TOV) (U_T) – Characteristic	440 V / 120 min. – safe failure
Operating temperature range (T_U)	-40 °C ... +80 °C
Operating state / fault indication	green / red
Number of ports	1
Cross-sectional area (min.)	1.5 mm ² solid / flexible
Cross-sectional area (max.)	35 mm ² stranded / 25 mm ² flexible
For mounting on	35 mm DIN rails acc. to EN 60715
Enclosure material	thermoplastic, red, UL 94 V-0
Place of installation	indoor installation
Degree of protection	IP 20
Capacity	2 module(s), DIN 43880
Approvals	KEMA, VDE, UL
Type of remote signalling contact	changeover contact
Switching capacity (a.c.)	250 V / 0.5 A
Switching capacity (d.c.)	250 V / 0.1 A; 125 V / 0.2 A; 75 V / 0.5 A
Cross-sectional area for remote signalling terminals	max. 1.5 mm ² solid / flexible
Weight	232 g
Customs tariff number (Comb. Nomenclature EU)	85363030
GTIN	4013364108400
PU	1 pc(s)

DEHNguard

DG M TNC 275 FM (952 305)

- Prewired complete unit consisting of a base part and plug-in protection modules
- High discharge capacity due to heavy-duty zinc oxide varistors / spark gaps
- High reliability due to "Thermo Dynamic Control" SPD monitoring device



Figure without obligation

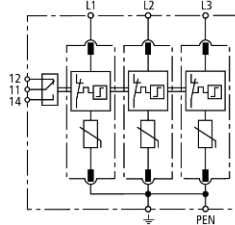

Basic circuit diagram DG M TNC 275 FM

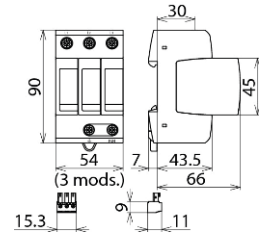

Dimension drawing DG M TNC 275 FM

Modular surge arrester for use in TN-C systems; with floating changeover contact.

Type	DG M TNC 275 FM
Part No.	952 305
SPD according to EN 61643-11 / IEC 61643-11	type 2 / class II
Energy coordination with terminal equipment (≤ 10 m)	type 2 + type 3
Nominal voltage (a.c.) (U_N)	230 / 400 V (50 / 60 Hz)
Max. continuous operating voltage (a.c.) (U_C)	275 V (50 / 60 Hz)
Nominal discharge current (8/20 μ s) (I_n)	20 kA
Max. discharge current (8/20 μ s) (I_{max})	40 kA
Voltage protection level (U_P)	≤ 1.5 kV
Voltage protection level at 5 kA (U_P)	≤ 1 kV
Response time (t_A)	≤ 25 ns
Max. mains-side overcurrent protection	125 A gG
Short-circuit withstand capability for max. mains-side overcurrent protection (I_{SCCR})	50 kA _{rms}
Temporary overvoltage (TOV) (U_T) – Characteristic	335 V / 5 sec. – withstand
Temporary overvoltage (TOV) (U_T) – Characteristic	440 V / 120 min. – safe failure
Operating temperature range (T_U)	-40 °C ... +80 °C
Operating state / fault indication	green / red
Number of ports	1
Cross-sectional area (min.)	1.5 mm ² solid / flexible
Cross-sectional area (max.)	35 mm ² stranded / 25 mm ² flexible
For mounting on	35 mm DIN rails acc. to EN 60715
Enclosure material	thermoplastic, red, UL 94 V-0
Place of installation	indoor installation
Degree of protection	IP 20
Capacity	3 module(s), DIN 43880
Approvals	KEMA, VDE, UL
Type of remote signalling contact	changeover contact
Switching capacity (a.c.)	250 V / 0.5 A
Switching capacity (d.c.)	250 V / 0.1 A; 125 V / 0.2 A; 75 V / 0.5 A
Cross-sectional area for remote signalling terminals	max. 1.5 mm ² solid / flexible
Weight	328 g
Customs tariff number (Comb. Nomenclature EU)	85363030
GTIN	4013364108448
PU	1 pc(s)

DEHNguard

DG M WE 600 FM (952 307)

- Prewired complete unit consisting of a base part and plug-in protection modules
- High discharge capacity due to heavy-duty zinc oxide varistors / spark gaps
- High reliability due to "Thermo Dynamic Control" SPD monitoring device



Figure without obligation

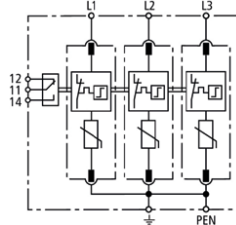

Basic circuit diagram DG M WE 600 FM

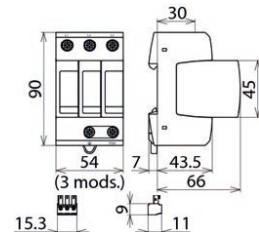

Dimension drawing DG M WE 600 FM

Modular three-pole surge arrester for use in wind turbines with a rated varistor voltage $U_{mov} = 750$ V a.c.; FM version with floating remote signalling contact.

Type	DG M WE 600 FM
Part No.	952 307
SPD according to EN 61643-11 / IEC 61643-11	type 2 / class II
Energy coordination with terminal equipment (≤ 10 m)	type 2 + type 3
Nominal voltage (a.c.) (U_N)	480 V (50 / 60 Hz)
Max. continuous operating voltage (a.c.) (U_C)	600 V (50 / 60 Hz)
Rated varistor voltage (U_{mov})	750 V
Nominal discharge current (8/20 μ s) (I_n)	15 kA
Max. discharge current (8/20 μ s) (I_{max})	25 kA
Voltage protection level (U_p)	≤ 3 kV
Voltage protection level at 5 kA (U_p)	≤ 2.5 kV
Response time (t_A)	≤ 25 ns
Max. mains-side overcurrent protection	100 A gG
Short-circuit withstand capability for max. mains-side overcurrent protection (I_{SCCR})	25 kA _{rms}
Temporary overvoltage (TOV) (U_T) – Characteristic	900 V / 5 sec. – withstand
Temporary overvoltage (TOV) (U_T) – Characteristic	915 V / 120 min. – safe failure
Operating temperature range (T_U)	-40 °C ... +80 °C
Operating state / fault indication	green / red
Number of ports	1
Cross-sectional area (min.)	1.5 mm ² solid / flexible
Cross-sectional area (max.)	35 mm ² stranded / 25 mm ² flexible
For mounting on	35 mm DIN rails acc. to EN 60715
Enclosure material	thermoplastic, red, UL 94 V-0
Place of installation	indoor installation
Degree of protection	IP 20
Capacity	3 module(s), DIN 43880
Approvals	KEMA, UL
Type of remote signalling contact	changeover contact
Switching capacity (a.c.)	250 V / 0.5 A
Switching capacity (d.c.)	250 V / 0.1 A; 125 V / 0.2 A; 75 V / 0.5 A
Cross-sectional area for remote signalling terminals	max. 1.5 mm ² solid / flexible
Weight	388 g
Customs tariff number (Comb. Nomenclature EU)	85363030
GTIN	4013364113312
PU	1 pc(s)

DEHNguard

DG M TNC CI 275 FM (952 309)

- Arrester backup fuse integrated in the protection module
- Prewired complete unit consisting of a base part and plug-in protection modules
- High reliability due to "Thermo Dynamic Control" SPD monitoring device



Figure without obligation

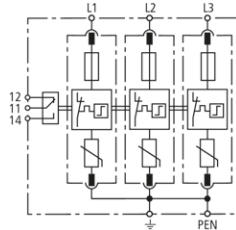

Basic circuit diagram DG M TNC CI 275 FM

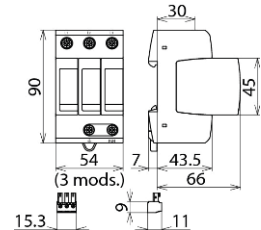

Dimension drawing DG M TNC CI 275 FM

Modular surge arrester with integrated backup fuses for TN-C systems.

Type	DG M TNC CI 275 FM
Part No.	952 309
SPD according to EN 61643-11 / IEC 61643-11	type 2 / class II
Energy coordination with terminal equipment (≤ 10 m)	type 2 + type 3
Nominal a.c. voltage (U_N)	230 / 400 V (50 / 60 Hz)
Max. continuous operating voltage (a.c.) (U_C)	275 V (50 / 60 Hz)
Nominal discharge current (8/20 μ s) (I_n)	12.5 kA
Max. discharge current (8/20 μ s) (I_{max})	25 kA
Voltage protection level (U_P)	≤ 1.5 kV
Voltage protection level at 5 kA (U_P)	≤ 1 kV
Response time (t_A)	≤ 25 ns
Max. mains-side overcurrent protection	not required
Rated breaking capacity of the internal backup protection	25 kA
Short-circuit withstand capability (I_{SCCR})	25 kA _{rms}
Temporary overvoltage (TOV) (U_T) – Characteristic	335 V / 5 sec. – withstand
Temporary overvoltage (TOV) (U_T) – Characteristic	440 V / 120 min. – safe failure
Operating temperature range (T_U)	-40 °C ... +80 °C
Operating state / fault indication	green / red
Number of ports	1
Cross-sectional area (min.)	1.5 mm ² solid / flexible
Cross-sectional area (max.)	35 mm ² stranded / 25 mm ² flexible
For mounting on	35 mm DIN rails acc. to EN 60715
Enclosure material	thermoplastic, red, UL 94 V-0
Place of installation	indoor installation
Degree of protection	IP 20
Capacity	3 module(s), DIN 43880
Approvals	KEMA, VDE
Type of remote signalling contact	changeover contact
Switching capacity (a.c.)	250 V / 0.5 A
Switching capacity (d.c.)	250 V / 0.1 A; 125 V / 0.2 A; 75 V / 0.5 A
Cross-sectional area for remote signalling terminals	max. 1.5 mm ² solid / flexible
Weight	382 g
Customs tariff number (Comb. Nomenclature EU)	85363030
GTIN	4013364128378
PU	1 pc(s)

DEHNmid

DMI 9 10 1 L (990 003)

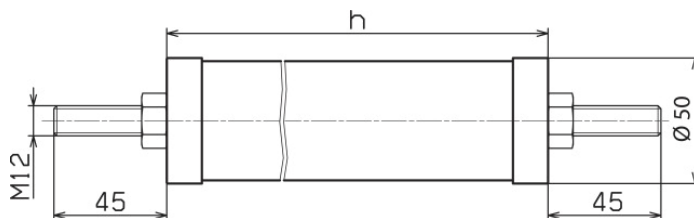

Figure without obligation

Dimension drawing DMI 9 10 1 L

Type Part No.	DMI 9 10 1 L 990 003
Nominal discharge current (8/20 μ s) (I_n)	10 kA
High current impulse (4/10 μ s)	100 kA
Overload capacity	20 kA
Line discharge class (1)	1 (2.8 kJ/kV U_{lr})
Long-duration current impulse (1)	250 A / 2000 μ s
Line discharge class (2)	2 (4.5 kJ/kV U_{lr})
Long-duration current impulse (2)	500 A / 2000 μ s
Rated voltage (a.c.) (U_r)	9 kV
Continuous operating voltage (a.c.) (MCOV) (U_c)	7.2 kV
Temporary overvoltage (TOV) at 1 sec. (U_{1s})	10.4 kV
Temporary overvoltage (TOV) at 10 sec. (U_{10s})	9.8 kV
Residual voltage at 10 kA (1/2 μ s) (\hat{u}_{res})	28.9 kV
Residual voltage at 5 kA (8/20 μ s) (\hat{u}_{res})	25.1 kV
Residual voltage at 10 kA (8/20 μ s) (\hat{u}_{res})	27.0 kV
Residual voltage at 20 kA (8/20 μ s) (\hat{u}_{res})	30.0 kV
Residual voltage at 40 kA (8/20 μ s) (\hat{u}_{res})	33.8 kV
Residual voltage at 125 A (40/100 μ s) (\hat{u}_{res})	19.7 kV
Residual voltage at 250 A (40/100 μ s) (\hat{u}_{res})	20.3 kV
Residual voltage at 500 A (40/100 μ s) (\hat{u}_{res})	21.1 kV
Residual voltage at 1000 A (40/100 μ s) (\hat{u}_{res})	21.9 kV
Residual voltage at 2000 A (40/100 μ s) (\hat{u}_{res})	23.0 kV
Insulation of arrester housing / nominal power frequency withstand voltage (dry) (U_{PFWL})	40 kV
Insulation of arrester housing / nominal lightning withstand voltage (U_{LiWL})	58 kV
Height (h)	132 mm
Creepage distance (+/- 5%)	108 mm
Torsional strength	78 Nm
Maximum permissible dynamic service load (MPDSL)	230 Nm
Tensile strength	1400 N
Ambient temperature (T_A)	-40 °C ... +55 °C
Altitude	up to 1000 m above sea level
Power frequency (f_N)	16-62 Hz
Housing material	HTV silicone housing
Colour	auburn, RAL 3013
Fittings	terminals, screws and nuts of stainless steel
Conductor clamp	up to \varnothing 16 mm
Test standards	IEC 60099-4
Weight	1 kg
Customs tariff number (Comb. Nomenclature EU)	85354000
GTIN	4013364102606
PU	1 pc(s)

DEHNmid

DMI 36 10 1 L (990 013)

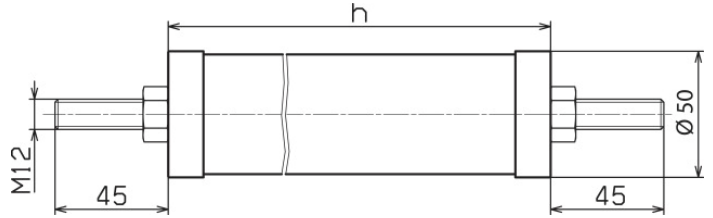

Figure without obligation

Dimension drawing DMI 36 10 1 L

Type	DMI 36 10 1 L
Part No.	990 013
Nominal discharge current (8/20 μ s) (I_n)	10 kA
High current impulse (4/10 μ s)	100 kA
Overload capacity	20 kA
Line discharge class (1)	1 (2.8 kJ/kV U_r)
Long-duration current impulse (1)	250 A / 2000 μ s
Line discharge class (2)	2 (4.5 kJ/kV U_r)
Long-duration current impulse (2)	500 A / 2000 μ s
Rated voltage (a.c.) (U_r)	36 kV
Continuous operating voltage (a.c.) (MCOV) (U_c)	28.8 kV
Temporary overvoltage (TOV) at 1 sec. (U_{1s})	41.4 kV
Temporary overvoltage (TOV) at 10 sec. (U_{10s})	39.2 kV
Residual voltage at 10 kA (1/2 μ s) (\hat{u}_{res})	104.9 kV
Residual voltage at 5 kA (8/20 μ s) (\hat{u}_{res})	91.1 kV
Residual voltage at 10 kA (8/20 μ s) (\hat{u}_{res})	98.0 kV
Residual voltage at 20 kA (8/20 μ s) (\hat{u}_{res})	108.8 kV
Residual voltage at 40 kA (8/20 μ s) (\hat{u}_{res})	122.5 kV
Residual voltage at 125 A (40/100 μ s) (\hat{u}_{res})	71.5 kV
Residual voltage at 250 A (40/100 μ s) (\hat{u}_{res})	73.8 kV
Residual voltage at 500 A (40/100 μ s) (\hat{u}_{res})	76.4 kV
Residual voltage at 1000 A (40/100 μ s) (\hat{u}_{res})	79.4 kV
Residual voltage at 2000 A (40/100 μ s) (\hat{u}_{res})	83.3 kV
Insulation of arrester housing / nominal power frequency withstand voltage (dry) (U_{PFWL})	118 kV
Insulation of arrester housing / nominal lightning withstand voltage (U_{LIWL})	170 kV
Height (h)	362 mm
Creepage distance (+/- 5%)	338 mm
Torsional strength	78 Nm
Maximum permissible dynamic service load (MPDSL)	230 Nm
Tensile strength	1400 N
Ambient temperature (T_a)	-40 °C ... +55 °C
Altitude	up to 1000 m above sea level
Power frequency (f_N)	16-62 Hz
Housing material	HTV silicone housing
Colour	auburn, RAL 3013
Fittings	terminals, screws and nuts of stainless steel
Conductor clamp	up to Ø16 mm
Test standards	IEC 60099-4
Weight	3 kg
Customs tariff number (Comb. Nomenclature EU)	85354000
GTIN	4013364102705
PU	1 pc(s)

BLITZDUCTOR XT

BXT ML2 BE S 24 (920 224)

- LifeCheck SPD monitoring function
- Optimal protection of two single lines and the cable shield
- For use in conformity with the lightning protection zone concept at the boundaries from $0_A -2$ and higher



Figure without obligation

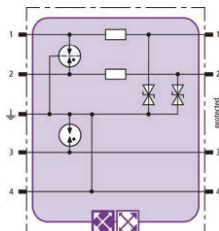

Basic circuit diagram BXT ML2 BE S 24

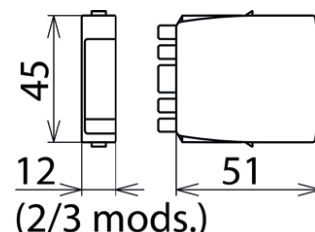

Dimension drawing BXT ML2 BE S 24

Space-saving combined lightning current and surge arrester module with LifeCheck feature for protecting two single lines sharing a common reference potential as well as unbalanced interfaces, with direct or indirect shield earthing. If LifeCheck detects thermal or electrical overload, the arrester has to be replaced. This status is indicated contactlessly by the DEHNrecord LC / SCM / MCM reader.

Type	BXT ML2 BE S 24
Part No.	920 224
SPD monitoring system	LifeCheck
SPD class	TYPE 1 P_A
Nominal voltage (U_N)	24 V
Max. continuous operating voltage (d.c.) (U_c)	33 V
Max. continuous operating voltage (a.c.) (U_c)	23.3 V
Nominal current at 45 °C (I_L)	0.75 A
D1 Total lightning impulse current (10/350 μ s) (I_{imp})	9 kA
D1 Lightning impulse current (10/350 μ s) per line (I_{imp})	2.5 kA
C2 Total nominal discharge current (8/20 μ s) (I_n)	20 kA
C2 Nominal discharge current (8/20 μ s) per line (I_n)	10 kA
Voltage protection level line-line for I_{imp} D1 (U_p)	≤ 102 V
Voltage protection level line-PG for I_{imp} D1 (U_p)	≤ 66 V
Voltage protection level line-line at 1 kV/ μ s C3 (U_p)	≤ 90 V
Voltage protection level line-PG at 1 kV/ μ s C3 (U_p)	≤ 45 V
Series resistance per line	1.8 ohm(s)
Cut-off frequency line-PG (f_c)	6.8 MHz
Capacitance line-line (C)	≤ 0.5 nF
Capacitance line-PG (C)	≤ 1.0 nF
Operating temperature range (T_U)	-40 °C ... +80 °C
Degree of protection (with plugged-in protection module)	IP 20
Pluggable into	BXT BAS / BSP BAS 4 base part
Earthing via	BXT BAS / BSP BAS 4 base part
Enclosure material	polyamide PA 6.6
Colour	yellow
Test standards	IEC 61643-21 / EN 61643-21, UL 497B
Approvals	CSA, EAC, ATEX, IECEx, CSA & USA Hazloc, SIL
SIL classification	up to SIL3 [*]
ATEX approvals	DEKRA 11ATEX0089 X: II 3 G Ex nA IIC T4 Gc
IECEx approvals	DEK 11.0032X: Ex nA IIC T4 Gc
CSA & USA Hazloc approvals (1)	2516389: Class I Div. 2 GP A, B, C, D T4
CSA & USA Hazloc approvals (2)	2516389: Class I Zone 2, AEx nA IIC T4
Weight	37 g
Customs tariff number (Comb. Nomenclature EU)	85363010
GTIN	4013364117785
PU	1 pc(s)

*For more detailed information, please visit www.dehn-international.com.

BLITZDUCTOR XT

BXT ML4 BE 24 (920 324)

- LifeCheck SPD monitoring function
- Optimal protection of four single lines
- For installation in conformity with the lightning protection zone concept at the boundaries from $0_A - 2$ and higher



Figure without obligation

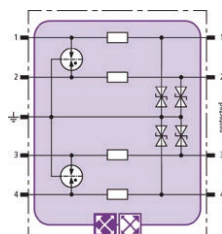

Basic circuit diagram BXT ML4 BE 24

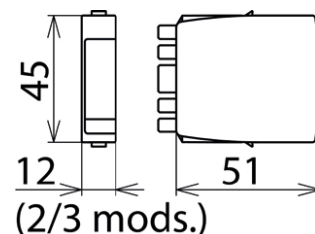

Dimension drawing BXT ML4 BE 24

Space-saving combined lightning current and surge arrester module with LifeCheck feature for protecting four single lines sharing a common reference potential as well as unbalanced interfaces. If LifeCheck detects thermal or electrical overload, the arrester has to be replaced. This status is indicated contactlessly by the DEHNrecord LC / SCM / MCM reader.

Type	BXT ML4 BE 24
Part No.	920 324
SPD monitoring system	LifeCheck
SPD class	TYPE 1 PD
Nominal voltage (U_N)	24 V
Max. continuous operating voltage (d.c.) (U_c)	33 V
Max. continuous operating voltage (a.c.) (U_c)	23.3 V
Nominal current at 45 °C (I_L)	0.75 A
D1 Total lightning impulse current (10/350 μ s) (I_{imp})	10 kA
D1 Lightning impulse current (10/350 μ s) per line (I_{imp})	2.5 kA
C2 Total nominal discharge current (8/20 μ s) (I_n)	20 kA
C2 Nominal discharge current (8/20 μ s) per line (I_n)	10 kA
Voltage protection level line-line for I_{imp} D1 (U_p)	≤ 102 V
Voltage protection level line-PG for I_{imp} D1 (U_p)	≤ 66 V
Voltage protection level line-line at 1 kV/ μ s C3 (U_p)	≤ 90 V
Voltage protection level line-PG at 1 kV/ μ s C3 (U_p)	≤ 45 V
Series resistance per line	1.8 ohm(s)
Cut-off frequency line-PG (f_c)	6.8 MHz
Capacitance line-line (C)	≤ 0.5 nF
Capacitance line-PG (C)	≤ 1.0 nF
Operating temperature range (T_U)	-40 °C ... +80 °C
Degree of protection (with plugged-in protection module)	IP 20
Pluggable into	BXT BAS / BSP BAS 4 base part
Earthing via	BXT BAS / BSP BAS 4 base part
Enclosure material	polyamide PA 6.6
Colour	yellow
Test standards	IEC 61643-21 / EN 61643-21, UL 497B
Approvals	CSA, UL, EAC, ATEX, IECEx, CSA & USA Hazloc, SIL
SIL classification	up to SIL3 ^{*)}
ATEX approvals	DEKRA 11ATEX0089 X: II 3 G Ex nA IIC T4 Gc
IECEx approvals	DEK 11.0032X: Ex nA IIC T4 Gc
CSA & USA Hazloc approvals (1)	2516389: Class I Div. 2 GP A, B, C, D T4
CSA & USA Hazloc approvals (2)	2516389: Class I Zone 2, AEx nA IIC T4
Weight	38 g
Customs tariff number (Comb. Nomenclature EU)	85363010
GTIN	4013364109056
PU	1 pc(s)

^{*)} For more detailed information, please visit www.dehn-international.com.

BLITZDUCTOR XT

BXT BAS (920 300)

- Four-pole version for universal use with all types of BSP and BXT / BXTU protection modules
- No signal interruption if the protection module is removed
- Universal design without protection elements



Figure without obligation

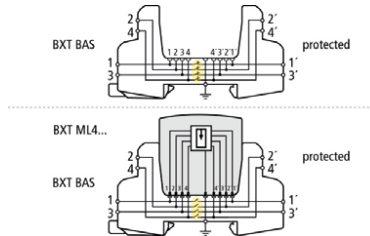

Basic circuit diagram with and without plugged-in module

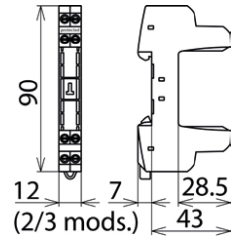

Dimension drawing BXT BAS

The BLITZDUCTOR XT base part is an extremely space-saving and universal four-pole feed-through terminal for the insertion of a protection module without signal disconnection if the protection module is removed. The snap-in mechanism at the supporting foot of the base part allows the protection module to be safely earthed via the DIN rail. Since no components of the protective circuit are situated in the base part, maintenance is only required for the protection modules.

Type Part No.	BXT BAS 920 300
Operating temperature range (T _U)	-40 °C ... +80 °C
Degree of protection	IP 20
For mounting on	35 mm DIN rails acc. to EN 60715
Connection (input / output)	screw / screw
Signal disconnection	no
Cross-sectional area, solid	0.08-4 mm ²
Cross-sectional area, flexible	0.08-2.5 mm ²
Tightening torque (terminals)	0.4 Nm
Earthing via	35 mm DIN rails acc. to EN 60715
Enclosure material	polyamide PA 6.6
Colour	yellow
ATEX approvals	DEKRA 11ATEX0089 X: II 3 G Ex nA IIC T4 Gc ^{*)}
IECEX approvals	DEK 11.0032X: Ex nA IIC T4 Gc ^{*)}
Approvals	CSA, UL, EAC, ATEX, IECEx ^{*)}
Weight	34 g
Customs tariff number (Comb. Nomenclature EU)	85369010
GTIN	4013364109179
PU	1 pc(s)

^{*)} only in connection with an approved protection module

DEHNpatch

DPA M CLE RJ45B 48 (929 121)

- Ideally suited for retrofitting, protection of all lines
- Cat. 6 in the channel (class E)
- Power over Ethernet IEEE 802.3 compliant (up to PoE++ / 4PPoE)
- For installation in conformity with the lightning protection zone concept at the boundaries from $0_B -2$ and higher



Figure without obligation

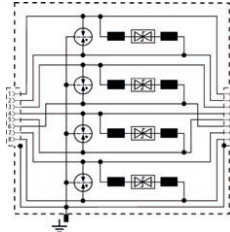

Basic circuit diagram DPA M CLE RJ45B 48

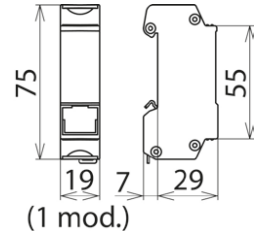

Dimension drawing DPA M CLE RJ45B 48

Universal arrester for Industrial Ethernet, Power over Ethernet (IEEE 802.3 compliant up to PoE++ / 4PPoE) and similar applications in structured cabling systems according to class E up to 250 MHz. Protection of all pairs by means of powerful gas discharge tubes and one adapted filter matrix per pair. Fully shielded type with sockets for DIN rail mounting (up to 1 Gbit Ethernet).

Type	DPA M CLE RJ45B 48
Part No.	929 121
SPD class	TYPE 2 Pt
Nominal voltage (U_N)	48 V
Max. continuous operating voltage (d.c.) (U_c)	48 V
Max. continuous operating voltage (a.c.) (U_c)	34 V
Max. continuous operating voltage (d.c.) pair-pair (PoE) (U_c)	57 V
Nominal current (I_N)	1 A
D1 Lightning impulse current (10/350 μ s) per line (I_{imp})	0.5 kA
C2 Nominal discharge current (8/20 μ s) line-line (I_n)	150 A
C2 Nominal discharge current (8/20 μ s) line-PG (I_n)	2.5 kA
C2 Nominal discharge current (8/20 μ s) total (I_n)	10 kA
C2 Nominal discharge current (8/20 μ s) pair-pair (PoE) (I_n)	150 A
Voltage protection level line-line for I_n C2 (U_p)	≤ 180 V
Voltage protection level line-PG for I_n C2 (U_p)	≤ 500 V
Voltage protection level line-line for I_n C2 (PoE) (U_p)	≤ 600 V
Voltage protection level line-line at 1 kV/ μ s C3 (U_p)	≤ 180 V
Voltage protection level line-PG at 1 kV/ μ s C3 (U_p)	≤ 500 V
Voltage protection level pair-pair at 1 kV/ μ s C3 (PoE) (U_p)	≤ 600 V
Cut-off frequency (f_c)	250 MHz
Insertion loss at 250 MHz	≤ 3 dB
Capacitance line-line (C)	≤ 30 pF
Capacitance line-PG (C)	≤ 25 pF
Operating temperature range (T_u)	-40 °C ... +80 °C
Degree of protection	IP 10
For mounting on	35 mm DIN rails acc. to EN 60715
Connection (input / output)	RJ45 socket / RJ45 socket
Pinning	1/2, 3/6, 4/5, 7/8
Earthing via	35 mm DIN rail acc. to EN 60715
Enclosure material	zinc die-casting
Colour	bare surface
Test standards	IEC 61643-21 / EN 61643-21 / UL 497B
Approvals	CSA, UL, GHMT, EAC
External accessories	fixing material
Weight	109 g
Customs tariff number (Comb. Nomenclature EU)	85363010
GTIN	4013364118935
PU	1 pc(s)

Air-termination rod

RFS 16 10 3000 V2A (103 449)



Figure without obligation

Tubular air-termination rod with tapering (1000 mm), light design, chamfered, to protect roof-mounted structures, chimneys etc., especially for concrete base (17 kg) for wedge mounting or fixing with rod holders / spacers.

Type	RFS 16 10 3000 V2A
Part No.	103 449
Total length (l1)	3000 mm
Reduced length	1000 mm
Material	StSt
Diameter Ø	16 / 10 mm
Wall thickness of pipe (t1)	3 mm
Standard	EN 62561-2
Weight	2,57 kg
Customs tariff number (Comb. Nomenclature EU)	85389099
GTIN	4013364128798
PU	10 pc(s)

Equipotential bonding bar



PAS I 6AP M10 V2A (472 209)



Figure without obligation

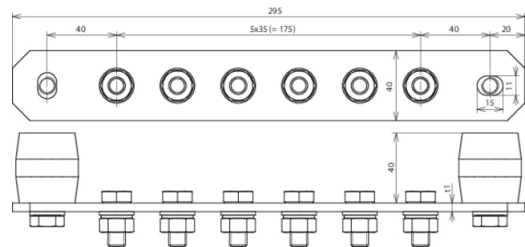

Type	PAS I 6AP M10 V2A
Part No.	472 209
Quantity of terminals	6
Material	StSt
Material No.	1.4301 / 1.4303
Dimension (l x w x d1)	295 x 40 x 6 mm
Cross-section	240 mm ²
Short-circuit current (50 Hz) (1 s; ≤ 300 °C)	8.9 kA
Screw	● M10 x 25 mm
Material of screw / nut	StSt
Design	with spring washer
Material of insulator	UP
Colour of insulator	red ●
Standard	EN 62561-1
Weight	1,01 kg
Customs tariff number (Comb. Nomenclature EU)	85389099
GTIN	4013364090934
PU	1 pc(s)

Fixed earthing terminal

 **EFPM M10 12 V4A L230 STTZN (478 011)**



Figure without obligation

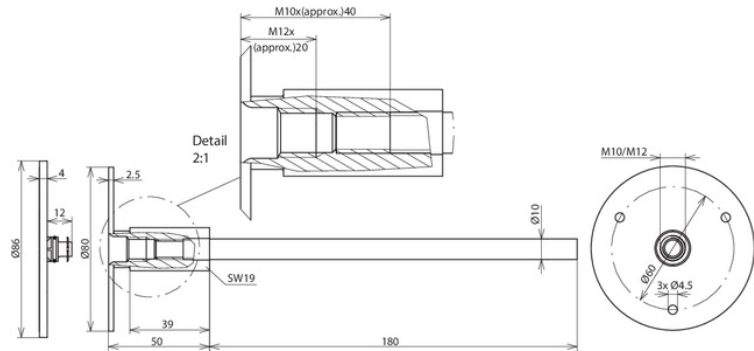

Type	EFPM M10 12 V4A L230 STTZN
Part No.	478 011
Connection thread	M10 / M12
Material of plate	StSt (V4A)
Material No.	1.4571 / 1.4404 / 1.4401
ASTM / AISI:	316Ti / 316L / 316
Material of axis	St/tZn
Connection plate Ø	80 mm
Dimension of connection axis (Ø / length)	10 / 180 mm
Short-circuit current (50 Hz) (1 s; ≤ 300 °C)	6.5 kA
Standard	EN 62561-1
UL approval	UL467
Minimum lengths of screws M10	35 mm (thread length 40 mm)
Minimum lengths of screws M12	15 mm (thread length 20 mm)
Weight	301 g
Customs tariff number (Comb. Nomenclature EU)	85389099
GTIN	4013364033054
PU	10 pc(s)

Pipe clamp

BRS 50.300 BB16 8 V2A (540 105)



Figure without obligation

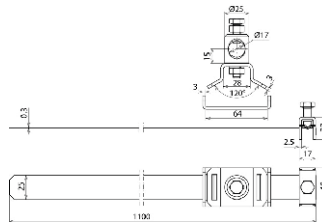

Type	BRS 50.300 BB16 8 V2A
Part No.	540 105
Material of head / strip	StSt
Clamping range of square hollow profile	40 x 60 to 70 x 70 mm
Clamping range of pipe	50-300 mm
Connection Rd	16 mm
Dimension of strip	1100 x 25 x 0.3 mm
Material of connecting bolt	StSt
Screw	⚙ M8 x 20 mm
Material of screw	StSt
Standard	EN 62561-1
Dimension of strip	25 x 0.3 mm
Weight	359 g
Customs tariff number (Comb. Nomenclature EU)	85389099
GTIN	4013364115880
PU	1 pc(s)

Cross unit

KS 8.10 8.10 FL30 ZP V4A (319 209)



Figure without obligation

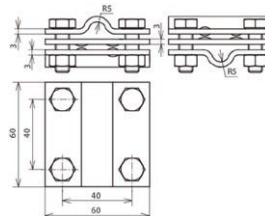

Type	KS 8.10 8.10 FL30 ZP V4A
Part No.	319 209
Material of clamp	StSt (V4A)
Clamping range Rd / Rd	8-10 / 8-10 mm
Clamping range Rd / FI	8-10 / 30 mm
Clamping range FI / FI	30 / 30 mm
Clamping range (stranded / cable)	50-70 mm ²
Screw	⚙ M8 x 25 mm
Material of screw / nut	StSt (V4A)
Material No.	1.4571 / 1.4404 / 1.4401
ASTM / AISI:	316Ti / 316L / 316
Dimension	60 x 60 x 3 mm
Intermediate plate	yes
Standard	EN 62561-1
Short-circuit current (50 Hz) (1 s; ≤ 300 °C)	7 kA
Weight	313 g
Customs tariff number (Comb. Nomenclature EU)	85389099
GTIN	4013364035980
PU	25 pc(s)

U-clamp

VK DB 6.20 8.10 FL30 BSB STBL (308 031)



Figure without obligation

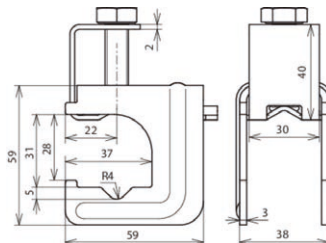

Type	VK DB 6.20 8.10 FL30 BSB STBL
Part No.	308 031
Material	St/bare
Clamping range Rd / Rd	(+II) 6-20 / 8-10 mm
Clamping range Rd / FI	(+II) 6-20 / 30 x 3-4 mm
Clamping range FI / FI	(+II) 30 x 3-4 / 30 x 3-4 mm
Screw	 M10 x 35 mm
Material of screw	St/bare
Short-circuit current (50 Hz) (1 s; ≤ 300 °C)	8.4 kA
Standard	EN 62561-1
Weight	230 g
Customs tariff number (Comb. Nomenclature EU)	85389099
GTIN	4013364136571
PU	25 pc(s)

MAXI MV clamp

MAMVK 8.16 15.25 STBL (308 040)



Figure without obligation

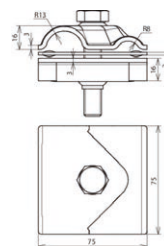

Type	MAMVK 8.16 15.25 STBL
Part No.	308 040
Material	St/bare
Clamping range Rd / Rd	(+II) 8-16 / 15-25 mm
Screw	 M12 x 65 mm
Material of screw	St/bare
Short-circuit current (50 Hz) (1 s; ≤ 300 °C)	10.2 kA
Standard	EN 62561-1
UL certification	UL467B
Weight	450 g
Customs tariff number (Comb. Nomenclature EU)	85389099
GTIN	4013364055902
PU	20 pc(s)

Strip

BA 30X3.5 STTZN R50M (810 335)



Figure without obligation

Steel strip according to EN 62561-2 with zinc coating $\geq 70 \mu\text{m}$ average (about 500 g/m^2), for use in lightning protection and earth-termination systems.

Type	BA 30X3.5 STTZN R50M
Part No.	810 335
Width	30 mm
Thickness	3.5 mm
Cross-section	105 mm^2
Material	St/tZn
Standard	EN 62561-2
Zinc coating	$\geq 70 \mu\text{m}$ average (about 500 g/m^2)
Conductivity	$\geq 6.66 \text{ m} / \text{Ohm mm}^2$
Resistivity	$\leq 0.15 \text{ Ohm mm}^2 / \text{m}$
Short-circuit current (50 Hz) (1 s; $\leq 300 \text{ }^\circ\text{C}$)	7.3 kA
Weight	840 g/m
Customs tariff number (Comb. Nomenclature EU)	72123000
GTIN	4013364032880
PU	50 m

Round wire

RD 10 V4A R80M (860 010)

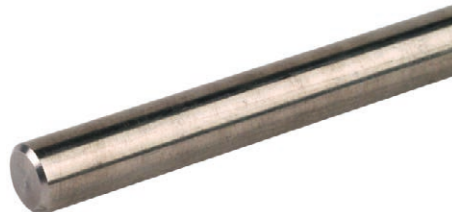

Figure without obligation

Stainless steel wire according to EN 62561-2, for use in lightning protection and earth-termination systems or equipotential bonding.

Stainless steel wire for use in soil has to be made of StSt (V4A) with a molybdenum proportion $> 2 \%$ e.g. 1.4571, 1.4404, in accordance with EN 62561-2 and IEC/EN 62305-3.

Type	RD 10 V4A R80M
Part No.	860 010
Diameter \varnothing conductor	10 mm
Cross-section	78 mm^2
Material	StSt (V4A)
Material No.	1.4571 / 1.4404
ASTM / AISI:	316Ti / 316L
Standard	based on EN 62561-2
Conductivity	$\geq 1.25 \text{ m} / \text{Ohm mm}^2$
Resistivity	$\leq 0.8 \text{ Ohm mm}^2 / \text{m}$
Short-circuit current (50 Hz) (1 s; $\leq 300 \text{ }^\circ\text{C}$)	2.9 kA
Weight	617 g/m
Customs tariff number (Comb. Nomenclature EU)	72210010
GTIN	4013364019997
PU	80 m

Surge Protection
Lightning Protection
Safety Equipment
DEHN protects.

DEHN SE
Hans-Dehn-Str. 1
Postfach 1640
92306 Neumarkt, Germany

Tel. +49 9181 906-0
Fax +49 9181 906-1100
info@dehn.de
www.dehn-international.com



www.dehn-international.com/partners

Type designations of products mentioned in this white paper which are at the same time registered trademarks are not especially marked. Hence the absence of TM or [®] markings does not indicate that the type designation is a free trade name. Nor can it be seen whether patents or utility models and other intellectual and industrial property rights exist. We reserve the right to introduce changes in performance, configuration and technology, dimensions, weights and materials in the course of technical progress. The figures are shown without obligation. Misprints, errors and modifications excepted. Reproduction in any form whatsoever is forbidden without our authorisation.